

# RADIO — ELECTRONICS

OCTOBER 1952

LATEST IN TELEVISION • SERVICING • AUDIO



HUGO GERNSBACK, Editor

**38-FOOT AUDIO TRAILER  
BRINGS HI-FI TO CUSTOMER**

See page 4

**30¢**

U. S. and  
CANADA

**In this issue: Grounded-Grid Audio Amplifiers •  
Conversion for U.H.F. TV • Picture Tube Analyzer**

# REVOLUTIONARY



**NEW!**

**Extra long-playing**

**"Personal" type RCA radio batteries**

These RCA long-life batteries have completely revolutionized the design and performance of "personal" type portable radios. They've opened up a brand-new replacement market for you that *never before existed*.

Think of it . . . the revolutionary, new RCA VS216, 67½-volt "B" Battery plays newly designed "personal" type portable radios *twice* as long as ordinary 67½-volt batteries. The new, companion RCA VS236 1½-volt "A" Battery (size G) provides up to *five times* the life of ordinary "A" batteries (size D).

New "personal" type portable radios designed to use one VS216 and two VS236 batteries can play up to *10 times longer without a battery change* than previous models using one 67½-volt "B" battery and one 1½-volt "A" bat-

tery of the ordinary type. This new battery complement offers savings in battery operating cost of as much as 25%!

Secret of the longer useful life of the new RCA VS216 "B" Battery is its use of "crown-type," alkaline dry cells. These cells use their active ingredients more effectively than do ordinary cells—resulting in greatly increased playing time.

The new RCA Victor Super "Personal" radio, model 2B400 series, has been designed to use the new RCA "balanced-life" battery complement. Tens of thousands of these as well as other makes of new "personal" type portables have been sold all over the country, creating a *ready-made* battery replacement business for you. It's alive, real and profitable today . . . ACT NOW. TMK®



**RADIO CORPORATION of AMERICA**  
**RADIO BATTERIES**  
**HARRISON, N. J.**



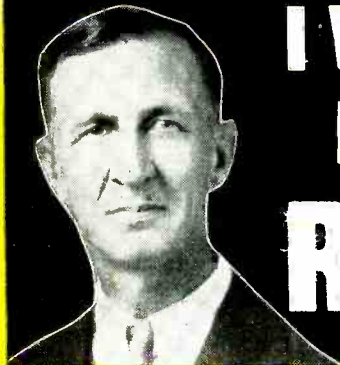

# I WILL TRAIN YOU AT HOME FOR GOOD PAY JOBS IN RADIO-TELEVISION

J. E. SMITH has trained more men for Radio-Television than any other man.

## America's Fast Growing Industry Offers You

**2 FREE BOOKS SHOW HOW MAIL COUPON**

### I TRAINED THESE MEN

**LOST JOB, NOW HAS OWN SHOP**  
"Got laid off my machine shop job which I believe was best thing ever happened as I opened a full time Radio Shop. Business is picking up every week."—E. T. Slate, Corsicana, Texas.

**GOOD JOB WITH STATION**  
"I am Broadcast Engineer at WLPN. Another technician and I have opened a Radio-TV service shop in our spare time. Big TV sales here... more work than we can handle."—J. H. Bangley, Suffolk, Va.

**\$10 TO \$15 WEEK SPARE TIME**  
"Four months after enrolling for NRI course, was able to service Radios... averaged \$10 to \$15 a week spare time. Now have full time Radio and Television business."—William Weyde, Brooklyn, New York.

**SWITCHED TO TV SERVICING**  
"I recently switched over from studio work and am now holding a position as service technician. I am still with RCA, enjoying my work more and more every day."—N. Ward, Ridgely, N.J.

**WANT YOUR OWN BUSINESS?**  
Let me show you how you can be your own boss. Many NRI trained men start their own business with capital earned in spare time. Robert Dohmen, New Prague, Minn., whose store is shown at left, says, "Am now tied in with two Television outfits and do warranty work for dealers. Often call back to NRI textbooks for information"



### 1. EXTRA MONEY IN SPARE TIME

Many students make \$5, \$10 a week and more EXTRA fixing neighbors' Radios in spare time while learning. The day you enroll I start sending you SPECIAL BOOKLETS that show you how. Tester you build with kits I send helps you make extra money servicing sets, gives practical experience on circuits common to Radio and Television. All equipment is yours to keep.

### 2. GOOD PAY JOB

NRI Courses lead to these and many other jobs: Radio and TV service, P.A., Auto Radio, Lab, Factory, and Electronic Controls Technicians, Radio and TV Broadcasting, Police, Ship and Airways Operators and Technicians. Opportunities are increasing. The United States has over 105 million Radios—over 2,900 Broadcasting Stations—more expansion is on the way.

### 3. BRIGHT FUTURE

Think of the opportunities in Television. Over 15,000,000 TV sets are now in use; 103 TV stations are operating and 1800 new TV stations have been authorized... many of them expected to be in operation in 1953. This means more jobs—good pay jobs with bright futures. More operators, installation service technicians will be needed. Now is the time to get ready for a successful future in TV! Find out what Radio and TV offer you.

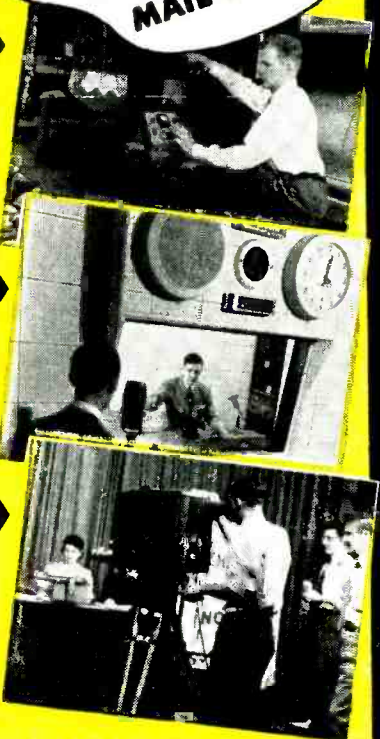

## You Learn Servicing or Communications by Practicing With Kits I Send

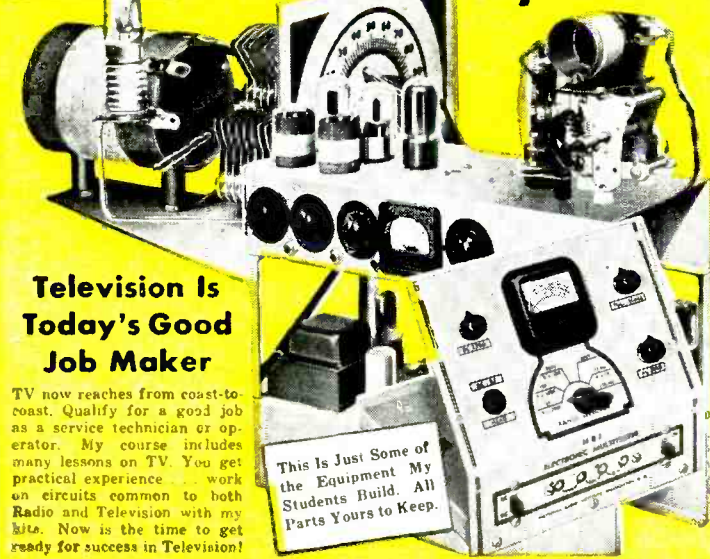

### Television Is Today's Good Job Maker

TV now reaches from coast-to-coast. Qualify for a good job as a service technician or operator. My course includes many lessons on TV. You get practical experience... work on circuits common to both Radio and Television with my kits. Now is the time to get ready for success in Television!

This Is Just Some of the Equipment My Students Build. All Parts Yours to Keep.

Keep your job while training at home. Hundreds I've trained are successful RADIO-TELEVISION Technicians. Most had no previous experience; many no more than grammar school education. Learn Radio-Television principles from illustrated lessons. You also get PRACTICAL EXPERIENCE. Pictured at left are just a few of the pieces of equipment you build with kits of parts I send. You experiment with, learn circuits common to Radio and Television.

Mail Coupon—find out what RADIO-TELEVISION Can Do for You  
Act Now! Send for my FREE DOUBLE OFFER. Coupon entitles you to actual Servicing Lesson; shows how you learn at home. You'll also receive my 64-page book, "How to Be a Success in Radio-Television." Send coupon in envelope or paste or postal. J. E. SMITH, Pres., Dept. 2KF, National Radio Institute, Washington 9, D. C. Our 39th Year

### Good for Both—FREE

Mr. J. E. Smith, President, Dept. 2KF  
National Radio Institute, Washington 9, D. C.  
Mail me Sample Lesson and 64-page Book, "How to Be a Success in Radio-Television." Both FREE. (No salesman will call. Please write plainly.)

Name..... Age.....  
Address.....  
City..... Zone..... State.....  
Approved under G.I. Bill

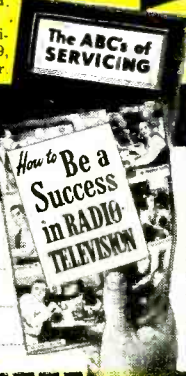

# RADIO - ELECTRONICS

Formerly RADIO-CRAFT • Incorporating SHORT WAVE CRAFT • TELEVISION NEWS • RADIO & TELEVISION\*

Hugo Gernsback  
Editor-in-Chief

M. Harvey Gernsback  
Editorial Director

Fred Shunaman  
Managing Editor

Robert F. Scott  
W2PWG, Technical Editor

Mortimer Bernstein  
Associate Editor

I. Queen  
Editorial Associate

Angie Pascale  
Production Manager

Wm. Lyon McLaughlin  
Tech. Illustration Director

Sol Ehrlich  
Art Director

Lee Robinson  
General Manager

John J. Lamson  
Sales Manager

G. Aliquo  
Circulation Manager

Robert Fallath  
Promotion Manager



**ON THE COVER** (See page 50)  
The new sound trailer which  
Electro-Voice uses to bring  
music to areas which are not  
served by dealer's demonstra-  
tion rooms.  
Color original courtesy of  
Electro-Voice, Inc.



MEMBER Audit Bureau of Circulations

Vol. XXIII, No. 13

## CONTENTS

OCTOBER 1952

Cover Feature .....	50
<b>Editorial (Page 29)</b>	
Our Electronic Universe .....	29
<b>Television (Pages 30-43)</b>	
Converters for U.H.F. TV .....	30
TV DX Reports .....	32
Converting a Set with R.F. Supply .....	33
The Eidophor Projector .....	34
Picture Tube Analyzer .....	36
High-Voltage Service Hints .....	38
Eliminating Those Nuisance Service Calls .....	40
TV Service Clinic .....	42
<b>Electronics (Pages 44-45)</b>	
Cosmotron .....	44
<b>Audio (Pages 46-54)</b>	
Feedback and the Grounded-Grid Amplifier .....	46
Universal Speaker for the Service Bench .....	49
Hi-Fi Comes to the Music Lover (Cover Feature) .....	50
Eggshell Diaphragm Increases H.F. Response .....	51
Tape Recording, Part III .....	52
<b>Servicing—Test Instruments (Pages 55-74)</b>	
Short Circuits .....	55
Peter and the Pilot Light .....	70
Alignment of Gated-Beam Discriminators .....	72
Audio VT Voltmeter for Sensitive Measurements .....	74
<b>Theory and Engineering (Pages 76-82)</b>	
Transmission Lines Simplified .....	76
<b>New Design (Pages 84-93)</b>	
Futuristic Antenna .....	84
New Tubes .....	92
<b>Amateur (Pages 94-100)</b>	
10-Meter Walkie Talkie .....	94
<b>Construction (Pages 102-104)</b>	
DX Crystal Radio Receiver .....	102
<b>Departments</b>	
The Radio Month .....	10
Radio Business .....	14
With the Technician .....	106
New Devices .....	110
New Patents .....	114
Try This One .....	120
Radio-Electronic Circuits .....	124
Question Box .....	128
People .....	132
Technotes .....	134
Miscellany .....	136
Communications .....	138
Electronic Literature .....	142
Book Reviews .....	144

**EXECUTIVE, EDITORIAL and ADVERTISING OFFICES:** 25 West Broadway, New York 7, N. Y. Telephone REctor 2-8630. Hugo Gernsback, President; M. Harvey Gernsback, Vice-President; G. Aliquo, Secretary.

**SUBSCRIPTIONS:** Address correspondence to Radio-Electronics, Subscription Dept., Erie Avenue, P to G Sts., Philadelphia 32, Pa. or 25 West Broadway, New York 7, N. Y. When ordering a change please furnish an address stencil impression from a recent wrapper. Allow one month for change of address.

**SUBSCRIPTION RATES:** In U. S. and Canada, in U. S. possessions, Mexico, South and Central American countries, \$3.50 for one year; \$6.00 for two years; \$8.00 for three years; single copies 30¢. All other foreign countries \$4.50 a year, \$8.00 for two years; \$11.00 for three years.

**BRANCH ADVERTISING OFFICES:** Chicago: 100 E. Ohio St., Tel. Superior 7-1796. Los Angeles: Ralph W. Harker, 1127 Wilshire Blvd., Tel. Madison 6-1271. San Francisco: Ralph W. Harker, 582 Market St., Tel. Garfield 1-2181. **FOREIGN AGENTS:** Great Britain: Atlas Publishing and Distributing Co., Ltd., London E.C.4. Australia: McGill's Agency, Melbourne. France: Brentano's, Paris 2e. Holland: Trilectron, Heemstede. Greece: International Book & News Agency, Athens. So. Africa: Central News Agency, Ltd., Johannesburg; Capetown; Durban, Natal, Universal Book Agency, Johannesburg. Middle East: Stelmatsky Middle East Agency, Jerusalem. India: Broadway News Centre, Dadar, Bombay #14. K. L. Kannappa Mudaliar, Madras 2. Pakistan: Paradise Book Stall, Karachi 3. \*Trademark registered U.S. Patent Office.



**TRAIN for Security! Good-Paying Jobs!**

**MAKE THE MONEY YOU'VE ALWAYS DREAMED OF!**

# LEARN RADIO -TELEVISION

**AND ELECTRONICS  
BY EASY SHOP METHOD  
TRAINING AT HOME!**



**You get all the parts—even tubes!—** for this modern Superheterodyne Receiver. You learn to build it step by step. And you keep it! Get all the facts. Mail coupon now.

Let **NATIONAL SCHOOLS**—a resident-training school for nearly 50 years—train you at home for today's unlimited opportunities in Radio-Television-Electronics. National Schools is one of the largest schools of its kind. It is located in Los Angeles—the center of Radio and TV world! It has four large buildings of modern shops and labs. Its faculty is considered tops in the business.



You learn from lessons prepared by experienced instructors and engineers. Men who are successful Radio and Television technicians. Men who have trained 1000's of men like YOU!



**Only National Schools Gives You This Professional Multi-Tester!**

You get this amazing, new testing instrument—factory-made and tested—complete—ready to use! Simple to operate. Accurate and dependable. An instrument every Radio-TV man needs. Light enough to carry around—so you can use it at home or on service calls. You'll be proud to own this valuable equipment.

**Here are only a Few of the Good-Paying Jobs You Can Choose**

Radio Station Engineer, District Service Manager, Aircraft Radio Inspector, Own Your Own Repair Shop, Inspector Technician, Service Specialist, Special Government Jobs, Complete TV Service, Sound Truck Operator. Many more!

National Schools graduates have secure, good-paying jobs like these! So don't wait—mail the coupon today. Now—while you're thinking about it!

**Attention! Men Going into Service Soon!**

National Schools' course quickly prepares you for many important jobs in the Armed Services. With National Schools Training you have an opportunity to get into special service classifications—with higher pay and grade—immediately!

**FREE SERVICE FOR GRADUATES**

National Schools uses its great influence and prestige to help you find your place in the field of your choice. Don't put it off! Start yourself toward a skilled trade! Get the big pay you've always wanted!

**NATIONAL SCHOOLS**  
LOS ANGELES 37, CALIFORNIA • ESTABLISHED 1905  
In Canada: 193 E. Hastings St., Vancouver, B. C.

**You Train At Home—In Your Spare Time**

National Schools Shop Method Home Training gives you basic and advanced instruction in all phases of Radio-TV-Electronics. And remember—your training is based on resident school training principles. You learn fast from hundreds of diagrams and pictures. All instructions are written by experienced technicians who work in Radio and TV every day. All instructions have been developed and tested in National Schools' own labs and studios, which are equipped with the latest RCA equipment. No wonder this National Schools course is so up-to-date, practical, interesting. And so easy to learn! And no wonder it is held in such high regard by leaders of American industry! Approved for eligible Veterans.

**We Teach You How To Make Welcome Extra Money—While You Learn!**

Many National Schools students—men like you—make plenty of extra dollars each week in spare time! Fixing neighbors' radios, appliances and other ways we teach you. You start learning and earning from the day you enroll. From the very first lesson!

**WE SEND YOU LOTS OF PARTS LIKE THIS!**

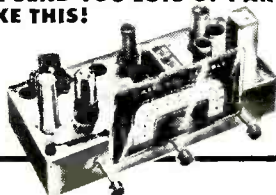

With National Schools Shop Method Home Training, you get basic principles and plenty of practical training. You learn by doing. No wonder you learn so fast! We send you many parts—all of professional, modern quality. You do lots of practical experiments. You advance day by day, step by step. Until you can even build the modern Superheterodyne Receiver you see above—plus other important testing units. The free book tells you all about it. The free sample lesson shows how easy the training is. Use the coupon. Send today—without fail!

**FREE BOOK TELLS YOU HOW!**

Page after page—in color—tells you everything you want to know. Mail the coupon. Get this valuable book today. And if you hurry—YOU GET A FREE SAMPLE LESSON, TOO! Shows how easy National Schools Home Training is. Mail the coupon today.

**Today's Shortage of Trained Technicians Creates Chance of a Lifetime For You!**

Think of it! With guided missiles, radar, and other electronic devices so important to national defense! With big, new developments in TV. With over 90,000,000 home and auto radios, over 12,000,000 TV sets. With more than 3100 radio stations...over 100 TV stations—and more building every day...yes, imagine the great opportunity you have today!

YOU are wanted in Radio-Television-Electronics! America's fastest-growing field. High-pay jobs—the kind you've always wanted—are waiting for YOU!

**Job Security! Big Money! For YOU! in Today's Expanding Industries!**

Trained Radio and Television technicians really make important money these days. Thousands of National Schools graduates—men just like you—are earning good money all over the country. Why not you? And—National Schools graduates get the personal satisfaction of being highly-skilled technicians. Men people respect. Men who enjoy their work—rather than having to drag along in just any old job.

**National Schools Has Trained 1000's of Successful Men! Why Not YOU?**

In almost every state—and many foreign countries—National Schools graduates are filling big jobs with famous companies. Or running their own successful businesses. What are YOU waiting for? National Schools training is complete training. So when you graduate you can take advantage of today's big opportunities in Radio-Television-Electronics—fast.

**DON'T PUT IT OFF! GET THE BIG SALARY YOU HAVE ALWAYS WANTED!**

**MAIL THIS COUPON TODAY—WITHOUT FAIL!**

NATIONAL SCHOOLS, Dept. RG-102  
4000 South Figueroa Street  
Los Angeles 37, California

Mail in envelope or paste on penny post card.

Mail me FREE the book mentioned in this ad. Also a free sample lesson. I understand no salesman will call on me.

NAME \_\_\_\_\_ AGE \_\_\_\_\_

ADDRESS \_\_\_\_\_

CITY \_\_\_\_\_ ZONE \_\_\_\_\_ STATE \_\_\_\_\_

Check here if you were released from the Service less than 4 years ago.

# Same wires— many more voices

Connecting new multi-voice system to open-wire lines, near Albany, Georgia. With new system, 150,000 miles of short open-wire telephone lines can be made to carry up to 16 simultaneous messages economically.



MUCH of your Long Distance telephone system works through cable but open-wire lines are still the most economical in many places. Thousands of these circuits are so short that little would be saved by using elaborate carrier telephone systems which are better suited for long-haul routes. But a new carrier system... the Type O designed especially for short hauls... is changing the picture. It is economical on lines as short as 15 miles. With Type O thousands of lines will carry as many as 16 conversations apiece.

Type O is a happy combination of many elements, some new, some used in new ways. As a result, terminal equipment takes up one-eighth as much space as before. Little service work is required on location; entire apparatus units can be removed and replaced as easily as vacuum tubes.

Moreover, the new carrier system saves copper by multiplying the usefulness of existing lines. For telephone users it means more service... while the cost stays low.

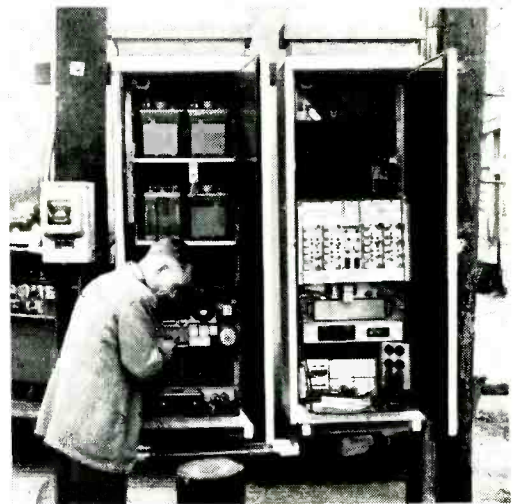

Repeater equipment is mounted at base of pole in cabinet at right, in easy-to-service position. Left-hand cabinet houses emergency power supply. System employs twin-channel technique, transmitting two channels on a single carrier by using upper and lower sidebands. A single oscillator serves two channels.

## BELL TELEPHONE LABORATORIES

Improving telephone service for America provides careers for creative men in scientific and technical fields



RADIO-ELECTRONICS



What you can do now  
to speed your

# SUCCESS IN RADIO- TELEVISION- ELECTRONICS

Send for this FREE CREI Booklet and see

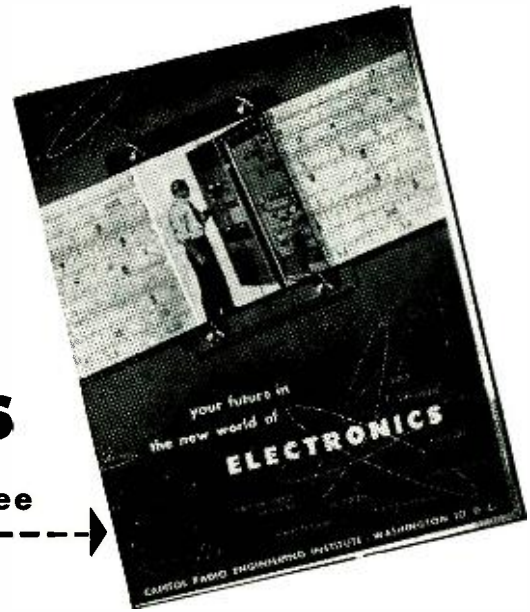

**T**HERE IS A vacancy coming up. It means a boost in pay, prestige and security. Can you fill it? The answer is "No," if you postpone your preparation for success.

The answer is "Yes," if opportunity finds you ready. "Ready" means "TRAINED." And your training must start now, if you expect to be big enough for a bigger job. You ask "What can I do *now*?" You will find many valuable suggestions in a free booklet, "Your Future in the New World of Electronics." Not only does it picture fabulous opportunities . . . it tells you what to do to grow with an industry desperately seeking trained men. Expansion is phenomenal: In the defense build-up alone, many billions in electronics contracts have been awarded. In 1951, the top manufacturers alone sold about \$3 billion in equipment. It is estimated that by 1961 the radio-electronics industry will do no less than \$10 billion per year, excluding defense orders.

Growing civilian markets include radio-equipped police cars, fire-equipment, taxis, planes, ships—in increasing numbers. There are industrial radio network installations, medical applications, and countless others. There are 109 TV stations now on the air and 2000 more expected now that the FCC freeze is off. Already it is estimated there are over 13,000,000 TV sets and over 100,000,000 radios in operation. How these figures will increase in the next few years, the most daring experts are reluctant to predict. This much is certain: Limitless numbers of positions must be filled—in development, research, design, production, testing, inspection, manufacture, broadcasting, telecasting, and servicing. To fill these posts, trained men are needed—men who somewhere along the line are alert enough to improve their knowledge and skills. "Your Future in the New World of Electronics" shows how CREI Home Study leads to greater earnings, by helping get you ready for the openings described above.

CREI promises no short cuts. In an accredited technical school such as this, *you must study* to transform your ambition and energy into knowledge that pays off. Since its founding in 1927, CREI has provided thousands of pro-

fessional radio men with technical educations. During World War II CREI trained thousands more for the Armed Services. Leading firms choose CREI courses for group training in electronics at company expense; among them are United Air Lines, Canadian Broadcasting Corporation, Trans Canada Airlines, Bendix Products Division, All American Cables and Radio, Inc., RCA Victor Division, Mochlett Laboratories, Canadian Marconi and Heppner Mfg. CREI's practical courses are prepared by recognized experts. You get up-to-date material; your work is under the personal supervision of a CREI staff instructor, who knows and teaches you what industry needs. Training is accomplished on your own time, during hours chosen by you. As a graduate, you will find your CREI diploma the key to success in Radio, TV and Electronics. At your service is the CREI Placement Bureau, which finds positions for advanced students and graduates. Although CREI does not guarantee jobs, requests for personnel far exceed current supply. CREI alumni hold top positions in America's leading firms.

Now is the time to decide—to act. When opportunity knocks, knowledge

must be "at home." You supply the willingness to learn. We supply the technical training. This combination of ambition and knowledge is unbeatable in the new Age of Electronics. Fill out the coupon and mail it now. We'll promptly send you your free copy of "Your Future in the New World of Electronics."

CREI resident instruction (day or night) is offered in Washington, D. C. New classes start once a month.

VETERANS: If you were discharged after June 27, 1950—check the coupon for full information about the new G.I. Bill of Rights.

**MAIL COUPON FOR FREE BOOKLET**

**CAPITOL RADIO ENGINEERING INSTITUTE**  
Dept. 1410D, 3224 16th St. N.W., Washington 10, D. C.

Send booklet "Your Future in the New World of Electronics" and course outline.

CHECK	}	<input type="checkbox"/> TV, FM & Advanced AM Servicing	<input type="checkbox"/> Aeronautical Radio Engineering
FIELD OF		<input type="checkbox"/> Practical Television Engineering	
GREATEST		<input type="checkbox"/> Broadcast Radio Engineering (AM, FM, TV)	
INTEREST		<input type="checkbox"/> Practical Radio Engineering	

Name.....  
Street.....  
City.....Zone.....State.....  
Check  Residence School  Veteran

Model 1203D



**HIGH-FIDELITY REPRODUCTION  
AT ONE-TENTH THE COST!**

Model 1201D



**Compared with speakers ten times more expensive—many listeners actually prefer G-E Model 1201D**

**I**N recent tests, many un-biased listeners actually preferred the G-E 1201D for its exceptionally fine reproduction! Side by side comparisons at a given volume level were made to try and determine the difference between these G-E speakers and others costing ten times as much.

These General Electric speakers are designed to meet and surpass the exacting standards of performance so essential to high fidelity. Their wide acceptance spells out the answer—for dependability, durability, and all-round superb performance.

Remember, there's a General Electric speaker for every application—27 speaker models in 8 different sizes!

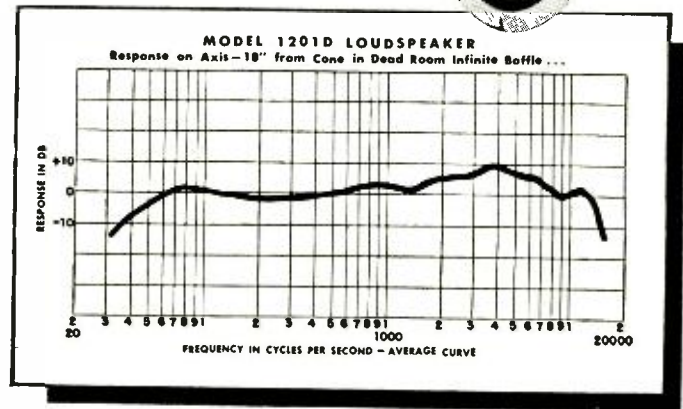

**OUTSTANDING FEATURES:**

- **ECONOMY**—Compare their cost, and you'll find it lower by far than any speaker of comparable quality on the market.
- **EXCEPTIONALLY WIDE FREQUENCY RANGE**—50 to 13,000 cycles.
- **FAMOUS G-E ALUMINUM BASE VOICE COIL**—Unaffected by moisture and temperature variations.
- **G-E ALNICO 5 MAGNET**—for both maximum efficiency and sensitivity.

**GENERAL  ELECTRIC**

**GET THIS  
CATALOG  
FREE!**



General Electric Company, Section 45102  
Electronics Park, Syracuse, New York

Please send me your G-E Loudspeaker Catalog.

NAME \_\_\_\_\_

ADDRESS \_\_\_\_\_

CITY \_\_\_\_\_ STATE \_\_\_\_\_



Prepare Now... in spare time at Home ... for a New,

**PROFITABLE, INTERESTING FUTURE**

# TELEVISION RADIO - ELECTRONICS

RADIO CHIEF OF ILE DE FRANCE  
FRENCH LUXURY LINER PRAISES D. T. I.

Radio Chief—Jean Desmas Says:

"DeForest's Training, Inc., of Chicago, is known not only throughout Europe, but also in many parts of the world as one of America's finest Television, Radio and Electronics training centers."



## JACK DEMPSEY

Former World's Heavyweight Champion

TELLS WHY HE'S PROUD

TO BE WITH **D.T. I.**

- I have been greatly impressed with D.T.I.'s wonderful spirit of friendliness and sincere determination to help its students make good in Television-Radio-Electronics.
- I admire its remarkable 20 year record of helping men build brighter futures.
- I also admire the business policy of its management and the thoroughness of its large faculty of instructors.
- Never have I heard young men praise a school as enthusiastically as do the students and graduates of D.T.I. They are its best boosters.



### Prepare At Home Or In Our Chicago Laboratory!

See for yourself how readily you may prepare at home, or in our modern Chicago laboratories, for a better job or business of your own in one of America's fastest-growing fields—TELEVISION-RADIO-ELECTRONICS.

If you train at home you get (1) the use of a 16-mm. movie projector and 16 reels of animated movies to help you learn important points faster... easier, (2) modern lessons and (3) sixteen shipments of electronic parts enabling you to get valuable practical experience from over 300 projects—including building and keeping the electronic equipment shown below. And upon completing training, you have the optional privilege of building and keeping a big 17-INCH TV set at moderate added cost. Get the full story. Mail coupon today!

### LAUD D. T. I.'s HOME MOVIES IN CONGRESS

D.T.I.'s remarkable home training benefit of visual training MOVIES has been praised from the floor of the House of Representatives in Washington, D. C. and recorded in The Congressional Record.

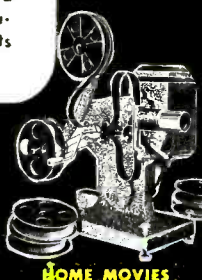

HOME MOVIES



MULTIMETER

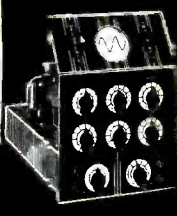

OSCILLOSCOPE

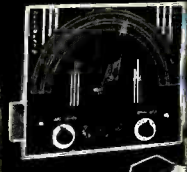

R-F SIGNAL GENERATOR

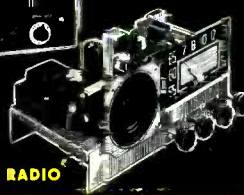

6-TUBE RADIO

**MILITARY SERVICE!**

If subject to military service, the information we have for you should prove very helpful. Mail coupon today.



**De FOREST'S TRAINING, INC.**  
AFFILIATED WITH  
**De VRY Technical INSTITUTE**  
CHICAGO 14, ILLINOIS



### MAIL COUPON TODAY!

Dep. RE-10-1  
**DE FOREST'S TRAINING, INC.**  
2533 N. Ashland Ave., Chicago 14, Ill

I would like your Opportunity News Bulletin showing "89 Ways to Earn Money in Television-Radio-Electronics"; also, the folder showing how I may prepare to get started in this thrilling field.

Name \_\_\_\_\_ Age \_\_\_\_\_

Address \_\_\_\_\_ Apt. \_\_\_\_\_

City \_\_\_\_\_ Zone \_\_\_\_\_ State \_\_\_\_\_





Tung-Sol "Quality Control" recognizes but one standard. All Tung-Sol Tubes meet the highest original equipment requirements of leading radio and tv set manufacturers! Use Reliable Tung-Sol Tubes.

TUNG-SOL ELECTRIC INC.  
Newark 4, N. J.

Sales Offices: Atlanta • Chicago • Culver City  
Dallas • Denver • Detroit • Newark

#### TUNG-SOL MAKES:

All-Glass Sealed Beam Lamps, Miniature Lamps, Signal Flashers, Picture Tubes, Radio, TV and Special Purpose Electron Tubes.



## TUNG-SOL®

RADIO, TV TUBES, DIAL LAMPS



Here's a real lively "stopper" to attract attention to your place of business and emphasize the quality of your service. Colorful—bright red and two shades of blue. 15 inches high. Your jobber salesman will tell you how to get one.

### HUGE COMPUTER "WORRIES"

about giving correct answers. Navy's "Raydac" (Raytheon Digital Automatic Computer), which analyzes performance of guided missiles, has special circuits to bother it if anything goes wrong.

Once a missile is launched, miniature transmitters inside send detailed data concerning its operation so rapidly and in such volume that it is necessary to store this information on high-speed tape recorders. Four magnetic tapes



comprise the Raydac's external memory, store 2,800,000 decimal digits of information for use in computations. The machine's internal memory stores information in the form of ultrasonic pulses in mercury delay-line columns. The pulses circulate within the delay lines 200,000 times per minute, until they are called out to be used in a mathematical calculation. A typical numerical problem proceeds at approximately 1,600 operations per second.

The computer is self-sequenced, i.e. the conclusion of one operation initiates the next.

A check pulse indicating correct operation must be delivered to the sequencing circuits before computation may proceed. When any error occurs, the "worry" circuits halt the computation, and indicate the location of the trouble. However, all work done up to that point is preserved, so that the machine can continue where it left off.

### FIRST-CLASS OPERATORS

would be dropped by 10-kw and smaller broadcast stations under a change in FCC rules proposed by the National Association of Radio and Television Broadcasters. Claiming that routine station operation can be performed by lower-grade licensees, industry spokesmen state that the reduction in operating costs would enable these stations (which represent 95% of the country's 3,000 AM and FM broadcasters) to improve their program services. A first-class operator would still have to be called in for certain operating adjustments.

### MICROWAVE RADIATION

accompanies flares on the sun and sudden blackouts of shortwave radio signals, it now appears. Dr. John P. Hagen and Nanniellou Hepburn of the Naval Research Laboratory report that five bursts of radiation at a frequency of 35,000 megacycles were recorded from May 1 to Oct. 1 last year. Four of the bursts coincided with observed flares and sudden ionic disturbances.

This is the highest frequency at which radio astronomers have recorded tremendous increases in solar radiation.

These bursts usually coincide with those on lower frequencies, but end much sooner and have much smaller amplitude.

Previous work with a highly directive beam had shown that the intensity of the sun's radiation at 35,000 mc was much more constant than at lower frequencies. With improved equipment capable of detecting sudden changes in the intensity of the radiation anywhere on the sun's surface none of the bursts lasted more than five minutes.

### THE AUDIO FAIR, 1952

, slated to open in New York City October 29 at the Hotel New Yorker, will run for four days instead of three as in previous years, closing November 1. Decision to extend the Fair's length was motivated by last year's capacity attendance, together with the belief that this year's attendance will be considerably greater. Theme of the 1952 Fair will be *Audio Today and Tomorrow*. Old-time gooseneck speakers, quarter-pound magnetic pickups, and cylinder-type records will highlight demonstrations of the latest speakers, amplifiers virtually without distortion, binaural tape recordings, and modern LP recordings and pickups which approach the ultimate in sound reproduction.

In addition to American and Canadian manufacturers, participants in the 1952 Fair will include a sizeable group of European companies, and will represent the greatest number of manufacturers of high-fidelity sound equipment ever to participate in a single exhibit. Held annually in conjunction with the convention of the Audio Engineering Society, the Audio Fair has achieved worldwide prominence as a scientific forum. Admission is free to all persons with an interest in the reproduction of sound, hobbyists and professionals alike.

### GERMAN RADIO-TV EXHIBIT

which was to take place in Düsseldorf from August 22nd to 31st, will now be held from February 27th to March 8th, 1953. The Exhibition has been postponed to this date to coincide with the start of regular television programs throughout Western Germany. Transmission is on the 625-line, 50-frame CCIR standard used by all central European countries except France. The standard picture size is expected to be 12 inches, but there will be some 16-inch and projection models. Many of the



Get This Valuable Book  
**FREE**

Just for Examining COYNE'S NEW  
 "1952 EDITION 6-VOLUME SET"  
*Applied Practical Radio-Television*  
 ON 7-DAY FREE TRIAL!

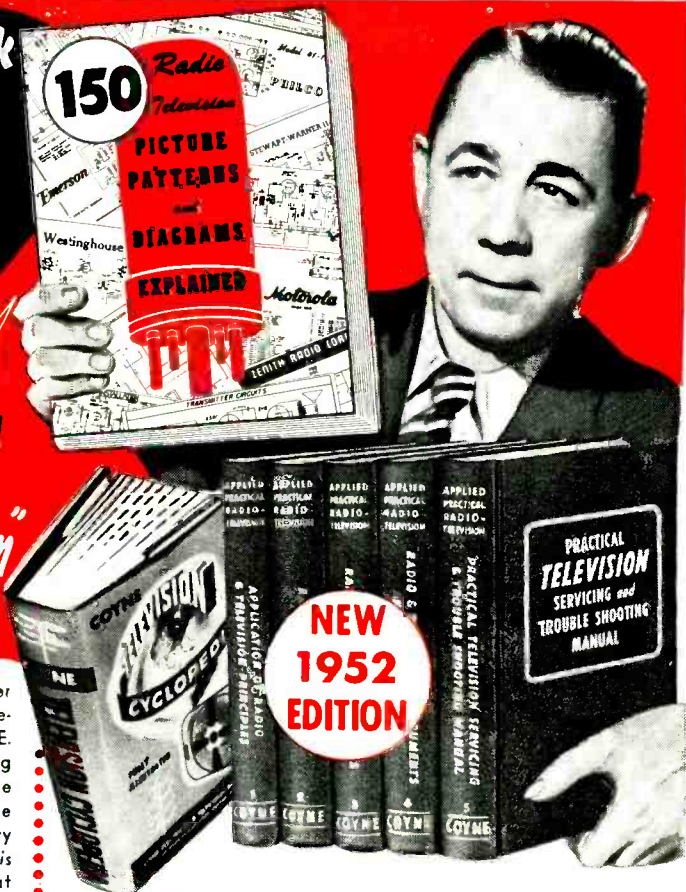

Now! Coyne offers you the most liberal "get-acquainted" offer ever made! Think of it—you get this big, brand new book, "150 Radio-Television Picture Patterns and Diagrams Explained," ABSOLUTELY FREE. Up-to-minute . . . practical . . . valuable. Gives you complete wiring circuits and diagrams on the leading Radio and Television Sets. Large 8½ x 11" pages. Full instructions show you how to read and use the diagrams. One of the most valuable "tools" that belongs in every Radio and Television serviceman's repair kit. *This valuable book is Coyne's FREE GIFT to you!* It's yours for just asking to see the great new Coyne 6-book set, "Applied Practical Radio-Television"!

**HERE'S "KNOW-HOW" THAT MAKES YOU WORTH MORE!**

You'll get into the big money faster in TELEVISION-RADIO if you know where to find the right answers to today's servicing problems—and find them quickly. Coyne's great new 1952 Edition 6-volume set gives you all the answers you want—as fast as you want them! Over 5,000 practical facts and data are fully covered in easy-to-understand fashion in volumes 1 through 5. Every step is completely explained—from principles of radio and television to installing, servicing, trouble-shooting and aligning. So up-to-date, you also get full facts on COLOR TV and UHF, adapters and converters. Hundreds of photos, illustrations, charts and diagrams help you understand quicker. And then, for speedy on-the-job use you also get the famous 762 page Coyne TELEVISION SERVICING CYCLOPEDIA—covering all of today's television problems from A to Z, in easy-to-find alphabetical order. This complete 6 volume TV-RADIO LIBRARY is yours to use FREE for 7 days. And you get the valuable Picture Pattern-Diagram Book ABSOLUTELY FREE for doing so!

**A WORD OF PRACTICAL RADIO AND TELEVISION FACTS AT YOUR FINGER TIPS!**

- Vol. 1. APPLICATION OF TELEVISION—RADIO PRINCIPLES:** 300 pages, covers resonance & tuning, amplifiers, oscillators, etc.
- Vol. 2. RADIO, TELEVISION & FM RECEIVERS:** 403 pages, covers rectifiers, high frequency, short wave, FM, antennas, etc.
- Vol. 3. RADIO-TELEVISION CIRCUITS:** 336 pages, covers power tubes, de-coupling, distortion, photo-tubes, phase inverters, etc.
- Vol. 4. RADIO-TELEVISION INSTRUMENTS & TESTING METHODS:** 343 pages, covers all types of testing instruments, their use in service work.
- Vol. 5. TELEVISION SERVICING & TROUBLE SHOOTING MANUAL:** 400 pages, practical servicing all types of TV sets, UHF, Boosters, color TV printed in 4 colors, etc.

**★ PLUS TV CYCLOPEDIA!**

A "must" for the TV serviceman. Quick answer to all TV problems in A-B-C order, cross-indexed. 762 pages, fully illustrated; covers hundreds of facts on servicing, installation, alignment, UHF, much more.

**ACT NOW—SEND NO MONEY!**

Just mail the coupon for Coyne's 6-volume set on 7 days free trial. We'll include the book of 150 TV-RADIO Patterns & Diagrams. If you keep the set, pay \$3 in 7 days and \$3 per month until \$22.50 plus postage is paid. (Cash price, \$20.95). Or you can return the library at our expense in 7 days and owe nothing. YOU BE THE JUDGE. Either way, the book of TV-Radio Patterns is yours FREE to keep! But this amazing "Get-Acquainted" offer is limited. Act NOW . . . Mail Coupon AT ONCE!

**FREE BOOK—FREE TRIAL COUPON!**

COYNE ELECTRICAL & TELEVISION-RADIO SCHOOL, Dept. A2-T1  
 500 S. Paulina St., Chicago 12, Ill.

YES! Send NEW, 1952 Edition 6-book set, "Applied Practical Radio-Television" for 7 days FREE TRIAL per your offer. Include TV-RADIO Patterns & Diagrams Book FREE!

Name \_\_\_\_\_ Age \_\_\_\_\_  
 Address \_\_\_\_\_  
 City \_\_\_\_\_  
 Where Employed \_\_\_\_\_ Zone \_\_\_\_\_ State \_\_\_\_\_

Check here if you want library sent C.O.D. You pay postman \$20.95 plus C.O.D. postage on delivery. 7-day Money Back Guarantee.

**COYNE** ELECTRICAL & TELEVISION — RADIO SCHOOL  
 500 South Paulina Street  
 Dept. A2-T1, Chicago 12, Illinois

# MERIT

## tv full-line\*

## components give

## universal coverage



**NEW IMPROVED HVO-7 FOR GREATER COVERAGE**  
Tapped AFC Winding. Covers Admiral Chassis 21-24 Series.

**MWC-1 UNIVERSAL WIDTH COIL**  
(3-27 MH) A Tapped Secondary For AGC or AFC.



**IF-RF COILS**  
Only complete line of TV replacements.



**"COSINE" YOKES**  
Complete with leads & network.

MATCHED FOR DIRECT DRIVE



**MDF-30 HVD-8**  
A-3080 Vert. Mtg.  
A-3081 Horiz. Mtg.  
Autoformer



**KIT NO. 1000**  
MATCHED SET FOR SPEEDY  
PROFITABLE SERVICE!

**MERIT . . . HQ for PRACTICAL TV Service Aids**

MERIT'S 1952 Catalog No. 5211 with new MERIT IF-RF Coils.

Other MERIT service aids:

TV Repl Guide No. 404, 3500 models & chassis.

Cross Ref Data, IF-RF Coils, Form No. 14.

See your Jobber or write: Merit Coil and Transformer Corp., 4425 Clark Street, Chicago 40.



These three MERIT extras help you:  
Exclusive: Tapemarked with specs and hook-up data.  
Full technical data packed with every item.  
Listed in Howard Sams Photo-facts.



\*Merit is meeting the TV improvement, replacement and conversion demand with a line as complete as our advance information warrants!

television receivers will also be equipped for FM reception in the 88-108-mc band. Advance announcements by manufacturers indicate a large showing of tape and wire recorders.

**FREE LOOK AT PROGRAM** gives the customers of coin-operated TV sets a chance to save their money. The new *Preview* receiver operates without charge for a few minutes at the beginning of a program; then turns itself off and lights a sign inviting the user to deposit a coin to see the rest. Large blocks of motels have contracted for installation of this new TV entertainment device.

Transvision, Inc., New Rochelle, N. Y., developed the extra-rugged chassis needed for trouble-free operation at the hands of itinerant operators; and has been appointed exclusive manufacturer to supply the set for the *Preview* Corporation.

**AN "ELECTRONIC COP"**, a simple radar-like device that sends out a beam of tiny radio waves and picks up their echoes from moving objects, is being



used to detect automobiles, as well as pedestrians, approaching the main entrance of the General Electric Research Laboratory at Schenectady, N. Y.

The system sends out radio waves only five inches in length which behave much like light waves. They are focused into a beam by an 18-inch parabolic aluminum reflector placed behind one of the windows of the gatehouse.

Some of these waves may be echoed back to the transmitter by an object in the beam. If the object is stationary nothing happens, but if it is moving the returning waves successively go in and out of phase with those being sent out, causing the alarm to operate.

The device has proved especially useful at night and over week ends, when there is little traffic, since security guards are relieved of the need for constantly watching the road. Approach of a car rings a bell, warning a guard whose attention may have been temporarily diverted, as by a telephone call.

A person walking is detected at about 100 feet; an automobile produces an

effect while several hundred feet away. The flat end of a metal-body trailer truck is effective at a considerably greater distance.

**TITANIUM-DIOXIDE RECTIFIERS**, developed by R. G. Breckenridge and W. R. Hosler, are now under study at the National Bureau of Standards. The new elements resemble copper oxide rectifiers physically, but show markedly different electrical characteristics. Conduction is reversed, and performance actually improves with increasing temperature, up to about 150 degrees C.

**TELEVISION IN URUGUAY** will be delayed until financial problems have been cleared. Although a loan by the Banco de la Republica has been authorized to establish a station in Montevideo, the capital city, foreign exchange difficulties, involving half a million dollars needed to purchase equipment abroad, are responsible for the postponement. When funds are finally made available, it is expected that equipment deliveries will take six months, and the installation and preliminary testing three additional months.

**CLOSED-CIRCUIT TV** for railroads is proving ideal for yard watching operations and equipment checks. An RCA Vidicon installation for the Baltimore and Ohio R.R. flashes incoming freight-car numbers to the control tower, while another unit inspects passing cars for damaged riding gear. The New Haven Road will check cars for hotboxes with 14 Du Mont units.

Prices of industrial TV systems now range from \$4,200 for Diamond Power Specialty Corp.'s Utiliscope, used by power companies for checking furnace and chimney operation, to \$25,000 for CBS-Remington Vericolor. Large department stores use Vericolor units at eye-catching points, for showing fashions, furnishings, and bargain specials. RCA's railroad unit costs \$5,500.

**FCC MAY ADD 540 KC** to present broadcast band. A proposed amendment to present regulations would open the extra channel for Class II (experimental) operation. The National Association of Radio and Television Broadcasters is backing the Commission's proposal.

**U. S. TV SERVES CANADIAN** firefighters. Burnaby, B. C., firemen got their first news of a recent \$500,000 three-alarm warehouse blaze five miles from the firehouse on their television receiver. The set was tuned to a station in Seattle, Washington, 150 miles away.

**EARL C. RAYNER**, founder of one of the earliest radio publications of the broadcast period, died on August 17 at the age of 63. He founded the magazine *Radio Digest*, which in the early '20's catered to the broadcast listener and experimenter. Old-timers will remember the magazine as the one that introduced the Solodyne circuit to American experimenters. **END**



# HERE'S PROOF!

Glass used  
in second hand  
tubes is  
**20% DIMMER**  
than **NEW**  
**GLASS** used in



**RAYTHEON**

## PICTURE TUBES

**T**HE unretouched picture above demonstrates why you risk your reputation as a competent service dealer every time you sell your customers a second hand tube.

A standard Raytheon Tube was put on life test equipment and adjusted so that the raster did not cover the entire face of the tube. The tube was given the equivalent of 1000 hours of operation in a consumer set. The tube neck was then cut, the gun removed, the tube renecked and the screen washed out. The bulb was re-washed and rescreened and as you can see, the portion of the bulb that was scanned is about 20% darker than the unscanned area. In short,

scanning darkens glass and any used bulb that is rescreened will be 20% darker than a new bulb. The only way you can get new tube-brightness out of a second hand tube, is to increase the beam current. And since beam current comes from the cathode, increasing the beam current shortens tube life. For this reason, when you replace with second hand tubes your customer loses, and in the long run so do you!

It's good business to always replace with *new* tubes. And, of course, if you want the finest new tubes that money can buy...



**RAYTHEON**

... use **RAYTHEON TELEVISION PICTURE TUBES** ♦  
They're Right for Sight ... and Right for You ... and Always New!

**RAYTHEON MANUFACTURING COMPANY**

Receiving Tube Division

Newton, Mass., Chicago, Ill., Atlanta, Ga., Los Angeles, Calif.

RAYTHEON MAKES ALL THESE:

*Excellence in Electronics*

RECEIVING AND PICTURE TUBES • RELIABLE COMMERCIAL AND INDUSTRIAL TUBES • SERVO MOTOR TUBES AND SUBSTITUTES • ELECTRONIC TUBES • RECTIFIER TUBES

**NEW VOL. 4 JUST OUT!**  
**Sams' "AUTOMATIC RECORD CHANGER SERVICE MANUAL"**



**You'll want it for your Service Data Library**  
 NEW—full electrical and mechanical data on 38 record changers, wire and tape recorders made during 1951. Features exclusive "exploded" view diagrams, "all-view" photos, full change cycle data, adjustments, service hints and kinks, complete replacement parts lists. Shows methods used for record support, record selection, pickup arm handling, needle setdown point determination, tripping, etc. Full head-adjustment, cleaning, lubrication and operation details on each wire and tape mechanism. Authoritative, accurate data based on lab analysis of the actual equipment. Makes you an expert on changer and recorder repairs. 288 pages, 8½ x 11". ORDER **CM-4**. Only..... \$3.00

**VOL. 3.** Covers 44 changers and recorders made in 1949 and 1950. ORDER **CM-3**. Only..... \$3.00  
**VOL. 2.** Covers 45 changers and recorders, 1948 and early 1949. ORDER **CM-2**. Only..... \$4.95  
**VOL. 1.** Covers 41 post-war changers and recorders made up to 1948. ORDER **CM-1**. Only..... \$3.95  
**ORDER THE COMPLETE "CHANGER LIBRARY!"**

**BEST-SELLERS ON "AUDIO"**

**"Audio Amplifier Service Data Manuals"**  
**VOL. 3.** Full detailed analysis of 50 important audio amplifiers and 22 FM and AM tuners produced during 1950. Uniform, complete coverage based on lab analysis of the actual equipment. Provides everything you need to know to service or understand each unit. Never before available in a single compilation. 352 pages, 8½ x 11". ORDER **AA-3**. Only..... \$3.95  
**VOL. 2.** Covers 104 amplifiers and 12 tuners produced in 1949. 368 pages. ORDER **AA-2**. Only..... \$3.95  
**VOL. 1.** Covers 102 post-war amplifiers and tuners produced through 1948. 352 pages. ORDER **AA-1**. Only..... \$3.95

**"The Recording & Reproduction of Sound"**  
 Only complete reference on AUDIO! New second edition—over 800 pages. Chapters on sound wave behavior; recording methods; the decibel; phono reproducers; cutting styli; microphones; loudspeakers; dividing networks; attenuators; mixers; amplifiers; tuners; home music systems—hundreds of other subjects. The great Audio book by Oliver Read—largest-selling in its field. ORDER **RR-1**. Only \$7.95

**HOWARD W. SAMS & CO., INC.**

Order from your Parts Jobber today, or write direct to Howard W. Sams & Co., Inc., 2205 East 46th St., Indianapolis 5, Ind.

\$. . . . . enclosed. Send following books:  
 CM-4    CM-3    CM-2    CM-1  
 AA-3    AA-2    AA-1    RR-1

Name.....  
 Address.....  
 City.....Zone.....State.....



**BAROMETER of the PARTS INDUSTRY**

During August, 42 of the leading 400 manufacturers of Radio-Television-Electronic parts and equipment made changes in their lines. Actually there was an increase in "change activity" as compared to July.

In price revisions by the number of manufacturers and products affected, the following summary illustrates the comparative trend for the months of July and August.

	No. of Manufacturers	
	July	August
Increased prices	4	5
Decreased prices	17	14

	No. of Products	
	July	August
Increased prices	7	9
Decreased prices	88	515

For a summary of the most active product categories, see the following table:

Product Group	Increased Prices		Decreased Prices		New Products		Discontinued Items	
	No. of Mfrs.	No. of Products	No. of Mfrs.	No. of Products	No. of Mfrs.	No. of Products	No. of Mfrs.	No. of Products
Antennas & Access.	1	1*	3	37*	5	32**	2	26*
Capacitors	0	0	1	300*	1	49*	1	3*
Controls & Resistors	0	0	0	0	0	0**	1	32**
Sound & Audio Prod.	0	0	2	16*	8	49**	3	18*
Test Equipment	2	3*	1	1*	4	10**	1	1**
Transformers	0	0	1	11*	4	62**	2	8*
Tubes	1	3**	5	49*	5	58*	3	42*
Wire & Cable	1	2	1	101	0	0	0	0

\* Increase over July  
 \*\* Decrease from July

**Comment:** As previously noted, product activity in the Electronic Industry continues to center upon the introduction of new items. At the same time manufacturers are withdrawing products at almost the same pace. Price increases and decreases are quite spotty with no apparent trend at this time.

This data is prepared by the staff of United Catalog Publishers, Inc., 110 Lafayette Street, New York, publishers of RADIO'S MASTER, the Official Buying Guide of the Parts Industry.

**Merchandising and Promotion**

The RCA Victor Tube Department launched a point-of-sale promotion cam-



New RCA stylus-replacement bonus kit.

paign to promote the use of RCA replacement crystal cartridges and styli. The campaign is built around a new crystal cartridge package, a bonus offer of a styli utility cabinet and a universal stylus wrench with each model inventory of styli ordered by a dealer.

Sprague Products Co., North Adams, Mass., is issuing a new window display poster, "Why Doesn't My Set Stay Fixed?" which gives a clear answer to this frequently asked customer query. The poster is signed by Harry Kalker, president of Sprague Products. It is available, free, from distributors, or for ten cents, to cover handling, from the company.

The Walter L. Schott Co., Los Angeles, will celebrate the production of its 1,500,000th TV antenna by awarding four free vacation certificates. Two all-expense vacations will be given to the distributor who sells the lucky antenna and two to the service technician who buys it. The winners may select any



Walter L. Schott (left) with antenna featured in new Walsco prize contest.

vacation spot in America for a full week. Transportation will be supplied aboard a TWA Super Constellation.

Merit Coil & Transformer Corp., Chicago, held a series of combined jobber and TV service technician's conferences in St. Louis and Omaha. They were addressed by Chet Jur, chief TV technical engineer. The St. Louis meeting was sponsored by Radonics, Van Sickle Radio Co., Hollander & Co., and Tom Brown Interstate Supply Co. The Omaha meeting was held under the auspices of the J-B Distributing Co., Omaha Appliance Co., and World Radio Laboratories.



RCA's Television Dynamic Demonstrator was shown recently by John



John Meagher (left) of RCA shows his TV-receiver demonstrator panel.

Meagher of the company's Television Service Clinic at an Electronic Fair, the second annual show of this type sponsored by the Lew Bonn Co., Minneapolis distributors.

Jensen Industries, Chicago, is running a contest for service technicians from September 1 to the end of the year. Cash prizes will be awarded to those



Karl W. Jensen, of Jensen Industries, Inc., announces phono-needle contest.

who send in the most empty Jensen needle packages during this time. \$1,000 is the top award in this *Win a Grand* contest.

Vaco Products Co., Chicago, designed a versatile, new *Vari-Board* for display-

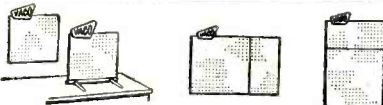
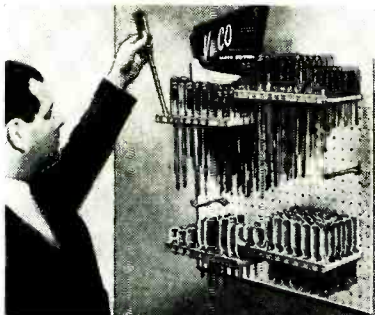

Flexible "Vari-Board" displays Vaco line of hand tools for electronics industry.



You're always right with Sprague's **85°C (185°F)** smaller, versatile and dependable

# ATOMS

You only need to stock one 'lytic tubular for every application when you buy Sprague Atoms . . . whether it be an auto radio set . . . a home radio-phonograph combination . . . or a television receiver. Sprague Atoms are the smallest dependable electrolytics. They're always right size-wise to fit the most crowded chassis. And they're right temperature-wise to fit the hottest TV receiver!

Write for Catalog C-608 to Sprague Products Company, 81 Marshall St., North Adams, Mass.

(Distributors' Division of Sprague Electric Company)

**INSIST ON ATOM® ELECTROLYTICS**

MADE BY



THE WORLD'S LARGEST CAPACITOR MANUFACTURER

**Model 666-R**

*NOTE the wide ranges of this compact pocket-size instrument. Note controls—flush with panel. Then study the inside view. Nowhere will you find, in design and manufacturing quality, the equal of 666-R.*



# A BASIC TOOL

**POCKET-SIZE: VOLT-OHM-MIL-AMMETER  
WITH SELF-CONTAINED RESISTANCE RANGES TO 3 MEGOHMS**

**1. Resistance Ranges** from 0-3000 Ohms (.5 Ohm low reading) to 3 Megohms, self-contained. Also A.C.-D.C. Volts to 5000, 10 ranges; and 3 Direct Current ranges.

**2. Enclosed Selector Switch,** molded construction. Keeps dirt out, and retains contact alignment permanently.

**3. Unit Construction**—Resistors, shunts, rectifier, batteries, are housed in a molded base integral with the switch. Direct connections without cabling. No chance for shorts.

**4. Resistors** are precision film or wire-wound types, each in its own compartment.

**ONLY \$26.50—at your Distributor**

*Prices Subject to Change*

FOR THE MAN WHO TAKES PRIDE IN HIS WORK

# Triplet

TRIPLETT ELECTRICAL INSTRUMENT CO., BLUFFTON, OHIO, U. S. A.



**THE ONLY COMPLETE CATALOG FOR EVERYTHING IN TELEVISION, RADIO AND INDUSTRIAL ELECTRONICS**

**your 1953  
ALLIED free!  
236-PAGE CATALOG  
complete...value-packed**



Here's the *one* authoritative, complete Buying Guide to *Everything in Electronics*—packed with the world's largest selections of quality equipment at lowest, money-saving prices. See the latest in TV, AM and FM receivers; High-Fidelity Custom Sound components; latest P.A. Systems and accessories; recorders; Amateur receivers, transmitters and station gear; specialized industrial electronic equipment; test instruments; builders' kits; huge listings of parts, tubes, tools, books—the world's *most complete stocks* of quality equipment.

ALLIED gives you every buying advantage: speedy delivery, expert personal help, lowest prices, liberal time payment terms, assured satisfaction. Get the latest 1953 ALLIED Catalog. Keep it handy—and save time and money. Send for your FREE copy today!

**the world's largest stocks**

- TV and Radio Parts
- Test Instruments
- Hi-Fi and P.A. Equipment
- Television & Home Radios
- Recorders and Supplies
- Amateur Station Gear
- Builders' Supplies
- Equipment for Industry

**quick, expert service**

**EVERYTHING IN ELECTRONICS**

**ALLIED RADIO**  
World's Largest Radio Supply House



**free**

Send Today for Radio's Leading Buying Guide

**EASY-PAY TERMS**

Take advantage of ALLIED'S liberal Easy Payment Plan—Radio's best terms—only 10% down, 12 months to pay—no interest if you pay in 60 days. Available on Hi-Fi and P.A. units, recorders, TV chassis, test instruments, Amateur gear, etc.

**TV & HI-FI SPECIALISTS**

To keep up with developments in TV and High-Fidelity, look to ALLIED! Count on us for all the latest releases and largest stocks of equipment in these important fields. If it's anything in Television or High-Fidelity equipment—we have it in stock!

ALLIED RADIO CORP., Dept. 2-K-2  
833 W. Jackson Blvd., Chicago 7, Illinois

Send FREE 236-Page 1953 ALLIED Catalog

Name \_\_\_\_\_

Address \_\_\_\_\_

City \_\_\_\_\_ Zone \_\_\_\_\_ State \_\_\_\_\_

# TINY-TRIM and TERRIFIC

## THE TURNER 80

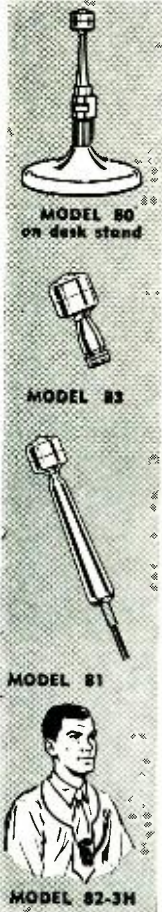

This is the new Turner 80 — a crystal microphone so tiny it hides in the palm of your hand, yet so strikingly designed it is the very picture of scintillating symmetry. Weighs less than five ounces, yet its high output and unusually fine response characteristics make it a natural for announcing and mobile public address systems, for home recording, dictating machines, amateur communications, portable recorders and dozens of other applications. Finished in beautiful satin chrome. Level: Approximately 58 db below 1 volt/dyne/sq. c.m. Response: 80 — 7000 c. p. s. 7 foot attached single conductor shielded cable.

List Price-----\$15.95

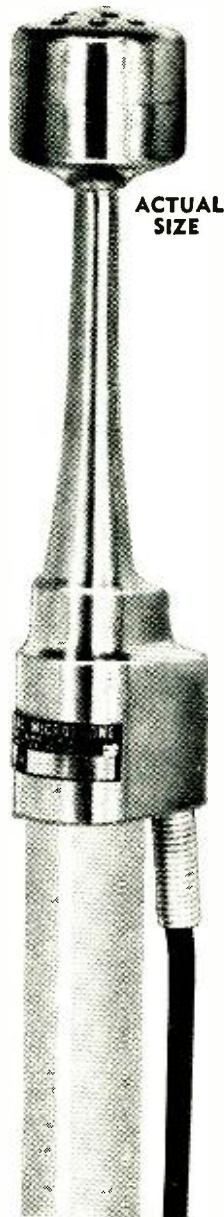

### THE TURNER COMPANY

933 17th St., N. E. Cedar Rapids, Iowa

IN CANADA:

Canadian Marconi Co., Ltd. Toronto, Ont., and Branches

EXPORT:

Ad. Auriemo, Inc.

89 Broad Street, New York 4



Crystals licensed under patents of the Brush Development Company

RADIO-ELECTRONICS is paying good rates on acceptance for original and unusual articles on phonograph, television, FM and AM servicing, as well as articles on industrial electronic equipment and applications. Good constructional stories on receivers or other pieces of electronic equipment can also be used. Send for a copy of our Author's Guide. Address:

THE EDITOR

RADIO-ELECTRONICS

25 West Broadway

New York 7, N. Y.

ing its screwdrivers. The punched-out Masonite construction permits a variety of uses. A specific model has been designed for sales in the electronic field.

M. A. Miller Manufacturing Co., of Chicago, is repackaging its No. 550 and No. 560 needles and is also featuring a new item, the No. 35 straight-shaft needle which is tipped with osmium alloy.

General Electric, Syracuse, N. Y., is planning an intensive nationwide educational program designed to familiarize technicians with its new Strato-power TV chassis.

Insuline Corporation of America, Long Island City, N. Y., released a new eight page brochure describing its facilities for the production of electronic parts and equipment.

The Battery Committee of the National Electronic Distributors Association prepared a new "Sales Booster" in the form of a battery index which is designed to eliminate confusion in the handling of dry batteries and at the same time increase sales. Copies are available from the NEDA office at 221 N. LaSalle St., Chicago.

#### Production and Sales

The RTMA announced that June TV picture-tube and radio receiving-tube sales were above those for May, with totals of 376,943 and 24,365,462, respectively. For the first six months of 1952, a total of 2,393,980 TV picture tubes and 160,183,526 receiving tubes were sold. Both of these figures are off from the 1951 period.

The RTMA reported that 2,118,510 TV sets were shipped to dealers during the first six months of 1952.

#### New Plants and Expansions

Sylvania Electric Products announces that its Electronics Division is now located in new headquarters in Woburn, Mass. The new plant will house the administrative, sales, engineering, and manufacturing staffs of the division, which manufactures electronic products to be used in such fields as radar, navigation, communications, and flight.

Ampex Electric Corp., Redwood City, Calif., opened expanded Midwestern district sales facilities in Chicago under the direction of Russell J. Tinkham. The new location includes sales offices, showrooms, and warehouse facilities.

Skottie Electronics, a new corporation which will manufacture disc plate, tubular ceramic capacitors and other electronic items, was formed in Peckville, Pa. Officers are Joseph P. Sewack, president; Paul Machiesky, secretary; James Mitchell, treasurer and Karl E. Bretz, executive vice president in charge of sales. Mitchell was an executive with Electrical Reactance Corp. and Bretz with the Hi-Q Division of Aerovox.

The Philco Corp. Government and Industrial Division established headquarters at a new address, 4700 Wissahickon Ave., Philadelphia.

Allen B. Du Mont Laboratories announced the formation of Du Mont Television & Electronics, Ltd., Montreal, a Canadian subsidiary which will make



# FREE

TELLS HOW—

## WE GUARANTEE

TO TRAIN YOU AND COACH YOU  
AT HOME UNTIL YOU GET

## YOUR FCC LICENSE

if you have had any practical radio experience—  
amateur, Army, Navy, radio repair, or experimenting



**TELEVISION ENGINEERING** Included in our Training and Coaching

Your FCC Ticket is Recognized in All Radio Fields as Proof of Your Technical Ability

**ACT NOW!**

### TELLS HOW— Our Amazingly Effective JOB-FINDING Service Helps CIRE Students GET BETTER JOBS

#### GETS JOB WITH CAA

"I have had a half dozen or so offers since I mailed some fifty of the two hundred employment applications your school forwarded me. I accepted a position with the Civil Aeronautics Administration as a Maintenance Technician. Thank you very much for the fine cooperation and help your organization has given me in finding a job in the radio field."  
Dale E. Young, 122 Robbins St., Owosso, Mich.

#### GETS CIVIL SERVICE JOB

"I have obtained a position at Wright-Patterson Air Force Base, Dayton, Ohio, as Junior Electronic Equipment Repairman. The Employment Application you prepared for me had a lot to do with my landing this desirable position."  
CHARLES E. LOOMIS,  
4516 Genessee Ave., Dayton 6, Ohio.

#### GETS FIVE JOB-OFFERS FROM BROADCAST STATIONS

"Your 'Chief Engineer's Bulletin' is a grand way of obtaining employment for your graduates who have obtained their 1st class license. Since my name has been on the list I have received calls or letters from five stations, in the southern states, and am now employed as Transmitting Engineer on WMMT."  
ELMER POWELL, Box 274, Sparta, Tenn.

#### GETS PUBLIC UTILITIES JOB

"I have secured the position of Radio Technician with the Toledo Edison Company. I want to thank you once more. The help you gave me was much more than would ordinarily be expected—both in obtaining my license and in finding employment."  
Norman W. Stokes, Jr., Rt. 11, Box 612, Toledo 7, O.

### TELLS HOW— Employers Make JOB OFFERS Like These To Our Graduates Every Month

Telegram from Chief Engineer, Broadcast Station, Pennsylvania: "Immediate opening for engineer. Automobile and First Phone a must. If graduate available, please forward name and address."  
Letter from Chief Engineer, Broadcast Station, Montana: "Immediate opening for Engineer-Announcer. Basic salary \$62.50... real future for

right man!"  
Letter from Chief Engineer, Broadcast Station, Tennessee: "Have opening for operators. If you have men, please have them contact us."  
These are just a few examples of the job offers that come to our office periodically. Some licensed radioham filled-each of these jobs; it might have been you!

#### HERE'S PROOF FCC LICENSES ARE OFTEN SECURED IN A FEW HOURS OF STUDY WITH OUR COACHING AT HOME IN SPARE TIME

Name and Address	License	Lessons
Lee Worthy, 2210 1/2 Wilshire St., Bakersfield, Cal.	2nd Phone	16
Clifford E. Vogt, Box 1016, Dania, Fla.	1st Phone	20
Francis X. Foerch, 38 Beucler Pl., Bergenfield, N. J.	1st Phone	38
S/Sgt. Ben H. Davis, 317 N. Roosevelt, Lebanon, Ill.	1st Phone	28
Francis X. Foerch, 38 Beucler Pl., Bergenfield, N. J.	1st Phone	38

CARL E. SMITH, E.E., Consulting Engineer, President

Ours is the only home study course which supplies FCC-Type Examinations with all lessons and final tests.

### CLEVELAND INSTITUTE OF RADIO ELECTRONICS

Desk R - 92, 4900 Euclid Building, Cleveland 3, Ohio

(Address to desk to avoid delay)

**Mail This Card Now**  
NO POSTAGE REQUIRED

**Get All 3 FREE**

I want to know how I can get my FCC ticket in a minimum of time. Send me your FREE booklet, "How to Pass FCC License Examinations" (does not cover exams for Amateur License), as well as a sample FCC-type exam and the amazing new booklet, "Money-Making FCC License Information".

Tell me about your Television Engineering Course.

NAME \_\_\_\_\_  
ADDRESS \_\_\_\_\_  
CITY \_\_\_\_\_  
ZONE \_\_\_\_\_ STATE \_\_\_\_\_

SEE OUR AD ON NEXT PAGE

# Want To Double Your Pay?



I can train you to pass your FCC License Exams in a minimum of time if you've had any practical radio experience—amateur, Army, Navy, radio servicing, or other. My time-

proven plan can help put you, too, on the road to success. Just fill out the coupon and mail it. I will send you free of charge, a copy of "How To Pass FCC License

Exams," plus a sample FCC-type Exam, and the amazing new booklet, "Money Making FCC License Information."  
EDW. H. GUILFORD, Vice President

## How To Pass **FCC** **COMMERCIAL** **RADIO OPERATOR** **LICENSE** **EXAMINATIONS**



### HERE IS YOUR GUARANTEE

Should you fail the FCC commercial license examinations after completing your course, we guarantee to continue your training, without additional cost of any kind, until you successfully obtain your commercial license, provided you first take your examinations within 90 days after completing the course.

### IMPORTANT

SEE OTHER SIDE FOR MORE INFORMATION

Desk R-92

Cleveland Institute of Radio Electronics

4900 EUCLID AVENUE

CLEVELAND 3, OHIO



**BUSINESS REPLY CARD**  
FIRST CLASS PERMIT No. 8685, Sec. 34.9, P.L. & R. Cleveland, Ohio



TEAR OUT AND MAIL THIS CARD NOW!

### And Here's Proof that CIRE Students Really Do Get Their FCC Licenses

"I was very pleased to receive my diploma for Nilson's Master Course, after which I took the exam for First Class Radiotelephone and the Radar exam. I am happy to say I received my First Class license, number P1-2-4361 with the Ship Radar endorsement. I experienced no difficulty at all in taking these exams, thanks to Nilson's Master Course."

RICHARD E. STREBEL, Box 589, New Providence, N. J.

"I took the license examination for 2nd 'Phone and 2nd Telegraph, in Knoxville, Tenn. I am happy to advise that I passed both in fine shape. I received my licenses this morning. Your course proved invaluable in preparing for the examination."

E. F. JONES, Jr., Gollatin, Tenn.

### HOW OUR AMAZINGLY EFFECTIVE JOB-FINDING SERVICE WORKS FOR YOU

- 1 200 EMPLOYMENT APPLICATIONS  
200 employment applications, with our letter of recommendation attached, addressed to employers of your choice, in areas you select, in broadcasting, mobile communication, manufacturing, airlines, CAA, State Highway Communication, Police Radio, and other fields of radio employment.
- 2 CHIEF ENGINEERS BULLETIN  
Mailed every month to the chief engineers of every AM, FM, and TV broadcast station in the United States and territories. If you want a broadcast technician's or engineer's job this is an amazingly effective way to get your choice of broadcast jobs almost anywhere in the U.S.A.
- 3 "JOB WANTED" LIST  
Mailed to all employers who telegraph, telephone, and write asking for our graduates. We regularly receive requests for our students from almost every state in the Union. No greater tribute can be paid to the high caliber of our training, coaching and Job-Finding Service!



### If You're in the Armed Forces

#### PLAN NOW for PRESENT and FUTURE SECURITY IN CIVILIAN LIFE

- 1 Use your spare time, NOW, while you are in the armed forces, to prepare for the FCC license examinations, and get your FCC Commercial License.
- 2 Shortly before discharge, use our AMAZINGLY EFFECTIVE JOB-FINDING SERVICE to get your choice of good-pay jobs.

#### Ex-Navy Man Gets RCA Job

"Since my discharge from the Navy I have been employed by RCA Service Company. Believe it or not, I owe all of my good fortune to your course of instruction, and I can truthfully recommend it to anyone."

CLARENCE JOHNSON, 730 Barron, Redwood City, Calif.



**Stromberg-Carlson employs Ex-Army Man**  
"I am now working as a lab technician

in the engineering department of Stromberg-Carlson Company. My CIRE course and 2nd 'phone helped a great deal in obtaining this position."

JOHN P. DALEY, P.O. Box 327, Limo, New York

CARL E. SMITH, E.E., Consulting Engineer, President  
**CLEVELAND INSTITUTE OF RADIO ELECTRONICS**  
4900 EUCLID BUILDING • CLEVELAND 3, OHIO  
Desk R-92 (Address to desk No. to avoid delay)



licensing agreements with Canadian manufacturing organizations for the manufacture of Du Mont products in Canada. Dr. Thomas T. Goldsmith, Jr. is president, Ernest A. Marx, vice-president, and Bert L. Graham, secretary-treasurer.

**Business Briefs**

... Raytheon Manufacturing Co., Waltham, Mass., voted to change the name of its television manufacturing subsidiary, Belmont Radio Corp., Chicago, to Raytheon Television & Radio Corp.

... Bulova Watch Co., Inc., New York City, took another step into the electronics field with the introduction of a new clock radio. The company had previously announced a licensing agreement with Western Electric for the development and production of transistors.

... The 1952 Radio Fall Meeting which will be held in the Hotel Syracuse, Syracuse, N. Y., October 20 to 22, under the sponsorship of the RTMA Engineering Department, will feature three technical sessions on television, including u.h.f. and color TV.

... Webster-Chicago Corp. and Radio Electric Service Co., its Pennsylvania distributor, appointed the Witte Radio & Television Co., Philadelphia, as official service station for "Webcor" products.

... Motorola, Inc., Chicago, was awarded a \$28,000,000 contract for two-way communications equipment by the U.S. Signal Corps.

... RCA sold the experimental u.h.f. TV station KC2XAK at Bridgeport, Conn., to the Empire Coil Company of New Rochelle, N. Y., for installation in Portland, Oregon. The station broadcasted programs from WNBT, New York City, on a regular schedule from December 29, 1949, to August 23, 1952.

... NEDA announced that four new members had been admitted to the Association: Joseph F. d'Aquin, Crescent Radio & Supply, Inc., New Orleans; Howard Bristol, Bristol Distributing Co., Fargo, N. D.; Harold Bruce, Harold Bruce Co., Springfield, Ill.; and V. R. Lampley, Lampley Radio Co., Benton, Ill.

... The RTMA announced a new statistical service covering the movement of radio and TV receivers at the retail level, including dealers' sales and inventories. The new plan was proposed by retired president Glen McDaniel and was developed by the RTMA Industry Statistics Committee, under chairman Frank W. Mansfield, Sylvania Electric Products, and RTMA statistical director William F. E. Long.

... There were 18,354,300 TV sets in use in the U.S. as of August 1, according to NBC.

... Standard Coil Products, Chicago, set a list price of \$13.75 per set on u.h.f. tuning strips for its turret tuners. Each set will tune in one u.h.f. channel.

... Both Du Mont and Admiral have announced that they plan to bring out only one new line of receivers a year, beginning in 1953. All service technicians will rise and say Amen. END

# Famous Guns



**Deringer Percussion Pistol, Model 1843**, product of Henry Deringer of Philadelphia. Deringer's large caliber, short barreled pocket pistols were so popular that others imitated them—calling them "derringers". John Wilkes Booth used a Deringer to assassinate Lincoln.



**Trap or Doorjamb Pistol, Caliber .31**, made by North & Couch, Middletown, Conn. This lethal little device protected householders against burglars. Fixed to the doorjamb, with a cord running from muzzle rod to door, the pistol fired all its barrels into any intruder.



**Weller Instant-heating Soldering Gun** for light or heavy work. Dual heat greatly increases tip life. Switch instantly to high or low heat as job requires. Pre-focused spotlights end "blind soldering". Exclusive tip-fastening arrangement assures full, constant heat. High-impact plastic housing. Perfect balance. Low-cost replaceable tips. Pays for itself in a few months. See at your Distributor or write for Bulletin direct.

Get **SOLDERING TIPS**, new Weller Handy Guide to faster, easier soldering. 20 pages fully illustrated. Price 10c at your Distributor or order direct.

**Weller** BETTER FROM GRIP TO TIP!

**SOLDERING GUNS** 828 Packer Street, Easton, Pa.  
The Finest Soldering Tool for the Finest Craftsmen

# **CHANNEL MASTER**

*proudly introduces*

## **the world's first Broad Band Yagi**

*the*  
**f·u·t·u·r·a·m·i·c**

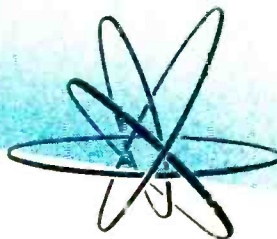

**A great new type of antenna  
that combines:**

-  **Broad Band coverage** *with the*
-  **high gain and directivity of the Yagi**

Spectacular high gain! Razor-sharp directivity! In fact, all the brilliant performance that only a Yagi can deliver, is now yours with the FUTURAMIC — not on just one channel, but CLEAR ACROSS THE BAND!

For the first time in television history, here is an antenna that not only solves today's installation problems — but also provides for the new VHF channels of the future. This is the antenna you have been waiting for — the 10 Element FUTURAMIC is a true Broad Band Yagi!



# the antenna designed for today and tomorrow!

The same **FUTURAMIC** that...

✧ Solves **today's** reception problems

✧ Will also receive **tomorrow's** new VHF channels

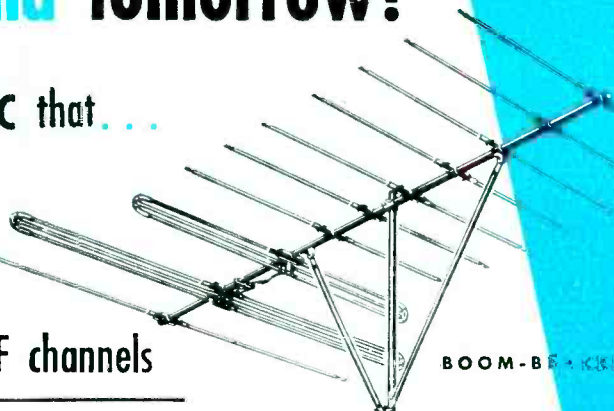

## THE FUTURAMIC MEANS BIG BUSINESS FOR YOU IF YOU SERVE ANY OF THESE 3 BOOMING VHF MARKETS!

### Areas in which the FCC has ordered VHF stations to change channels (on the same band).

When a channel-shift takes place, the thousands of single-channel Yagis in use will become obsolete overnight. The set owner will face a dilemma: If he changes his antenna *before* the channel-shift, he will be without reception until the shift occurs. If he waits until the station changes channels, he will be without reception until his new antenna is installed. You can install the Futuramic *now* — before the rush starts! It will provide *better* reception than conventional Yagis on the *present* channels—and when the shift occurs, this superior reception will continue on the new channel without interruption!

### Areas in which a new VHF station is being added to the present one.

The hundreds of thousands of single-channel Yagis now in use will not bring in the new channel. This means that an additional Yagi will have to be purchased and tied into the present installation with a separate lead, through an annoying switching system. However, one Futuramic will do the job of both antennas — at lower cost — with better results on both channels. Install the Futuramic now to improve your present picture. And at the same time be ready for future channels on the same band.

### Areas served at present by two or more VHF stations (on the same band).

In such areas, the installation man must choose between conventional broad band antennas and separate Yagis for each channel. Each approach has important advantages. Only the Futuramic will give you the advantages of EOTH, combining highest gain, and sharpest directivity on each channel with simple, economical installation.

Model No.	Channels Covered	List Price
1173	7, 8, 9, 10, 11, 12, and 13	<b>\$20<sup>83</sup></b>
1124	2, 3, and 4	
1125	2, 3, 4, and 5	<b>\$40<sup>97</sup></b>
1136	3, 4, 5, and 6	
1146	4, 5, and 6	

#### GAIN CURVES

Model 1124

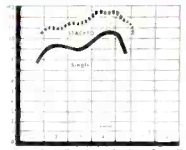

Covers Ch. 2, 3, 4

Model 1125

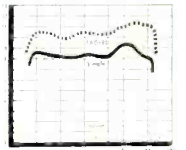

Covers Ch. 2, 3, 5

BOOM-BE-CKED

Horizontal Polar Plot

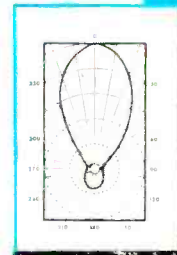

Model 1146

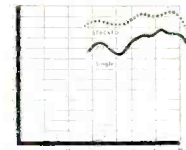

Covers Ch. 4, 5, 6

Model 1173

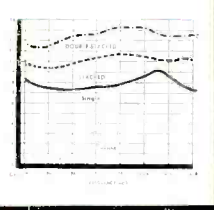

Covers Ch. 7, 8, 9, 10, 11, 12, 13

Model 1136

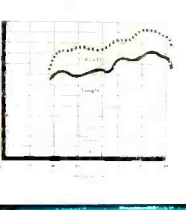

Covers Ch. 3, 4, 5, 6

### ALL THIS AND Z-MATCH TOO!

The Futuramic uses Channel Master's famous Z-Match system which eliminates mismatch, gives maximum stacking gain, and provides stacking bars at no extra cost.

## SHATTERS all performance records!

- Channel for channel, the Broad Band Futuramic will outperform any conventional SINGLE-CHANNEL Yagi!
- On each of its specified channels, one single Low Band Futuramic will outperform any 4-bay conical or fan array!
- A single High Band Futuramic will outperform any 2-bay conical or fan array on every channel from 7 to 13!
- A high-low Futuramic combination is the most sensitive array ever devised for all-channel VHF reception!

Write for complete technical literature.



**CHANNEL MASTER CORP.** ELLENVILLE, N.Y.



# 3 REASONS WHY

## Sylvania Picture Tubes keep customers happy!

**GOOD NEWS FOR  
YOUR CUSTOMERS...  
GOOD BUSINESS  
FOR YOU.**

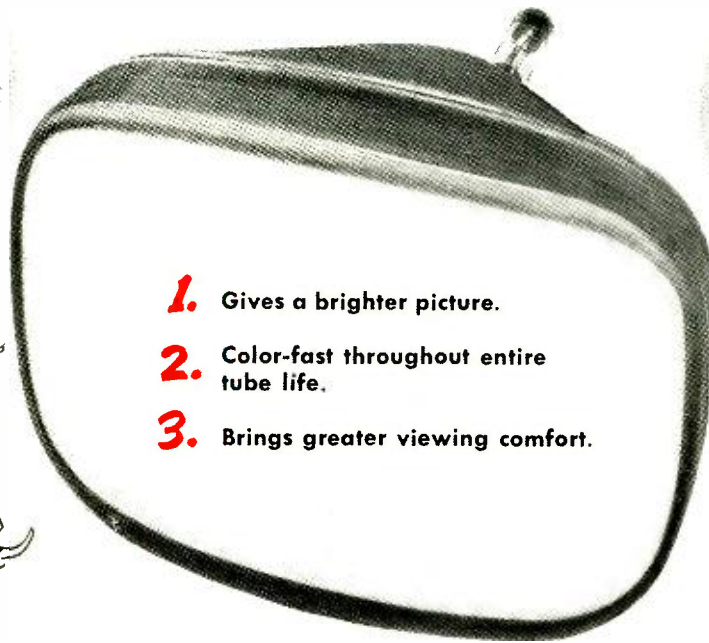

- 1.** Gives a brighter picture.
- 2.** Color-fast throughout entire tube life.
- 3.** Brings greater viewing comfort.

**THE SCREEN'S  
BETTER  
3 WAYS.**



Sylvania's years of research in fluorescent phosphors and lighting techniques have resulted in a vastly improved picture-tube screen.

This screen gives an increased light output over former screens . . . particularly when the tubes are operated at voltages below 14 kilocycles.

The face of this Sylvania screen is a restful blue-gray color for maximum viewing comfort. And, it is absolutely free from any discoloration . . . throughout the entire life of the tube.

So remember, you'll win more satisfied customers . . . good business and good will . . . when you install picture tubes trademarked *Sylvania*. For prices and complete information mail the coupon NOW!

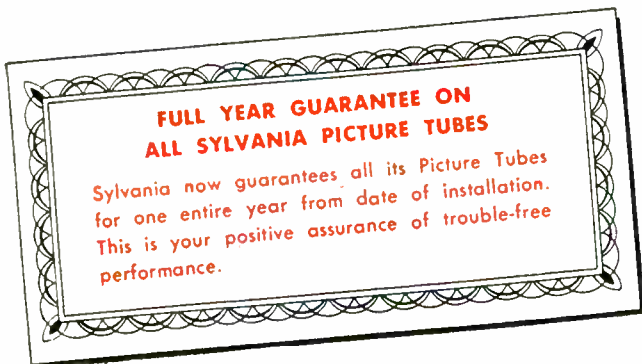

# SYLVANIA

 RADIO TUBES; TELEVISION PICTURE TUBES; ELECTRONIC PRODUCTS; ELECTRONIC TEST EQUIPMENT; FLUORESCENT TUBES, FIXTURES, SIGN TUBING, WIRING DEVICES; LIGHT BULBS; PHOTOLAMPS; TELEVISION SETS

**Sylvania Electric Products Inc.**  
**Dept. R-2710, 1100 Main Street**  
**Buffalo 9, N. Y.**

Please send me full information about the improved screen on Sylvania Picture Tubes.

Name \_\_\_\_\_

Street \_\_\_\_\_

City \_\_\_\_\_ Zone \_\_\_\_\_ State \_\_\_\_\_





# TEST ANY TV PICTURE TUBE

without removing it from cabinet!

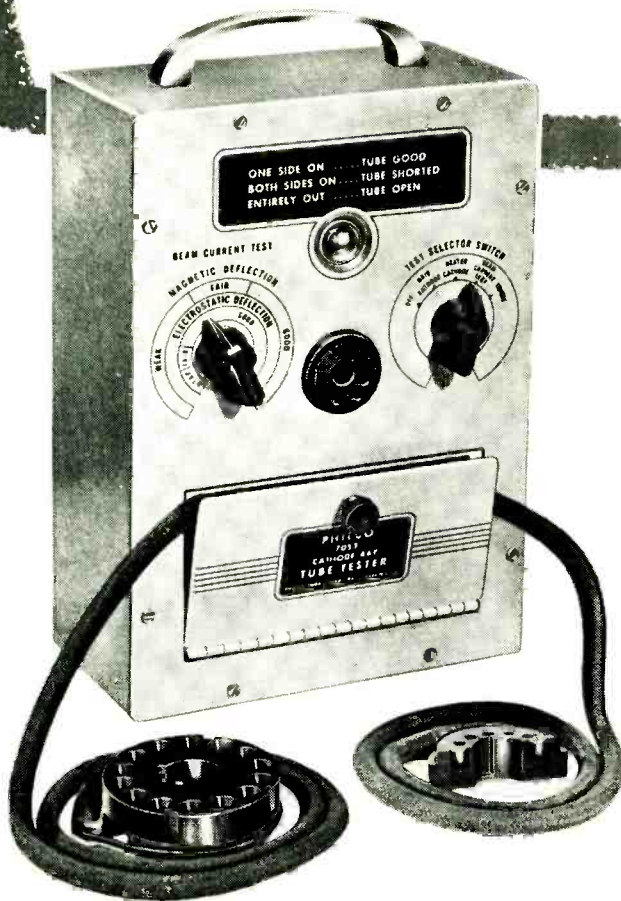
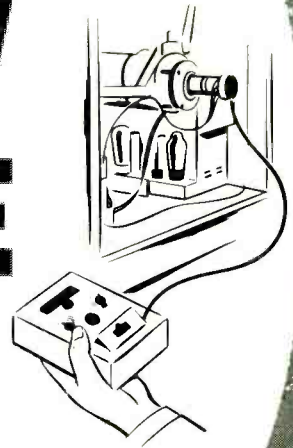

ACTUAL SIZE ONLY 8½" x 6" x 3"

- Tube elements are tested under simulated operating conditions assuring a realistic check of performance.
- Neon lamp bridge peak system instantly shows how each function of tube is operating.
- Large readable dials. Protective metal case. Comfortable-to-grip handle. Padded base.

**ORDER NOW FROM YOUR  
PHILCO DISTRIBUTOR**

## PHILCO

### Cathode Ray Tube TESTER

"Tells in a split second  
whether tube is good,  
shorted or open"



**Model 7053**... The instrument every TV serviceman has needed is here from Philco at a low cost all will welcome. In a few calls it pays for itself by quickly performing a service that formerly may have taken hours! Completely equipped with line cord and standard plug, 2 CR tube sockets with cables and built-in octal socket for testing Special Tubes. Attractively finished metal case provides storage space with hinged lid for cables and sockets. Yes, a complete test instrument of famous Philco quality, in compact, handy size. See it. Try it. You'll agree... for TV service today, it's a must!



# Here's your Opportunity

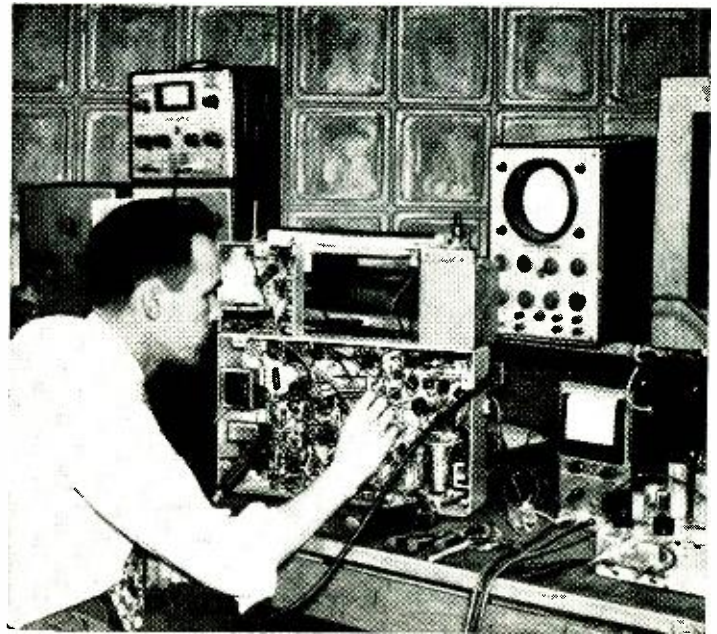

## to prepare for a good job or a business of your own in TV SERVICING

**There are today more good jobs** open in TV Servicing than there are trained and experienced men to fill them. Yes, thousands of opportunities exist now for good-pay jobs offering employment security for years and years to come. Thousands of TV Servicing jobs are going begging. Do you want one of them?

Experts agree, that because of the critical shortage of trained and experienced TV Servicemen, and the tremendous future growth of the industry, no vocational field today offers more opportunities than TV Servicing.

### The Big New Industry with a Great Future

Television is just in the beginning stages of its big industrial boom. Look at these amazing facts:

- Lifting the freeze on new TV stations will open many new TV areas and will improve the coverage of existing areas. The result will be an enormous demand for TV receivers.

- Within a few years over 1000 TV stations will be telecasting compared with 108 TV stations now on the air.
- Nearly one-half of all families living within the present TV areas do not yet own TV receivers.
- The new trans-continental video network plus better and more interesting programs plus larger viewing screens and color TV will increase the installation of new receivers, will induce present owners of 12-inch and smaller size viewing screens to buy newer model receivers.
- The power increases of many existing stations and improved reception range of current receivers will result in receivers being installed and serviced in the fringe areas of present stations.
- Under the FCC proposal, over 70 per cent of all communities will be served by UHF channels exclusively. This means TV servicemen must know UHF receivers before the new UHF stations in their area are opened.

- No one yet knows how great the industrial TV market will be.

### RCA Institutes Home Study Course prepares you for a Career in TV Servicing

The addition of the RCA Institutes TV Service Training to your present radio-electronics experience will qualify you to step out and grasp the golden opportunities that now exist in television—America's fastest growing industry.

Learn at home—in your spare time—while you study the practical *how-to-do-it* techniques with *how-it-works* information. Easy-to-read and easy-to-understand lessons under the supervision of RCA engineers and experienced instructors quickly train you to qualify for the many good jobs now waiting for trained TV servicemen. Don't pass up this lifetime opportunity for financial security and a bright future in TV. Learn TV Servicing from RCA—pioneers and leaders in radio, television and electronic developments.

RCA Institutes conducts a resident school in New York City offering day and evening courses in Radio and TV Servicing, Radio Code and Radio Operating, Radio Broadcasting, Advanced Technology. Write for free catalog on resident courses.

## Send for FREE BOOKLET

Mail the coupon—today. Get complete information on the RCA INSTITUTES Home Study Course in Television Servicing. Booklet gives you a general outline of the course by units. See how this practical home study course trains you quickly, easily. Mail coupon in envelope or paste on postal card.



### MAIL COUPON NOW!

RCA INSTITUTES, INC., Home Study Department RE-1052  
350 West Fourth Street, New York 14, N. Y.

Without obligation on my part, please send me copy of booklet "RCA INSTITUTES Home Study Course in TELEVISION SERVICING." (No salesman will call.)

Name \_\_\_\_\_  
(please print)  
 Address \_\_\_\_\_  
 City \_\_\_\_\_ Zone \_\_\_\_\_ State \_\_\_\_\_



**RCA INSTITUTES, INC.**  
 A SERVICE OF RADIO CORPORATION OF AMERICA  
 350 WEST FOURTH STREET, NEW YORK 14, N. Y.





In the CBS-Columbia design laboratories, Al Goldberg takes some important readings with the EICO Model 221 Vacuum Tube Voltmeter and Model 555 Multimeter as Harry R. Ashley looks on.

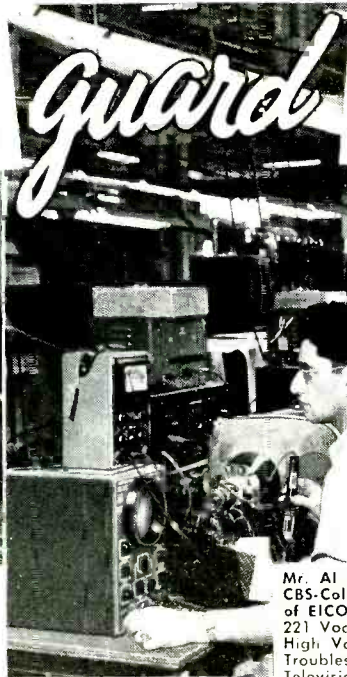

Mr. Al Goldberg, Assistant Chief Engineer of CBS-Columbia and Harry R. Ashley, President of EICO, inspecting the use of the EICO Model 221 Vacuum Tube Voltmeter and Model HVP-1 High Voltage Probe at the Sweep Frequency Troubleshooting Position on the CBS-Columbia television production lines.

**CBS-Columbia Inc.**  
HIGH STANDARDS OF  
TELEVISION PRODUCTION QUALITY

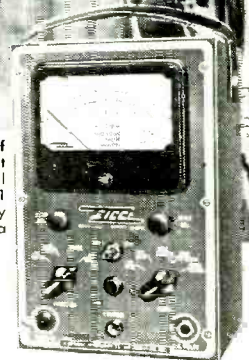

221K VTVM KIT \$25.95  
WIRED \$49.95



HIGH VOLTAGE  
PROBE \$6.95



425K 5" PUSH-PULL  
SCOPE KIT \$44.95, WIRED \$79.95

**KITS**  
WIRED INSTRUMENTS

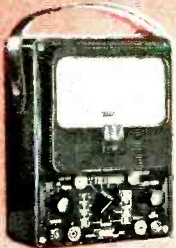

NEW 565K MULTIMETER  
KIT \$24.95 WIRED \$29.95  
20,000 ohms/volt



320K SIG. GEN. KIT \$19.95, WIRED \$29.95

322K SIG. GEN. KIT \$23.95, WIRED \$34.95

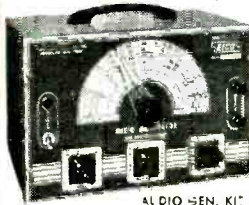

NEW 377K Sine & Square Wave  
AUDIO GEN. KIT \$31.95 WIRED \$49.95



950K R-C BRIDGE &  
R-C COMP. KIT \$19.95  
WIRED \$29.95



NEW 214K  
VTVM KIT \$34.95  
WIRED \$54.95  
7 1/2" METER



NEW 536K MULTI-METER KIT \$12.90  
WIRED \$14.90  
1000 ohms/volt

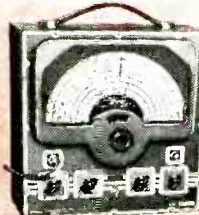

315K DELUXE SIG. GEN. KIT \$39.95  
WIRED \$59.95



625K TUBE TESTER KIT \$34.95  
WIRED \$49.95

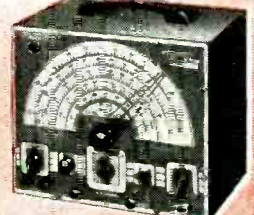

360K SWEEP GEN. KIT \$34.95  
WIRED \$49.95



1045K BATTERY EBM. KIT \$25.95, WIRED \$34.95



3171K RES. DECADE BOX KIT \$19.95  
WIRED \$24.95



145K SIG. TRACER KIT \$19.95  
WIRED \$28.95



NEW CRA PIX TUBE ADAPTOR for above \$4.50

For Laboratory Precision at Lowest Cost—the Leaders Look to **EICO!**

**WHY** does CBS-Columbia, Inc., one of America's great headline-makers in Television set production, use **EICO** Test Instruments on both its new Television production lines and in its design laboratories?

**BECAUSE** — like Emerson, Tele-King, Teletone, Majestic, and many another famous TV manufacturer coast to coast, CBS-Columbia knows that . . .

Only **EICO** Test Equipment delivers All 10 **EICO** nomical Features!

1. Laboratory Precision
2. Lowest Cost
3. Lifetime Dependability
4. Speedy Operation
5. Rugged Construction
6. Quality Components
7. Latest Engineering
8. Super-Simplified Assembly and Use Instructions
9. Laboratory-Styled Appearance
10. Exclusive EICO Make-Good Guarantee

Before You buy any higher-priced equipment, look at the **EICO** line—in *Wired and Kit form!* Each **EICO** product is jam-packed with unbelievable value. Compare, see **EICO** instruments today—in stock at your local jobber—and **SAVE!** Write NOW for FREE newest Catalog 10-C.

**FOLLOW THE LEADERS . . . INSIST ON EICO!**



Reg. U. S. Pat. Off.

**ELECTRONIC INSTRUMENT CO., Inc.**  
84 WITHERS STREET, BROOKLYN 11, NEW YORK

©1952 Electronic Instrument Co., Inc. Prices 5% higher on West Coast. Due to unstable conditions, prices and specifications are subject to change without notice.



# Our Electronic Universe

... The heavens are the major producer of all electrons ...

By HUGO GERNSBACH

**E**XACTLY 30 years ago the writer authored an article entitled "The Celestial Audion" (*Radio News*, July, 1922). This article showed the surprising close parallelism of the vacuum tube with the solar system. Just as the filament or cathode of the vacuum tube constantly emits electrons which bombard the "empty" space and the elements in the tube, so the sun, too, emits electrons on a gigantic scale which bombard the earth, moon, and other planets, through space.

When, due to sunspots or other atomic activity, the flow of solar electrons is increased, we, on earth, know it about 26 hours later, for it takes this particular electronic flow—traveling at the rate of 994 miles a second—that length of time to bridge the 93 million miles separating us from the sun. Magnetic storms on earth, which disrupt wire and radio communication, the flaming up of the *aurora borealis*—the northern lights—are only a few of the phenomena noted by us when solar electronic activity increases.

Even without a sudden increase of solar electron radiation, we are under continuous electronic bombardment from the sun. Nor is this solar energy which the earth intercepts trifling. Scientists today are certain that most of the magnetic field of the earth is created chiefly by solar electronic emission.

That the sun is indeed a gigantic radio transmitter was confirmed again in September 1951 and February, 1952. A French scientific expedition on the African River Niger made a number of significant radio observations during solar eclipses. It was noted that with a specially constructed wave guide a considerable amount of radio energy was intercepted on centimeter wavelengths. Nor did the radio energy originate from the center or the edge of the solar disc. It appears that the radiation comes from *outside* the solar surface. As the scientists put it: "the radioelectronic sun's diameter is 70% larger than the optical sun." It thus appears that the sun's corona is also a radio emitter.

But our sun is not the only celestial radioelectronic transmitter. There are hundreds of millions of other stars in the universe and practically all of them send us similar radio energy. Naturally, due to the enormous intervening distances, the intercepted energy received on earth is trifling. Nevertheless, our new radio telescopes, now springing up all over the globe, collect these celestial radio waves and measure their frequency and energy accurately.

Not all of the myriad suns in the universe are alike. All vary in age, size, and composition. Thus our sun is a moderate-size star, fairly young—about four billion years old, and will probably last 50 billion years more according to cosmologists.

Other stars *much* larger than the sun have a different life cycle. These, called super-giants, are colossal in size, but when their hydrogen supply becomes exhausted, the star shrinks, or begins to collapse rapidly. Now it starts to radiate a different type of electronic energy—hard, powerful X-rays. Finally the super-giant in its death throes explodes with a force that would make the detonation of a million man-made atomic bombs, set off together, seem like a harmless firecracker. The exploding star has now become a *supernova*, such as we see flaring up in our skies periodically. Nevertheless, even after such a massive world-explosion, the supernova lives on a while. According to Prof. Fred Hoyle of Cambridge University, about 10% of the original star remains after the explosion. At this point the supernova emits the most powerful rays known to man, namely: cosmic radiation.

Inasmuch as there are many millions of different types of *novae* throughout the whole universe, continuously radiating cosmic rays, our earth intercepts unending streams of this still little understood electronic super-radiation.

Most cosmologists today are agreed that the universe has neither beginning nor end, startling as the idea is to most of us. Space and universe are one entity—you cannot well conceive one without the other. Even a truly empty space cannot be conceived as not having existed at one time.

More surprising still is the theory recently advanced by scientists. It is called *continuous creation*. This in its simplest terms means that the universe can never run down—it will live on forever. It has been shown mathematically that the fuel on which all suns feed is hydrogen—the most abundant material throughout the universe, which means throughout infinite space. (Let us not forget too, that hydrogen is composed of one negative electron, and one positive proton.) Far more startling is that in order to keep all the billions of stars, big and little, supplied with fuel, it is only necessary to continuously create *one single* hydrogen atom in a space as large as a medium skyscraper, *once a year*. But we must consider the immensity of universal space to realize how these lone atoms will nevertheless in the aggregate add up sufficiently to run the universe composed of millions of galaxies and billions of stars.

But cosmologists are silent when it comes to explaining *how* the hydrogen atoms are created continuously. They are no more concerned with this than to explain *what* gravitation is or how *it* is created. They merely say, as does Hoyle: "Where does the created material come from? It does not come from anywhere. It simply appears—it is created."

What practical benefit do we derive from the electronic universe? For one thing we learn many new electronic facts and we greatly enrich our present knowledge. We learn that electric radiation can be produced *directly* from the atom—achieved only as a laboratory curiosity today—but a commercial possibility tomorrow.

It will also be possible in the future to tap the sun for its electrical energy. This may be difficult to accomplish on earth for some time, due to our atmosphere which now hinders reception. But on the moon this obstacle vanishes. As it will not be very long now before we reach the moon, solar-electric generation stations are certain to be built for power purposes, to smelt lunar metals, for lighting and heating and many other purposes.

But it is in the cosmic radiation where our greatest hope in the future centers. These unbelievably powerful rays have such vast energy that they not only pass easily through our atmosphere but penetrate far into the earth without difficulty. Cosmic rays have been detected in mines over a mile below the earth's surface. As it takes around three billion volts for these rays to penetrate to the bottom of our atmosphere, an idea can be gained of this gigantic radiation. It seems certain that some day this stupendous energy will be harnessed for man's use. When that happens it may well revolutionize our lives.

This sketchy account of our electronic universe does not even begin to scratch the outer film of the subject. Let us ponder that our infinitesimal knowledge of this fascinating study is less than one hundred years old, and that the *local* electronic universe—our own galaxy—according to the latest researches, has been functioning uninterruptedly for over five billion years!

# CONVERTERS for U.H.F. TV

Commercial units  
for receiving the new  
u.h.f. channels  
on your present TV set.  
Continuous-tuning  
models give complete  
coverage.



Fig. 2—Kingston continuous-tuning u.h.f. converter.

By **FRED KING\***

WHEN TV channels 14 through 83 were proposed for the 470-890-mc portion of the u.h.f. spectrum manufacturers had to assure prospective buyers that their sets would not become obsolete but could be adapted to the new channels.

Converters had to be designed which could be used with the millions of sets already in existence and which could be attached simply, without making changes in the internal wiring. Later—when the new stations actually got onto the air—newer designs would be needed with the u.h.f. section as an integral part of the chassis.

Very few persons had experience in this band (too low for microwave techniques and too high for conventional lumped-constants design). No signal generators or precise measuring equipment were available and few tubes were suitable for these frequencies, where the capacitance of an inductor and the inductance of a capacitor really amount to something.

Most converter designs operate on the

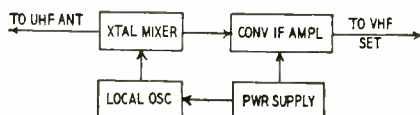

Fig. 1—Block diagram, u.h.f. converter.

\* Chief Engineer, Radio Station WELI  
New Haven, Conn.

double superheterodyne idea with output on one of the v.h.f. channels which then becomes an intermediate frequency. This is popularly designated as the converter i.f. See Fig. 1 for a block diagram of the typical u.h.f. converter.

Early experiments showed that vacuum-tube r.f. stages and mixers resulted in a poor noise figure at u.h.f.

They were abandoned in favor of the microwave technique of using a crystal mixer with some sort of preselection between it and the antenna. The improvement was considerable and this system seems to have been adopted generally. The most popular germanium crystals for the mixer position are the G-E G7, the Sylvania 1N72, and the

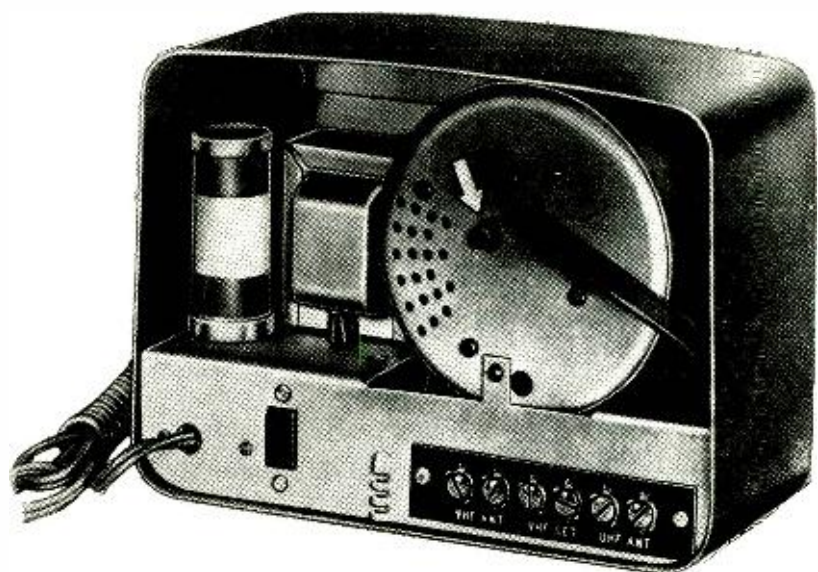

Fig. 3—Rear of Kingston converter. Large cylinder is the tuner.



Raytheon CK710 u.h.f. crystal diodes.

### Converter i.f. amplifiers

The incoming signal is attenuated about 9 db in the crystal mixer and a carefully designed low-noise intermediate-frequency amplifier is required in the converter to boost the signal level before it is applied to the input of the v.h.f. receiver. Most manufacturers use the famous cascode circuit, the driven-grounded-grid, or the direct-coupled driven-grounded-grid circuits, or some slight modification of these. The 6BZ7, 6BK7 and 6BQ7 low-noise miniature twin triodes were designed especially for these low-noise circuits.<sup>1</sup>

The choice of the v.h.f. channel used as the converter i.f. varies somewhat. A lower noise figure results with the use of the lower channels, while there is less oscillator radiation and fewer images and other spurious responses if the higher channels are used. The popular all-around compromise seems to be channel 5 or 6 (with some means of adjusting the converter to either). This is necessary, as a strong local v.h.f. signal may ride in and interfere with the converted v.h.f. signal on one or the other channel.

The Crosley *Ultra-Tuner* does not have this problem, as it uses 127 mc for the converter i.f. This is possible because their v.h.f. receivers use the Mallory *Inductuner* and can tune the spectrum between channels 6 and 7.

### U.h.f. oscillators

The u.h.f. oscillator must be tuned to the low side of the received signal to maintain the proper relation between the sound and picture carriers. The 6AF4 tube is the most popular in this position because of its small lead inductance, tube capacitance, and transit time.

Oscillator drift loomed as a serious

problem in early converters. When used to feed v.h.f. sets with separate sound and picture i.f. systems they drifted so badly that the critical FM sound tuning had to be adjusted every few minutes to compensate for it. When used with intercarrier sets this frequent adjustment was unnecessary, as the sound information is taken from the 4.5-mc beat between the two carriers, which are kept within close tolerances with precise equipment at the transmitter. This probably helped to influence some manufacturers to change over to the intercarrier sound design. The oscillator drift was reduced tremendously in newer model converters with new designs of circuit elements and tubes.

### Oscillator radiation

One would think that oscillator radiation through the antenna would be less intense with a converter using an r.f. stage and tube mixer. This is not the case at u.h.f.<sup>2</sup> The crystal mixer requires less oscillator injection power to operate efficiently than vacuum-tube mixers and so there is less power to get through to the antenna. Radiation direct from the chassis is another problem and can be controlled by proper shielding and design.<sup>3</sup>

### Converter design

The geniuses of design approached their individual problems from different angles, depending to a great extent on the front-end design of their present and past v.h.f. receivers. This makes it possible to group converter design into three general categories as follows:

#### 1. Continuous-tuning type

Manufacturers not using the turret type v.h.f. front end designed converters built in small cabinets with self-contained power supply that resemble the conventional booster. They have the ad-

vantage of being able to tune the entire 70 channels from 470 to 890 mc. They have the disadvantage of being an external accessory and are more confusing for the nontechnical public to operate.

Some examples of this type of converter are: RCA, G-E, Crosley, Mallory, Stromberg-Carlson, Sylvania, Bendix, Kingston, Arvin, Philco, Dumont, Sarkes Tarzian, and Sutton.

#### 2. U.h.f. strip type converter

Manufacturers who had consistently used the turret type v.h.f. tuner could go ahead with the design of a converter with the lumped constants and crystals mounted on a replaceable individual segment of the turret. These strips can be inserted in unused positions of the v.h.f. turret.

Advantages of this type are the operation is the same as for v.h.f. and there is no external accessory to be tuned. Also it is simpler and cheaper when only two or three u.h.f. channels are within range. The method has the disadvantage of requiring new strips if the TV set owner moves to a different city with different channel assignments, and distributors will require a considerable stock for the different channels used in any area and for different models of v.h.f. receivers. This type of converter is made by Zenith and by Standard Coil who supplies v.h.f. tuners for more than 60 manufacturers.

#### 3. Two- or three-channel switch type

A few companies have designed small converters for attachment to the back, bottom, or inside of the v.h.f. receiver with lumped constants pretuned to several selected channels and switched by pushbuttons or some mechanical extension. They may or may not obtain operating voltages from the TV set.

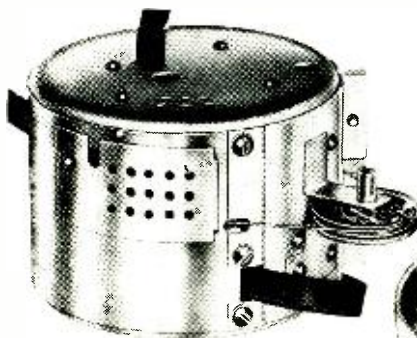

Fig. 4—Continuous u.h.f. tuner assembled in external shield.

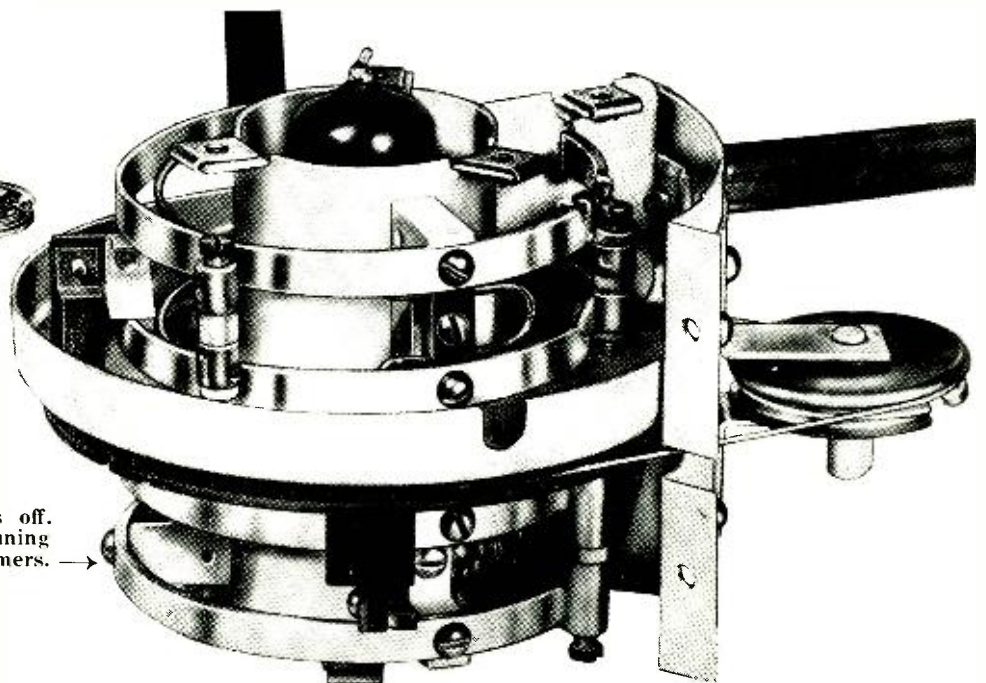

Fig. 5—U.h.f. tuner with shields off. Straps surrounding tube are tuning lines with cylindrical ceramic trimmers.

This type is simple and cheap when only a few channels are within range. Some recent v.h.f. receivers have provision for this type converter on the chassis. RCA, G-E, Philco, and Sarkes Tarzian have models using this idea.

### The Kingston converter

This converter falls into Type 1. The manufacturer is Kingston Products Corp. of Kokomo, Ind. Fig. 2 shows a front view of the complete converter. The three controls are off-on and u.h.f.-v.h.f. antenna change-over switch, channel selector, and fine tuning. The over-all dimensions are 8½ inches wide by 5¾ inches high by 4½ inches deep.

The basic tuner uses tuned-line microwave principles and its mechanical design is compact and practical. The tuner is 4 inches in diameter and 3 inches in depth. It is a continuous-tuning type using curved lines with sliding silver shorting bars for tuning. The 70 u.h.f. channels are covered in 340 degrees of rotation and the slide-rule type dial indicates the frequency in megacycles. One stage of i.f. amplification is included with the tuner.

In basic physical layout and construction it is suitable for any selected i.f. and is normally supplied with output on channel 10. If there are spurious responses, or if a strong v.h.f. signal rides in, the i.f. output trimmer—located on the rear of the tuner—may be adjusted for output on channels 8 through 12. In Fig. 3 the white arrow shows the exact location of this trimmer. This rear view also shows the terminal board with the u.h.f. and v.h.f. antenna and output connections.

Fig. 4 shows the u.h.f. tuner removed from the chassis but with all covers and shields in place. Fig. 5 shows the u.h.f. tuner with the shields removed. The preselector lines and sliders with their respective trimmers are at the top. The antenna coupling loop is behind the preselector line. The oscillator lines with slider and trimmer are at the bottom. The cascode i.f. amplifier tube is mounted in the center. An antibacklash drive and speed reduction are simultaneously obtained with a spring-

loaded dial cord around a molded bakelite ring to which the preselector and oscillator sliders are attached.

The r.f. circuit of the converter (Fig. 6) consists of a stationary balanced transmission-line type antenna coupling loop, a tunable preselector transmission line, and a crystal mixer. The oscillator and preselector lines are curved parallel strips of silver-plated brass, ¼ inch wide. Tuning with parallel lines of adjustable electrical length allows a large frequency range and simplifies tuning.

Two trimmer capacitors on the preselector lines simplify the tracking problem. One sets the high-frequency end and the other sets the low-frequency end of the range. Tracking the oscillator with the pre-selector circuits is a simple alignment operation.

The u.h.f. local oscillator uses the miniature 6AF4 triode capacitance-coupled to the quarter-wave short-circuited transmission line. It tunes from 275 to 695 mc. A trimmer capacitor across the plate tank circuit sets the frequency to any desired point at the low end of the range. The warmup drift of the oscillator is about 250 kc at the high-frequency end of the band and about minus 250 kc on the low end. The frequency stabilizes after five minutes of operation.

The converter i.f. amplifier uses a 6BK7 twin-triode tube in the familiar cascode low-noise circuit. It is series-coupled to the crystal mixer.

This converter has been tested over a 6-month period at a u.h.f. monitoring station maintained by WELI at New Haven. Reception of the Bridgeport RCA-NBC experimental u.h.f. station KC2XAK has been very satisfactory and no mechanical or electrical failures were encountered. END

#### References

- <sup>1</sup>Use of Low-Noise Twin Triode in Television Tuners, Robert M. Cohen. *RCA Review*, Volume XII, No. 1, March, 1951.
- <sup>2</sup>Some Design Considerations of Ultra-High Frequency Converters, Wen Yuan Pan. *RCA Review*, Volume XI, No. 3, September, 1950.
- <sup>3</sup>Reducing TV Receiver Oscillator Radiation, E. W. Chapin and Willmar K. Roberts (FCC). *Electronics*, July, 1952.

Mr. King will give us further information on u.h.f. conversion and converters in future articles in this magazine.

## TV DX REPORTS

October is an interim month in both weather and propagation conditions. TV reception can be expected to show both the extended range of late summer and the somewhat shortened coverage of early winter, before the month is through. It will not be a good month for the TV dx enthusiast who is looking for reception from 1,000 miles or more away, for sporadic-E skip is rare at this time of year. There may be an opening or two during the month, but signals will be generally poor, and the reception in most cases will be of short duration.

Tropospheric bending, on the other hand, may be as good as at any season. The warmer sections of the country will probably find October superior to September in this respect. The calm warm days and cool nights, variously known as Indian summer and World Series weather, produce stable air-mass stratifications that bend v.h.f. waves back to earth and bring fringe-area signals up to many times their normal levels.

The considerable extension of transmitter coverage that results may not be considered dx to some viewers, but it is great stuff to TV receiver owners who are outside normal primary service areas. For them October will mark the beginning of the end of the favorable conditions they have enjoyed during the spring and summer months.

Trees shedding their foliage will reduce absorption and increase signal levels in locations where the antenna is screened by nearby trees. This effect will be more marked on the higher channels, and it will tend to make up for the gradual dropping off in signal levels that might otherwise be expected at this season.

Aurora borealis is common in October, showing up frequently in our more northern states. It may be observable down to the Mason-Dixon Line, or even farther south on a few rare occasions.

The principal effect on TV reception, when any is found at all, is usually in the form of indefinite streaks. Such interference is more readily detected when the array is aimed in a northerly direction, and is most pronounced on the lower channels.

The ability of the aurora to reflect v.h.f. signals varies widely. Careful observation of aurora-reflected TV signals is needed, and the readers' assistance in this respect is earnestly solicited. Please report all effects—or suspected effects—of aurora borealis on your TV reception, with full details such as date, time, duration, type and orientation of antenna, and how the aurora looks, if visible. END

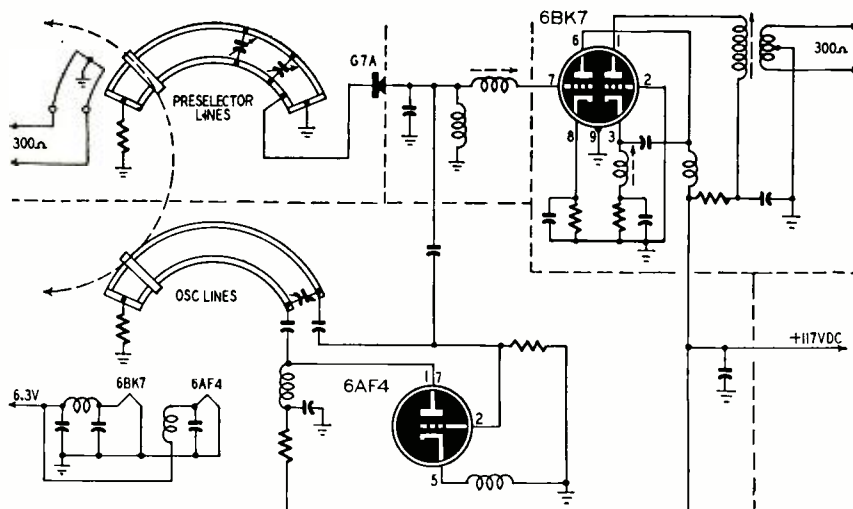

Fig. 6—Signal circuits of the Kingston converter. Output is on channel 10.



# CONVERTING A SET WITH RF SUPPLY

Package-type flyback unit modernizes many small-screen models

By J. V. CAVASENO

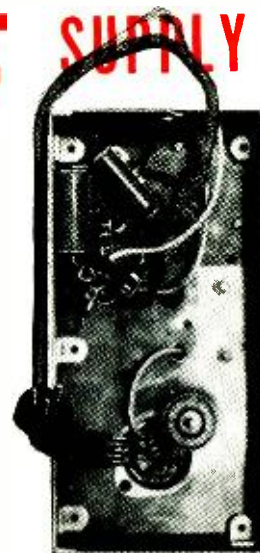
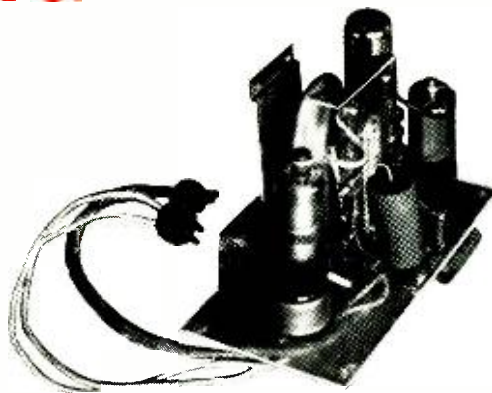

A NUMBER of the early 10- and 12-inch TV sets were built with r.f.-type high-voltage supplies instead of the now-standard flyback system. Many of these sets are still in operation and are giving satisfactory service. Their only objectionable feature is a screen which is too small by today's standards.

When TV conversions became a large-scale business, many service technicians claimed that sets with r.f. supplies were unconvertible. Others passed them up in favor of easier-to-convert models which have flyback power supplies. Now that the easier conversion jobs are pretty well cleaned up, those sets with r.f. power supplies represent a good share of the conversion jobs yet to be done.

Contrary to popular opinion, these sets are just about as simple to convert as those having flyback supplies. Of course, the job takes a little longer because the modifications are more extensive. (Before going further, I must stress that this discussion refers only to those sets which have *electromagnetic* deflection systems. The jobs using electrostatic deflection can be handled best by constructing a big-screen electromagnetic slave unit like that described in the August, 1951, issue of RADIO-ELECTRONICS.) You can tackle those r.f. conversion jobs and make them pay simply by following my method.

Realizing that the major circuit differences are in the horizontal output stages of sets using the two types of power supplies, I decided to junk the old r.f. supplies and start from scratch. Some of the earlier sets operate with B voltages as low as 240, so I determined to construct a universal horizontal output and high-voltage circuit which could be added to almost any set. The circuit would have to supply enough width and brightness for a 17-inch tube.

## Flyback circuit

The first set that I tackled was an Andrea VJ12. First I removed the 6Y6-G high-voltage oscillator and 6BG6-G output tube and all other related com-

ponents from the small high-voltage chassis. I mounted a flyback transformer in the center of the stripped chassis between the two octal sockets. Needing a third socket, I mounted it on 1½-inch long polystyrene rods on one corner of the chassis. I now had sockets for a 1B3-GT high-voltage rectifier, 6W4-GT damper and 6BQ6-GT.

After some experimenting, I found that the circuit in Fig. 1 delivers enough high voltage and width to drive a 20-inch tube. I haven't tried a 24-incher but I believe that this unit will drive one equally well. The flyback transformer can be a Stancor A-8130, RCA 231T1, Ram XO35, Merit HVO-6, G-E 77J1, Du Mont H1A1, Halldorson TV-14, or equivalent. For good focus, use a cosine yoke whose impedance matches the flyback used. I used a 201R10 width coil. No linearity coil was needed.

## Oscillator modifications

The 6BG6-G horizontal output tube and the 6AS7-G damper and their components were removed from the horizontal output cage. I redesigned the oscillator circuit as shown in Fig. 2 to produce a flat-topped sine wave which I fed to the grid of the discharge tube which also underwent minor modifications. After changing the values of the grid and plate load resistors, and removing the width control, we supplied the discharge tube with 240 plus. The circuit now gives a sawtooth of the greatest amplitude possible with good linearity. No changes were made in the a.f.c. (6AC7 and 6AL5) circuits.

The VJ12 has a 4-wire cable between the main and high-voltage chassis. I used this to supply the small chassis with heater voltage, 240 volts plus, and ground. Two wires were added to the cable to carry the sawtooth from the discharge tube to the grid of the 6BQ6, and to carry the horizontal sweep signal to the yoke which plugs into the main chassis. Of course, if you are working on a different make or model, you may need more or fewer wires.

Some sets already produce a good sawtooth waveform, so their oscillators

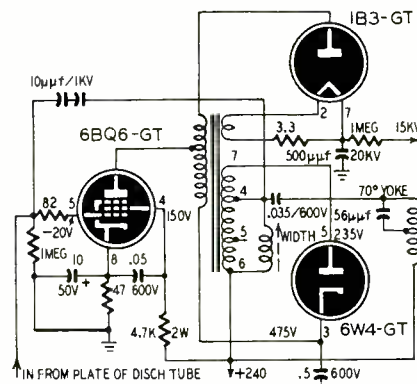

Fig. 1—Horizontal-output and h.v. unit used for conversions to 20-inch tubes.

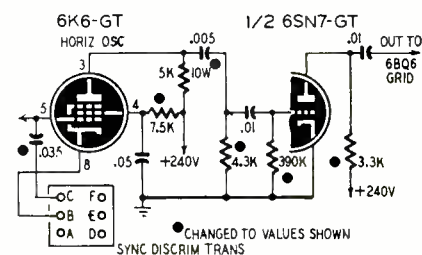

Fig. 2—Changes made in Synchrolock horizontal oscillator-discharge circuit.

do not have to be modified. In this case, the high-voltage and deflection circuit is all that is needed. The circuits in Figs. 1 and 2 can be used to modernize such sets as the Westinghouse H-242, H-251, and similar models, and give plenty of width and brightness. Too much width can be remedied by reducing the B plus supply to the high-voltage, by trying different width coils, or by using larger resistors in the cathode and screen circuits of the 6BQ6-GT.

Before tackling a conversion of a set with r.f. power supply, study its diagram very carefully and compare the circuits of the output stage and horizontal oscillator with those in Figs. 1 and 2. Then follow through along the lines that I have discussed and you will be as pleased with the finished job as I am with the jobs that I have done.

END

# THE EIDOPHOR PROJECTOR

Theater TV system makes possible full-color pictures of unlimited size and brightness

By AARON NADELL



Fig. 1—The Eidophor equipment. Light beam comes from the projector hood 2.

**B**ELIEVE it or not, *this* television has a built-in refrigerator! It also shares with the electron microscope the distinction of a continuously acting vacuum pump. Its electron gun does not bombard a phosphor that glows, but a liquid that dimples! Its electron beam is velocity-modulated. The illumination that makes the image visible to the beholder comes, not from the electronic bombardment, but from an arc lamp. This new system of theater television that produces a full-screen size, full-color image without a cathode-ray tube (although it uses an electron gun), is called Eidophor, from the Greek: *eidolon* (image) and *phoros* (bearer or carrier). Eidophor is an image-carrier. (Of course the "phor" part of the word has the same root as in "phosphor"—light-carrier from *phos*, *photos*, meaning light, and *phor* as bearer or carrier.) It constitutes the motion picture theater's latest answer to the competition of video in the home.

Eidophor is the property of 20th Century-Fox Film Corporation. As recently demonstrated in their New York preview theater, the equipment filled a screen 15 feet wide with a color picture so bright and detailed that some visitors thought they were seeing a Technicolor movie and asked when the TV demonstration was going to start.

The system combines some of the most intricate achievements of electronic engineering, electrical engineering, and the optical, mechanical, and chemical sciences.

Original invention is credited to the late Dr. F. Fischer, Professor of Applied Physics at the Swiss Federal Institute of Technology, who applied for a basic patent in 1939. He was assisted by a group of collaborators at the same

institution and at Zurich. Rights to the system were acquired by Spyros P. Skouras, president of 20th Century-Fox. It was simplified and reduced to more manageable dimensions, with color added, by Earl I. Sponable, who is 20th Century-Fox's chief of research and past president of the Society of Motion Picture and Television Engineers.

Fig. 1 illustrates the complete equipment as used for the recent New York demonstration. The cabinet numbered 4 houses the refrigerator and vacuum pump. The item numbered 5 is the arc lamp. This particular lamp burns an arc current of 125 amperes. If more screen light or a still larger screen are desirable, there is no apparent reason why a more powerful arc should not be used—large theaters and drive-in theaters burn up to 200 amperes. The shield numbered 3 covers the rotating color wheel: Eidophor uses the CBS field-sequential color system at present. The item numbered 2 is the hood from which the light-beam emerges to illuminate the theater screen; cabinet 1 is the projector proper, the mechanism in which the TV signal is converted to a visible image. There are two other cabinets, which contain conventional TV control and power-supply circuits.

Fig. 2 diagrams the essential details of the projector; and shows their relationship to item 1, the arc lamp, and to item 12, the theater screen. Here the sciences of electronics, optics, mechanics, and chemistry are combined.

The action in general (leaving details till later) is as follows: A beam of electrons, velocity-modulated by a TV signal, bombards a semiconducting surface consisting of an oily liquid. This liquid is optically located in the path of a light-beam, the origin of which is the electric arc. When there is no signal on

the electron gun the surface of the liquid remains unruffled and the light that reaches it is reflected back to the arc whence it came. Wherever, and to the extent that, the cathode ray is modulated by signal, the surface of the liquid is ruffled proportionately. The light is deflected by the wavelets or dimples thus formed, and instead of being returned to the arc lamp is shifted slightly to another course which terminates at the theater screen.

The field sequential color system is well known: By reason of synchronized color wheels on camera and projector each successive field is seen by the camera, and shown by the projector, in one of the primary colors only. These successive red, blue, and green fields are merged by the eye into a single full-color image, through the phenomenon of persistence of vision.

The electron beam, item 6 of Fig. 2, may now be examined in some detail. From the diagram it can be seen that both magnetic and electrostatic deflection (two coils and one pair of plates) are used. There are other peculiarities also. For example, an oxide cathode is impossible. The Eidophor liquid is bombarded, not only by a 20-kv electron beam, but also by the heat of an arc lamp (item 1 of the figure)! Despite the remarkable chemical achievement of an *almost* nonvolatile liquid, evaporation takes place; and despite the best efforts of the vacuum pump a low concentration of hydrocarbon vapor exists in the vacuum chamber. It has been found that oxide-coated cathodes are incompatible with this situation. A rod of pure tungsten is used instead.

Another peculiarity: A cathode, normally the negative terminal, is not necessarily negative in Fig. 2; but is negative only to its own anode, the Eidophor



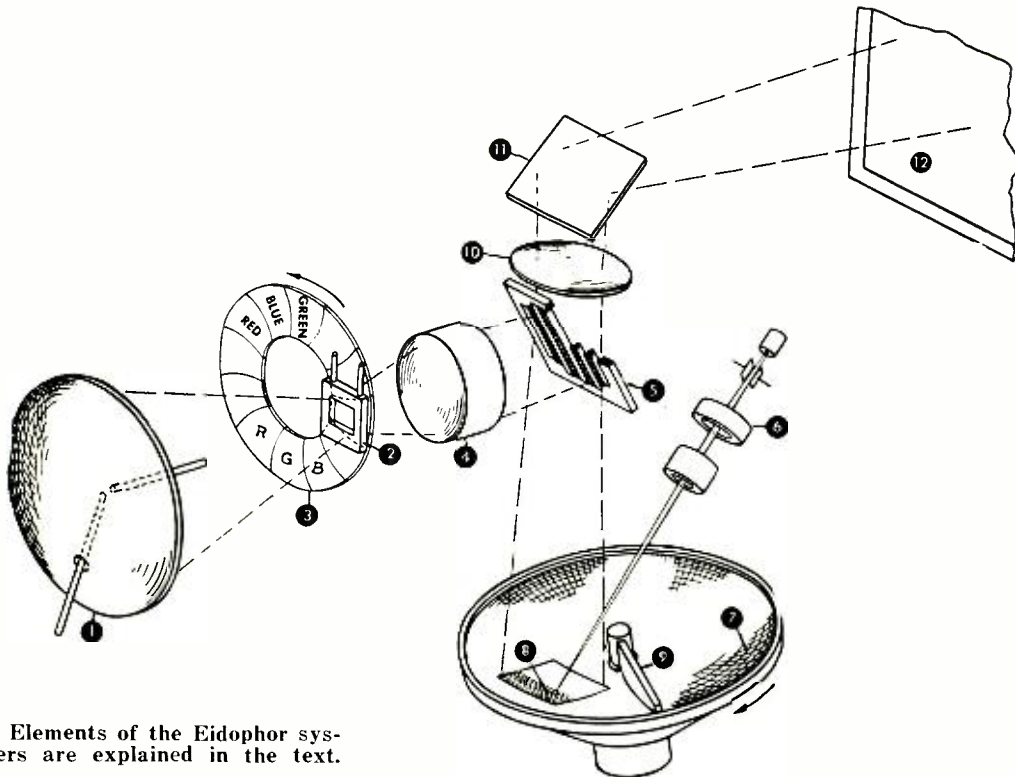

Fig. 2—The Elements of the Eidophor system. Numbers are explained in the text.

liquid. It is an anode to an element not shown in the diagram, a helix of tungsten wire, which surrounds the tungsten rod. This wire is heated by passing a current through it, and radiation of heat from it warms the tungsten rod; but the temperature thus attained is not high enough to produce an electron beam of the required  $20 \mu\text{a}$ . Therefore the helix of tungsten wire is made very strongly negative with respect to the tungsten bar, and the bar in consequence is bombarded by electrons from the cathode. The combination of heat-from-radiation and heat-from-bombardment brings the cathode rod to the required emission; probably secondary emission helps here also, although such is not specifically stated in the information released. The potential difference between helix and cathode bar is not revealed either.

It might seem that the helix itself could be used as cathode for the system, dispensing with the bar, but apparently a point-source of electrons is needed and the helix area is too great. The cathode ray as it impinges upon the Eidophor liquid has a rectangular cross-section,  $0.004 \times 0.0006$  inches. To maintain this size and shape in the beam a mechanical diaphragm of tungsten, having exactly that same opening, is placed in the cathode-ray path at the point of electron crossover in front of the cathode. A 1:1 magnetic lens then projects the image of this diaphragm opening to the surface of the Eidophor liquid (item 8).

Scanning likewise is effected magnetically, but the velocity modulation is produced by the pair of electrostatic vanes shown in the diagram. There is no amplitude modulation: the density of the beam, and the area and shape of its cross-section upon the surface of the liquid, remain constant at all times.

The deflecting vanes are energized by a constant-frequency a.c., the amplitude of which varies inversely with signal strength. When the signal is weak the vane a.c. is strong and the beam is swept rapidly, depositing only a weak charge on the liquid as it hurries past. When the signal is strong the vane charge is weak and the beam moves more slowly, leaving a stronger charge.

The action of this bombardment on the Eidophor liquid may now be considered, after which this review of the system will be completed by tracing the action of the Eidophor liquid upon the light-beam.

Actual composition of the liquid has not been revealed. It is said to be essentially a hydrocarbon, to which unspecified ingredients have been added to provide a moderate degree of electrical conductivity. It has a minimum tendency to evaporate under the intense bombardments to which it is subjected. Finally its viscosity, for reasons that will be seen, is extremely critical.

Bombardment of the Eidophor liquid by the cathode ray amounts to depositing electrons onto and into it. It is desirable that these electrons remain essentially where placed for one picture period, and the conductivity of the liquid is adjusted accordingly. Mutual repulsion of the electrons deforms the surface of the liquid. The deformations are minute, their maximum amplitude being only a few thousandths of a millimeter. As the charge leaks off, these deformations subside. Their subsidence depends partly on the rate at which the charges leak off and partly upon the viscosity of the liquid. Hence this property of the liquid is critical; and since viscosity is a function of (among other things) temperature, refrigeration is essential. The refrigeration require-

ments are not particularly drastic (it is said the mechanism and controls of an ordinary household refrigerator are adequate) but they cannot be disregarded.

Presence of the Eidophor liquid also explains the need for the vacuum pump; evaporation being unavoidable, the vapors formed must be removed or the system will cease to function.

Item 7 in Figure 2 is a spherically curved mirror, upon the surface of which the liquid is coated, and which rotates slowly in the direction shown by the arrow. Rotation of the mirror serves three purposes: It constantly brings under the electron gun a fresh, cooled surface, and thus minimizes the refrigeration load. It removes from the area of bombardment a surface that has accumulated a certain constant charge, and presents a fresh surface from which the residual charge has had time to leak off. It passes the oily surface under a knife-edge (item 9) just before rotating it into the scanning area, thereby mechanically smoothing away any ripple or deformation that may have remained.

The optical arrangements upon which all these equipment items operate should not present much difficulty in description or understanding—although to design such a system is a very different matter! The arc lamp of Fig. 2 and the color wheel (items 1 and 3) are practically self-explanatory. The arc lamp is equipped with the conventional curved mirror that reflects and concentrates the light. Item 2 is a rectangular diaphragm. Just as the electron gun is fitted with a mechanical diaphragm to impart a desired rectangular shape to the cathode ray, so item 2 is a mechanical diaphragm which imparts the desired 4:3 rectangular aspect ratio to the

light-beam. Item 4 is a lens. Item 5 is the "schlieren," or slit grating, the heart of the optical system.

The grating bars of item 5 are silvered on the side that faces the arc lamp. Light from the arc is focused upon the entire area of the grating. That light which passes between the bars is lost forever. (This corresponds roughly to the shutter light-loss of a motion-picture projector). The light that strikes the silvered bar surfaces is deflected downward to the Eidophor liquid on the surface of the spherical mirror.

Wherever that liquid is unruffled by the electron bombardment the optical effect is as if there were no liquid there; the light is reflected from the mirror surface back to the schlieren bars, and from them back to the arc. But wherever the liquid is disturbed this light-path is altered, so that a portion of the light does not touch the mirror bars on its return path but passes between them to the projection lens (item 10). By this lens and directing mirror (item 11), the TV image is projected to the screen.

### Advantages and Otherwise

Some technical advantages and disadvantages of the Eidophor system of theater television, as contrasted with other large-screen systems now on the market or proposed, include the following:

Unlimited illumination, at least within the capabilities of modern projection arc lamps, which are enormous. In the demonstration system, the arc burned 125 amperes, or perhaps 6 kw. But the electron power in the cathode-ray beam was only  $20 \text{ kv} \times 20 \mu\text{a}$ , or 0.4 watt. This is an amplification of 15,000. Ten times greater amplification is possibly available, since Dr. Edgar Gretener, who built the demonstration arc and otherwise collaborated in the development of Eidophor, reports in the *Journal of the Society of Motion Picture and Television Engineers* for October, 1950, that he has developed an experimental lamp of similar design burning 63 kw—and producing a light output of 5 million lumens. No other system of direct projection theater-size television (except Skiatron, which is not on the market and may never be) uses the electric arc as its source of illumination. Film-intermediate systems—in which the face of a TV picture tube is photographed onto motion picture film, which is then automatically developed in a few seconds and projected like any other film—do so.

A second advantage of Eidophor is its unlimited projection "throw"—distance from projector to screen. Projection lenses are available for theaters and drive-ins of all sizes. But theater TV systems that utilize direct projection from the face of a picture tube to the theater screen are not now equipped with projection lenses but with the more efficient Schmidt optical systems. Their designers compensate for relatively limited light output by building in the

maximum obtainable efficiency in optics. However, owing to the present limited market for theater TV equipment, Schmidt systems are not yet available for throws of all lengths, and the projector unit must in consequence be located in some theaters, outside the projection room, where it is not readily available for attention and servicing. (Film-intermediate systems, of course, have arc lamps and motion-picture projectors and standard projection lenses, and are not limited as to throw.)

A third advantage of Eidophor (in the opinion of this writer) is its image quality. This is truly good; it does approach the quality of a Technicolor motion picture. Although standard 525-line interlaced scanning is used, the scanning lines are seldom visible; the image usually does not appear to have any horizontal "grain" at all. Mr. Sponable, when questioned, attributed this to a high degree of perfection in the interlacing. Faults not known in other TV systems can, however, cause trouble in Eidophor, notably, dust. Since the maximum amplitude of the deformations of the liquid surface, on which the image depends, is not more than a few thousandths millimeter, particles of dust too small to be seen by the naked eye can impair or even ruin the image if permitted to drift into the liquid. Such tiny, invisible particles are not always easy to keep out; particularly when the equipment must be opened in the theater for emergency repairs.

Among the drawbacks of Eidophor, as compared with direct-projection theater TV systems, is its complexity. It requires a vacuum pump and refrigerating apparatus in addition to normal television apparatus items; and it uses oil, which must occasionally be replenished. Eidophor is the most complex and elaborate of all direct-projection systems, not excepting the currently non-existent Skiatron. It is not, however, particularly more complex than film-intermediate systems; perhaps somewhat less so.

In its present form, Eidophor cannot give a continuous performance, since the arc carbons burn away and must be replaced. The same is true in projecting ordinary motion pictures, but does not matter in that case because the film runs out and must be replaced by a new reel. Theaters, therefore, always have two projectors, changing from one to the other as each reel is exhausted, and carbons are replaced at the same time as the film. Eidophor uses no film, and therefore has no need for two projectors, except to replace the carbons. For this purpose a modification of a military magazine-fed carbon arc is being developed for Eidophor. This is expected to permit continuous operation for from four to five hours.

An order for 500 Eidophor installations for theaters all over the United States is in process of negotiation between 20th Century-Fox and General Electric Company, President Spyros Skouras told his guests at the New York demonstration. END

# PICTURE

Of all the circuit checks involved in testing a modern TV receiver, few can match the picture tube from the standpoint of annoyance and sheer aggravation. Although the wires are right in front of you, there is no way to get at them with your test prods. Of course, you can always remove the socket, but this will not give you readings under load, nor will it show whether or not the picture-tube filament is good. These voltages must be checked, especially when the trouble is one of those no-picture, no-raster deals.

With this thought in mind, we went back about twenty years to find a solu-

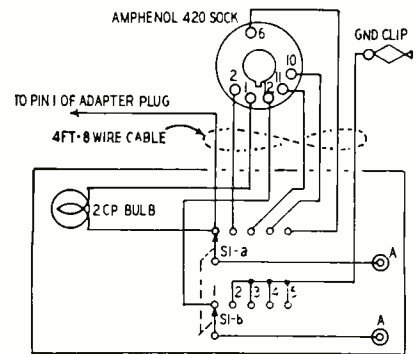

Fig. 1—Socket and selector schematic.

tion. Years ago, when you could count the number of tube types on your fingers, most analyzers came complete with adapter plugs. A plug was inserted in the tube socket of the set, the tube was placed in the adapter, and socket voltages were checked while the tube was functioning. This caused distortion and detuning in some circuits, but at least the set was operating and supply voltages were not affected.

Seeking a new twist for the old pretzel, we set about devising a quick, cheap, and efficient means of checking picture-tube voltages under operating conditions. This little device may be as simple or as elaborate as you care to make it; will tell at a glance if the filament is O.K., will measure filament, cathode, first-anode, and grid voltages (bias and signal), as well as focus-anode voltage of electrostatic-focus tubes. It does not interfere with normal operation of the picture tube. This convenience can be yours for an outlay of as little as five dollars.

For the basic instrument you will need an Amphenol 402 socket, a five- or six-pin duodecal base from a defunct picture tube, about four feet of 8-conductor cable, a 2-pole, 5-position switch such as a Mallory 173C, two pin jacks, a 2-contact automotive-type lamp socket, and a 2-candlepower automotive-type bulb. The bulb will show filament



# TUBE ANALYZER

By H. L. MATSINGER

continuity and is far cheaper than a 0-1 a.c. ammeter.

## Adapter plug and analyzer

A quick glance at Fig. 1 should give you a good idea of what we are trying to do. If you don't have a base from an electrostatic-focus tube, you will have to insert pin 6 in a standard 5-pin base. This is not much of a task. Drill a hole in the base in the pin 6 position, and cement in the extra pin.

Strip back the outer sheath at one end of the 8-conductor cable for a distance of about 8 inches. Then cut *all but one* of the exposed wires to a length of 2 inches. The long wire is used for a ground, and is fitted with a small alligator clip. Next, strip back the insulation on the seven remaining leads for about  $\frac{1}{2}$  inch, and tin them carefully. Now cut five pieces of No. 16 bus about 2 inches in length. If the cement in the base is dry and hard, cut off the tubular part with a hack-saw, leaving only the pin wafer and key, and make certain that the pins are not blocked by cement or solder.

Next, take the Amphenol socket, and solder a length of bus and one wire of the cable to terminals 2, 6, 10, 11, and 12. This should leave two unused wires. Solder one of these wires to the No. 1 pin of the socket. Nest all soldered wires in the channels of the socket, and align the bus leads from the socket with the corresponding pins of the plug. In-

be mounted on the panel near the switch. The panel may be  $\frac{1}{8}$ - or  $\frac{1}{4}$ -inch tempered Masonite. If the whole business is mounted in a small box made of  $\frac{1}{4}$ -inch plywood, you will have a neat looking job. Use pin jacks for terminals A-A.

## Using the analyzer

Insert the adapter between the receiver socket and the base of the picture tube, and connect the voltmeter to pin jacks A-A. With the analyzer switch in position 1, the bulb should light and the meter should show about 6 volts a.c. if the picture-tube filament is good. Positions 2 and 3 (grid and cathode, respectively) may show d.c.

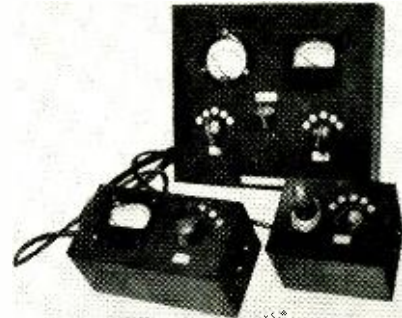

Two models of the analyzer-voltmeter. Large unit has filament a.c. ammeter.

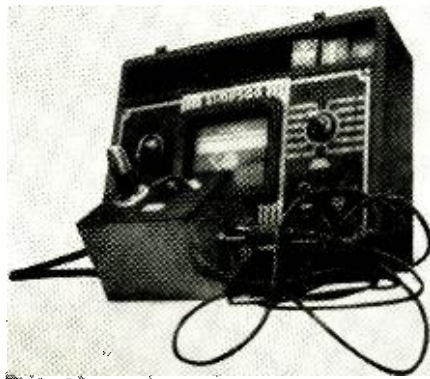

Selector with commercial voltmeter.

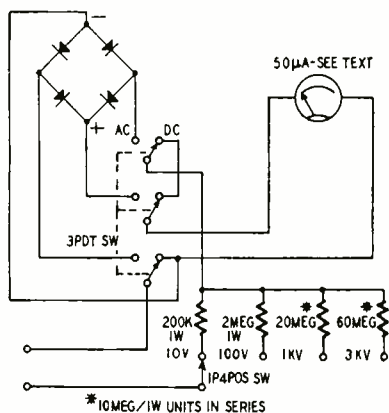

Fig. 2—Circuit of companion voltmeter.

sert the remaining free wire in the No. 1 pin of the plug and put each bus lead in its proper pin. Work the plug over the leads gently until it meets the socket firmly; then lock it in place temporarily by crimping over the No. 6 and No. 12 bus wires. Apply polystyrene dope generously around the base and socket. When dry, solder the bus and wire leads to the ends of the plug pins and trim off any excess.

Mount the 2-pole, 5-position switch on a panel, and wire it up as shown in Fig. 1. The automotive-lamp socket should

voltages anywhere from  $\pm 1$  to  $\pm 150$ , depending on the method used to feed the video signal to the picture tube and on the circuit location of the brightness control. (Before checking voltages in these positions refer to the receiver schematic and voltage charts. The important factor is the voltage relation *between position 2 and position 3*. Position 2 (grid) should always be negative to position 3 (cathode), and the difference should *increase* smoothly as the brightness control is turned toward *minimum* brightness.—Editor)

When a signal is present there should also be a fairly high a.c. voltage on the pin receiving the video input, which can be varied with the fine-tuning control or by changing the position of the antenna. This makes it possible to use the voltmeter for orienting antennas. With enough 2-conductor cable the meter can be taken to the roof and the antenna system can be adjusted for maximum signal (a.c.) voltage.

Position 4 (the first anode or accelerator grid) should show between 200 and about 475 volts d.c., depending on the circuit and the size of the picture tube. Position 5 is used only with electrostatic-focus tubes. Low-voltage-focus

types will read 0 to 500 volts, while high-voltage-focus types may have as much as 3,000 volts. With either type, the voltage should vary smoothly as the focus control is adjusted.

Note: High-voltage-focus types are generally supplied from the flyback circuit through a separate rectifier and very-high-resistance voltage divider. Your voltmeter must have higher input resistance than the divider to avoid loading the circuit and reducing the voltage. Only a v.t.v.m. or a 20,000-ohms-per-volt meter with a suitable high-voltage range should be used.

## Voltmeter unit

In the event that you decide to build a voltmeter to go with the analyzer, use the circuit shown in Fig. 2. By housing the meter in a separate case, and making connections to the switch box with banana plugs, you can take the meter to the roof for orienting the antenna.

The multiplier resistors should have the highest possible accuracy. The rectifier is a standard full-wave-bridge instrument type obtainable from most supply houses.

However elaborate or simple you decide to build your analyzer, you will find it of great value in speeding your trouble-shooting, and you will probably find even more uses for it than I have.

## Materials for analyzer

**Miscellaneous:** 1 Amphenol type 420 duodecal socket or equivalent; 1—2-pole, 5-position switch (Mallory type 173C or equivalent); 1—2-contact automotive type lamp socket; 1—2-candle-power automotive type lamp; 2 pin jacks; 4 feet of 8-conductor cable; panel; cabinet; bus bar; alligator clip; hardware; solder.

## Materials for voltmeter

**Resistors:** 1—200,000 ohms, 1—2 megohms; 8—10 megohms, 1 watt,  $\pm 1\%$ .  
**Miscellaneous:** 1—0-50 d.c. microammeter; 1 full-wave-bridge instrument rectifier to match microammeter; 1—3-pole, 2-position switch; 1—single-pole, 4-position switch; panel; cabinet; hardware; wire; solder.

END

# HIGH VOLTAGE SERVICE HINTS

By H. LEEPER

**M**OST of us enjoy seeing our names in print—but nobody wants to be featured in the obituary column. Every so often a nasty reminder comes along that service technicians—even the most experienced ones—are not shockproof. The most recent of these was the death of a Chicago technician—electrocuted by the h.v. circuit of a television receiver. (See RADIO-ELECTRONICS for September, 1952, page 90.)

In spite of the obvious hazards of high-voltage circuits, a far greater number of fatalities are caused by contact with that little old 117-volt line which many of us regard with such contempt. And the B supply circuits of modern TV receivers—with their extra-high-capacitance electrolytics—can store more death-dealing energy than any present-day h.v. supply.

Remember, *it takes less than 150 ma to kill a normal, healthy human being.* A quick look at Ohm's law ( $E=IR$ ) will show you that very little voltage is required to push that current through your body if its resistance is low enough.

Keep your body resistance as high as possible, and avoid *any contact* with the live circuits of a receiver. At times, unfortunately, many of us forget the fact that the live circuits may include the chassis, or *any grounded object* (even the floor).

Every service shop should have a wooden floor. Where work must be done in homes or other locations with cement floors, insulate yourself from the floor with rubber mats. These mats are about 12 x 21 inches and are obtainable at any auto or department stores—inexpensively. (Photo A)

Dry boards may be used for the same purpose. A few 1-inch-thick boards about 10 x 60 inches will provide a safe working platform. They should be stood on end to dry when not in use.

When testing or repairing equipment near water pipes, radiators, steam pipes or grounded electrical conduits and switches, wood or masonite boards provide the necessary margin of safety. (Photo B)

A long, dry, wood stick or plastic rod is the best tool for probing around wiring near the picture tube or other live parts. (Photo C)

Where line-interlock switches must be held in the closed position with the receiver back off a wood tongue depressor is a lot safer than a screwdriver. Even if you're using only one hand inside the cabinet you might come in contact with the blade. (Photo D)

Always hold a high-voltage probe so that the guard ring is between your hand and the high voltage. *Keep your hand closed and away from the probe lead.* (Photo E)

Don't depend on the wire insulation to protect you if the internal multiplier resistor should break down or arc over.

High-voltage probes are easier to carry, store, and keep dry, if they are taken apart. With the probe dismantled the multiplier resistor should be kept in a toothbrush container lined with soft, dry cloth. A small zipper bag is an ideal carrying case. (Photo F)

The outside of the probe should always be wiped dry before and after use. Moisture inside the probe can be removed with a narrow bottle brush.

Wearing goggles while handling picture tubes is a common-sense precaution repeatedly emphasized by the tube manufacturers themselves. *They should know.* Still, many technicians refuse to wear them, especially if they already wear glasses. These impact-resistant goggles weigh only about 3 ounces and can be worn comfortably even over ordinary eyeglasses. They give unobstructed vision and cover considerably more of the face than the usual type. (Photo G)

Some picture tubes rest loosely on the metal chassis when the set is removed from the cabinet. An old bicycle inner tube makes a handy protective bandage. The ends of the inner tube can be anchored to the chassis to hold the picture tube firmly and safely in position. (Photo H) END

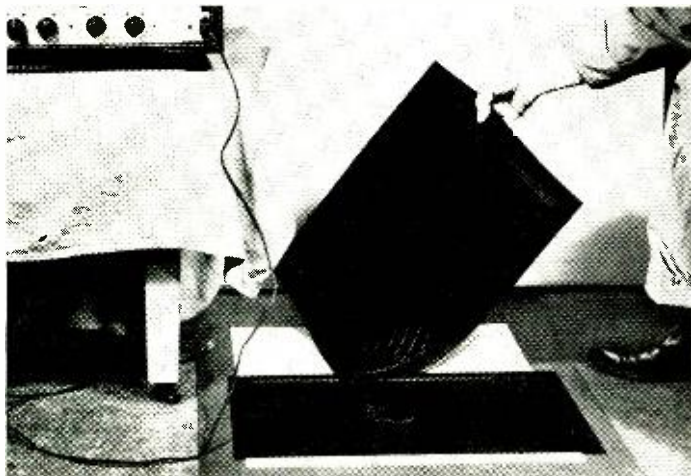

A



B



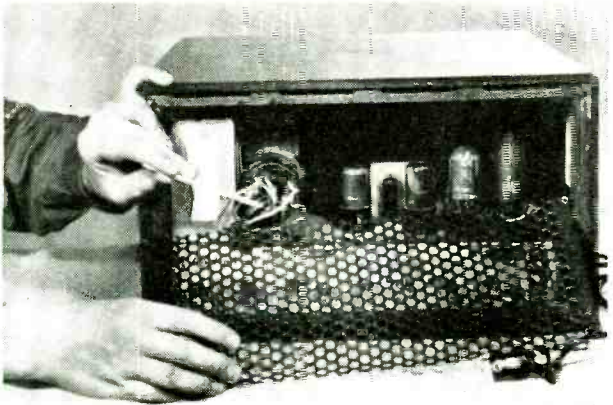

(C)

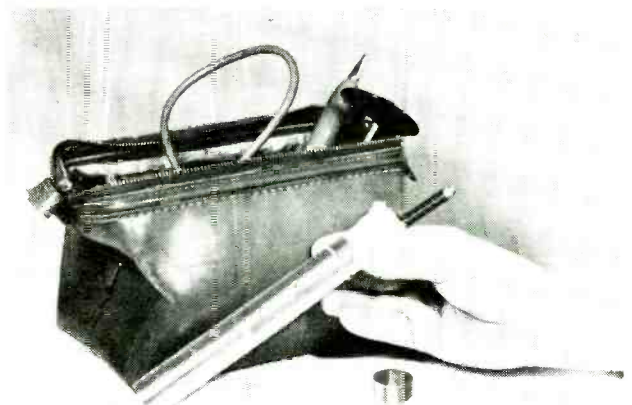

(F)

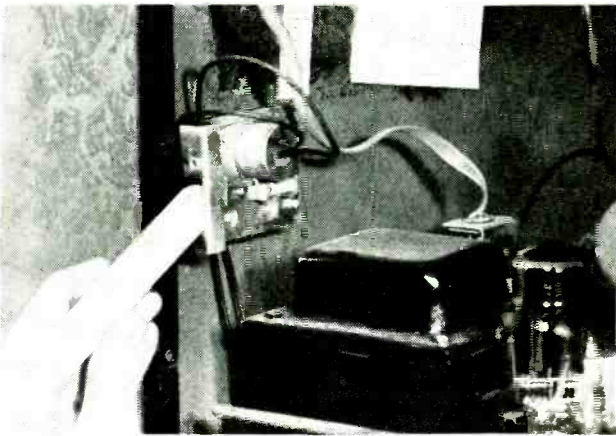

(D)

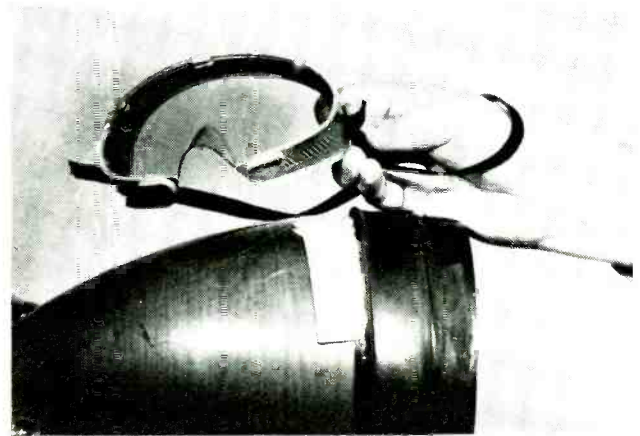

(G)

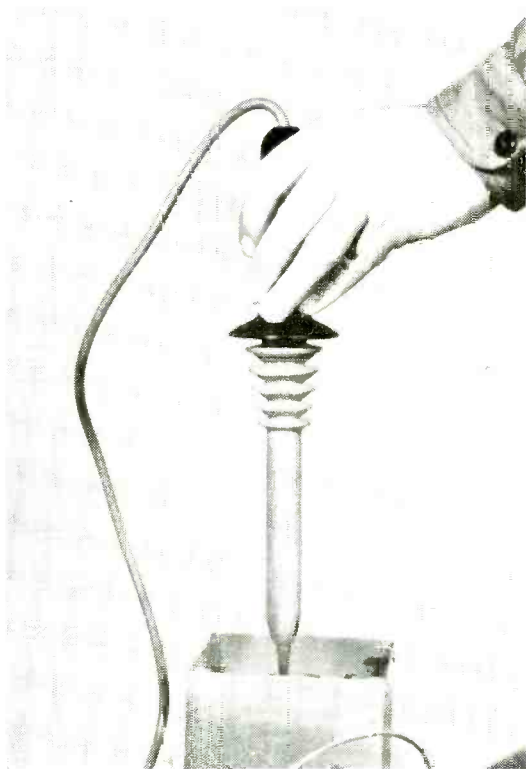

(E)

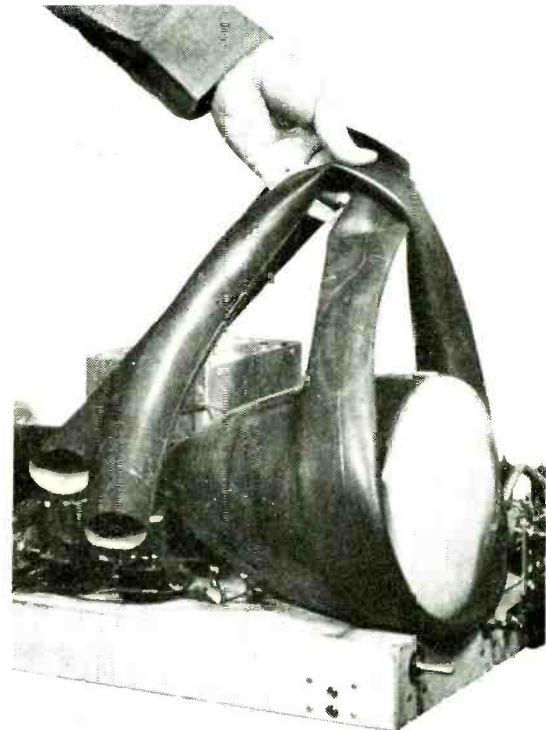

(H)

BY JOHN B. LEDBETTER\*

# ELIMINATING THOSE NUISANCE

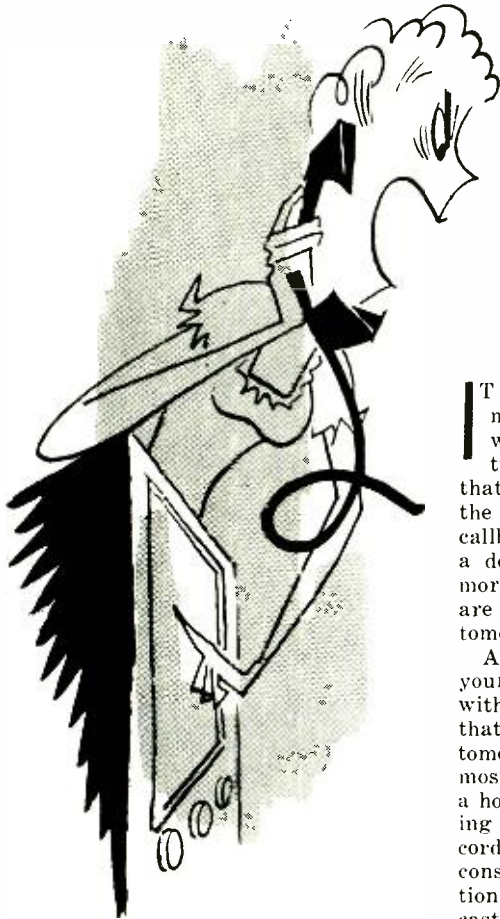

IT HAS been said in the past that the major cause of nuisance service calls was lack of proper customer education. The author would like to say that lack of customer education is *still* the number one cause of profit-wasting callbacks. Callbacks not only represent a definite loss of profit to *you*, but—more important in the long run—they are a prime cause of dissatisfied customers.

After installing set after set, you yourself may have become so familiar with their operation and adjustment that a detailed explanation to the customer seems unnecessary. However, in most cases your customer is going to be a housewife who knows absolutely nothing about operating a TV set, and (according to her husband) usually has considerable difficulty in tuning a station properly on her \$9.95 AM broadcast receiver.

### Basic psychology

The following steps are very important in educating your new customer. Properly used, they will increase

\* Engineer, WKRC-TV

your list of satisfied customers and practically eliminate needless complaints.

1. Your first step, whether installing the set or servicing it, is to gain the customer's confidence and respect. Do this by appearing in neat, clean clothes and by using professional courtesy.

2. Ask the customer where *she* would like the set. If her choice is impractical or impossible, make the proper suggestions *tactfully* and *explain why* another location is better or necessary.

3. If you must use tools inside the house, lay them out *neatly* on a drop-cloth. Keep the solder and soldering iron where there is no chance of burning or scratching the rug, floor, or furniture.

### Proper customer instruction

1. When installing the set, go over all preset and rear-chassis adjustments carefully and note if any of these controls can be operated accidentally while housecleaning or moving the set. If any can, explain this possibility to the customer and *show* her the location of the control.

2. When the set has been installed and adjusted, give the customer a careful, simplified explanation of the tuning adjustments—*not* a fast run-down of each control's function, but a detailed, step-by-step explanation. Then ask the customer to try tuning the set herself, and explain the operation again as she goes through each step. Have her repeat the tuning adjustments several times until you are sure she is thoroughly familiar with the procedure.





# SERVICE CALLS

3. Explain briefly how variations in weather or foliage in nearby trees can affect reception; and how poor films, incorrect lighting, or equipment troubles at the station can affect the quality of the picture. If the customer understands these possibilities she will be more tolerant of temporary troubles and less likely to call you for minor adjustments.

4. When explaining variations such as those just mentioned, be sure the customer realizes you are giving her useful information and not trying to alibi your way out of future servicing obligations.

5. If the focus control is accessible or can be moved accidentally, show her how to adjust it for the sharpest scanning lines, and have her adjust it once or twice.

6. Improper adjustment of the horizontal hold control is a frequent cause of nuisance complaints. Explain why this control should always be set in the middle of its range; show her how a proper adjustment on one station might

she use it regularly as a guide for obtaining the best possible picture. (Have your name, shop address, and telephone number stamped on the outside and inside of the booklet, as well as on the back of the set cabinet.)

9. If the instruction booklet does not contain full operating instructions, or if the booklet is missing, you might leave your own list of instructions. A mimeographed list costs next to nothing and is one way of showing your customer that you have a personal interest in her purchase. A typical list might follow the outline in the box below.

There may be times when your "install-and-run" competitor seems to be making installations faster than you. Rest assured that conscientious, well-organized installations, with proper customer instruction, will keep you busy with *new* customers while your not-so-considerate friend is making good on nuisance call-backs or creating dissatisfied customers by failing to make good on those calls. END



not be the best on another. Also caution against using the horizontal hold control to center the picture. (Many customers do this if the picture is slightly off-center and then fail to understand why horizontal sync is so critical or will not hold in.)

7. If the installation requires antenna switching, a beam rotator, or (in many city homes) an indoor antenna, find the best position for each channel, and make a small chart, if necessary, to help the customer find them again.

8. After you have explained the various operations and your customer is satisfied with the picture, leave the instruction book with her. Suggest that

## HOW TO TUNE YOUR SET FOR THE BEST PICTURE:

1. Turn the set on, turn the volume control about halfway up, and allow about 1 minute for warmup.
2. If your set is a combination model (AM-FM-TV-phono), see that the OPERATE switch is in the TV position.
3. Turn the station-selector switch or tuning control to the desired channel.
4. Adjust the fine-tuning control (if your set has one) for the best sound. Readjust the volume control if necessary for the desired volume. Do NOT regulate volume by turning the fine-tuning control back and forth.
5. Turn the brightness up until slanting white lines appear, then decrease it slightly until they just disappear. (This step may be omitted if the set has vertical-retrace blanking.—EDITOR)
6. Adjust the horizontal hold control (if necessary) until the picture locks in horizontally. Switch to another station to make sure it locks in on all channels. Readjust if necessary.
7. Adjust the vertical hold control if the picture is moving up or down.
8. Set the contrast (picture) control for the most natural shading. Readjust the brightness for the most pleasing picture.
9. Adjust the focus control (if necessary) for the sharpest picture. (Look at the fine black lines on your screen and adjust focus until these lines are the sharpest.)

### NOTES:

Do not use the horizontal hold control to center your picture. If it is seriously off-center, call our shop for readjustment.

If your picture or sound is poor, see that the two wires going from your set to the antenna are still connected.

If you have troubles which cannot be corrected by carefully readjusting your tuning controls, call the TV Service at .  
We'll be happy to serve you.

# TV SERVICE CLINIC

Conducted By  
**MATTHEW MANDL\***

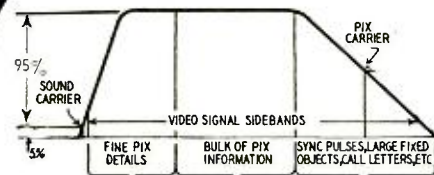

Fig. 1—Ideal i.f. response curve for intercarrier-type television receivers.

**Q** UERIES from readers often include the following:  
When does i.f. misalignment affect sync?

What quick check will show if alignment is needed?

Manufacturers recommend the picture carrier be set 50% to 60% down on the response curve. Which should it be?

Because these are important points for the servicing technician, it might be well to re-emphasize factors governing bandpass requirements in video i.f. stages. Fig. 1 shows a typical i.f. response curve for *intercarrier* receivers. The sound carrier is set 95% down to give proper heterodyning at the video detector and minimize intercarrier buzz. The picture carrier should not be down more than 60% on the response curve. The reason for this, aside from vestigial sideband correction, concerns the signal sidebands. The vertical lines in Fig. 1 illustrate sideband components. The group marked "A" are close to the picture carrier and represent the *low-frequency video-signal* components. The group marked "B" are the middle-frequency video components, while the portion indicated by "C" are the high-frequency picture signals.

When the picture carrier is more than 60% down the slope the "A" sidebands (which contain the low-frequency sync pulses) will be weakened. This will cause pulling or weaving if their amplitude is decreased slightly, or sync instability if they are diminished too much. Picture quality will suffer too. Fig. 2 shows the effect of poor low-frequency response. Note that the horizontal wedge is not as dark as the vertical wedge. (This has nothing to do with focus, for the horizontal wedge detail is clear.) Large fixed objects—representing relatively low-frequency signal components—will be fuzzy and may have trailing smears. Keeping the carrier in the 50% to 60% region of the response curve assures adequate low-frequency response and good sync stability. Setting the carrier higher than this is not recommended because low-

\* Author of *Mandl's Television Servicing*

frequency components will have excessive amplification. The 50% setting will not accent low frequency components too much, and will assure better stability, particularly in fringe areas.

If the top of the response curve is not flat, similar troubles may occur. If the response curve has an abnormal drop around the high-frequency signal components represented by "C" in Fig. 1, fine detail will suffer. This loss of high-frequency signal information would obscure the vertical wedge as shown in Fig. 3. This will have little effect on sync, but the picture will not be as sharp as it should be.

Resonant humps will have the same effect. A sharp rise in the response curve around the low-frequency picture sidebands overaccents low-frequency response and the high-frequency video signals will be down by comparison. If the response curve is humped around the "C" sidebands high-frequency signal components are accented. This can cause transient oscillations in the video amplifier and repeat lines at the sharp edges of objects shown on the screen.

Similar requirements also apply to tuner alignment and tracking, for the shape of the tuner response curve affects sync and picture detail in identical fashion.

A quick check of receiver performance can be made by studying a station pattern and comparing the clarity of the vertical and horizontal wedges. Additional checks and corrections can be made with a sweep generator with flat output, an accurately calibrated marker, and an oscilloscope.

Marker accuracy is extremely important because an inaccurate marker results in misalignment and will *produce* instead of eliminate the faults above.

### Width control failure

*On a Westinghouse H-251 receiver the width control keeps burning out. The receiver is now in use because I substituted a high-wattage fixed 1,500-ohm resistor, but this impairs horizontal linearity. Current through the resistor*

*is 65 milliamperes. All tube voltages check normal and all waveshapes are as indicated in the service notes except at the grids of the 7A5 parallel output tubes. Here, the waveform is slightly distorted from that shown on the schematic. What can be done to reduce the width control current so I can replace the potentiometer? —S. S., Santa Clara, Calif.*

A common cause of this trouble is failure to maintain the critical drive voltage required for the parallel 7A5 tubes. The cathode resistor R-467 does not provide enough bias for the 7A5's if the horizontal multivibrator drifts or the drive changes. (Fig. 4.)

Adjust the ringing coil for best horizontal-sweep stability and try slightly different values for the peaking components R-474 and C-427. You will have to determine the exact values experimentally so the grid-drive signal has the exact shape shown in the schematic. You can also increase cathode resistor R-467 to 200 ohms. These changes will decrease the current through the 7A5 tubes and reduce the wattage dissipated in the width-control potentiometer.

### G-E production changes

*In a General Electric model 12C107 I am encountering horizontal instability. The voltage and resistance measurements are virtually as called for on the manufacturer's schematic and I have replaced all tubes. The horizontal hold control is very touchy and holds sync only for a short time. Rear-panel controls don't help.—J. C., Bronx, N. Y.*

This trouble is probably caused by one of several components which were found to contribute to instability and were changed in later production models of this receiver.

One improvement consisted of changing R-379 from 180,000 ohms to 270,000 ohms, ½ watt. (Fig. 5.) This resistor is in the bias-supply circuit feeding the a.f.c. control tube. Also check the 6-μf capacitor (C-369) between the horizontal deflection coils and the 19BG6-G grid network. Its value



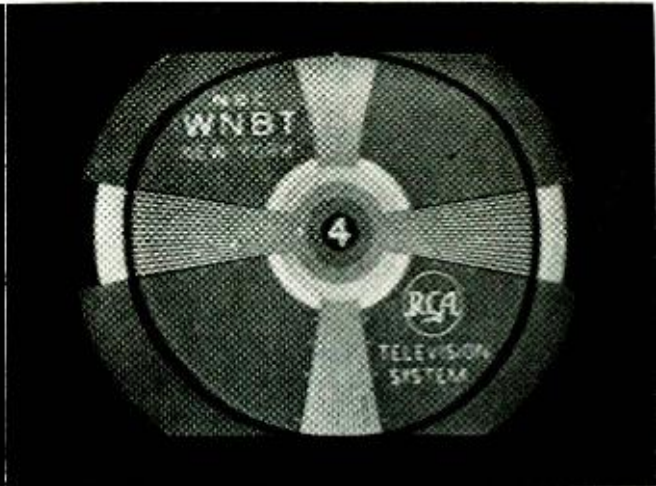
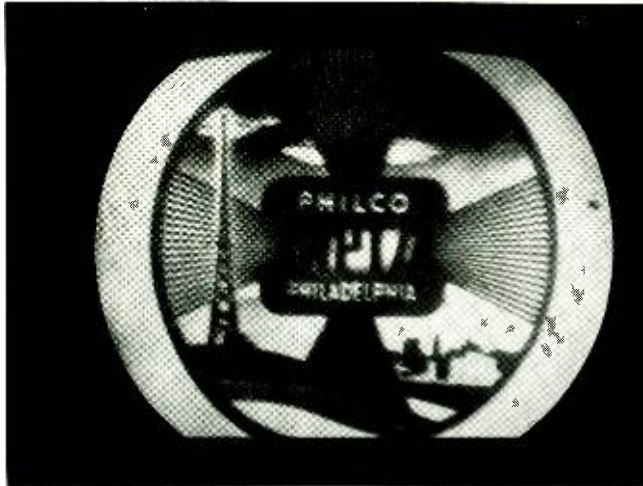

Fig. 2 (above left)—Poor l.f. response.  
Fig. 3—(above right)—Poor h.f. response.

sometimes increases by 100  $\mu\text{f}$  or more, starting oscillation in the output stage. This causes severe sweep instability. Substitute a capacitor with higher voltage rating (Part No. RCU-300:6- $\mu\text{f}$ , 1,500-volt mica capacitor).

**Intermittent centering**

In a Sonora, Series B, model 700-ATV, there is an intermittent shift of the picture along a horizontal plane. This does not occur until the set has been operating about ten minutes and finally clears itself after about 40 minutes of operation. What causes this?—J. W., Clarksville, Tenn.

This indicates an unstable d.c. idling voltage in the horizontal deflection coils. This could be caused by a defective component in the low-voltage power supply or by a defective horizontal coil section in the yoke. This receiver has an elaborate low-voltage bleeder system for distributing various potentials to the circuits. Check: all resistors and capacitors in the bleeder system and throughout the low-voltage power supply. Changes in any of these during warmup will affect the idling voltage and shift the position of the picture. This trouble would not be caused by changes in sweep amplitude (which would affect width).

A voltmeter across the output of the power supply will show any voltage change during warmup. The voltage is normally higher at first and drops during warmup but the decline should be gradual and not fluctuating.

**Drive setting**

I am having some horizontal linearity difficulty as well as excessive current and overheating in the horizontal output system. I would appreciate an explanation regarding what effect the drive control has on such conditions.—A. M., Tiffin, Ohio.

The drive to the grid of the horizontal output tube can have considerable effect on performance. Insufficient drive will decrease high voltage as well as width. It will also increase the d.c. idling current through the tube by reducing the bias. Overdrive will cause

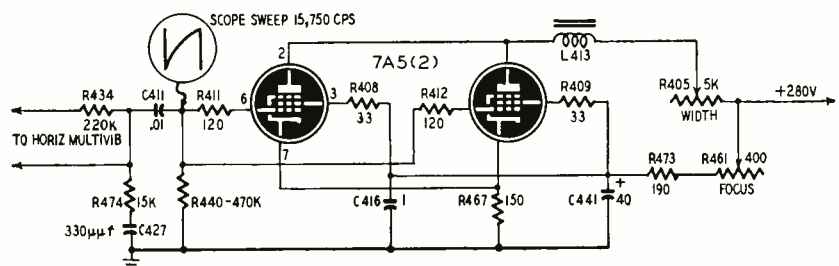

Fig. 4—Horizontal output stage of Westinghouse model H-251. Drive is critical.

excessive signal currents through the tube. Either condition may overheat the tube and associated parts. Overdrive may stretch the left side of the picture and compress the center. The correct setting for the drive control is just below the point where left-hand stretch starts. A slightly gassy horizontal output tube will also cause overheating of parts.

**Vertical linearity defects**

In an Olympic model 766-U (752) receiver the scanning lines at the top and bottom are not as widely spaced as at the center. Neither the height or linearity controls will correct this condition which has existed since the set was purchased. Best sound and picture cannot be obtained by adjustment of the oscillator slug or the fine-tuning control. Can this condition be corrected?—M. B., Pittsburgh, Pa.

For the vertical linearity defects you mentioned, the following changes (see Fig. 6) in this receiver are recommended by the manufacturer:

Change C47 (4  $\mu\text{f}$ ) to 20  $\mu\text{f}$ , 450 voltage-age.

Change R55 (3,300 ohms, 2 watts) to 1,000 ohms, 1 watt.

In the peaking network (R54, 3,300 ohms and C46, .05  $\mu\text{f}$ , 600 voltage) disconnect ground side of the network and connect to pin 6 of the 6SN7-GT vertical sweep tube.

Check the 6SN7-GT and try several different ones.

Note: It is important that if one of the four changes mentioned is made, that all be made.

This is not an intercarrier receiver, therefore tuning for the best sound may not always give the best picture. This is more noticeable in fringe areas. With

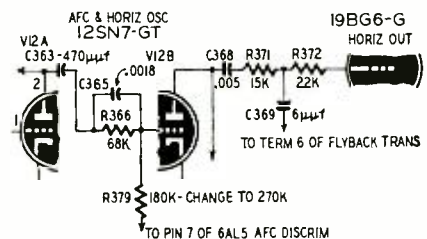
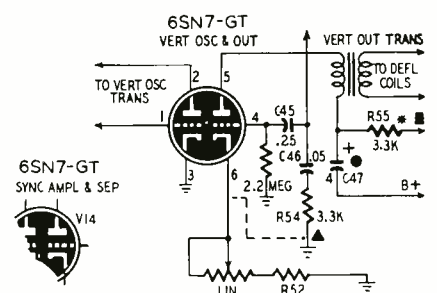

Fig. 5—Changes for improved horizontal oscillator stability in G-E model 12C 107.



▲ REMOVE CONN (GND) & CONNECT TO PIN 6  
● CHANGE TO 20 $\mu\text{f}$  \* CHANGE TO 1K/1W ■ TO BOOSTED B+

Fig. 6—Manufacturer's changes for better vertical linearity in Olympic 766-U.

proper alignment you should get a good picture at the best sound point.

Note: Letters sent to the Clinic are answered directly and only those of general interest are printed each month. There is no charge for this service to our readers. When writing, give the name, model number and chassis number of the receiver, and what tests and replacements have been made prior to writing us. Give full details of symptoms. (Letters reproduced here have been condensed because of space requirements.) Enclose a self-addressed, stamped envelope. END

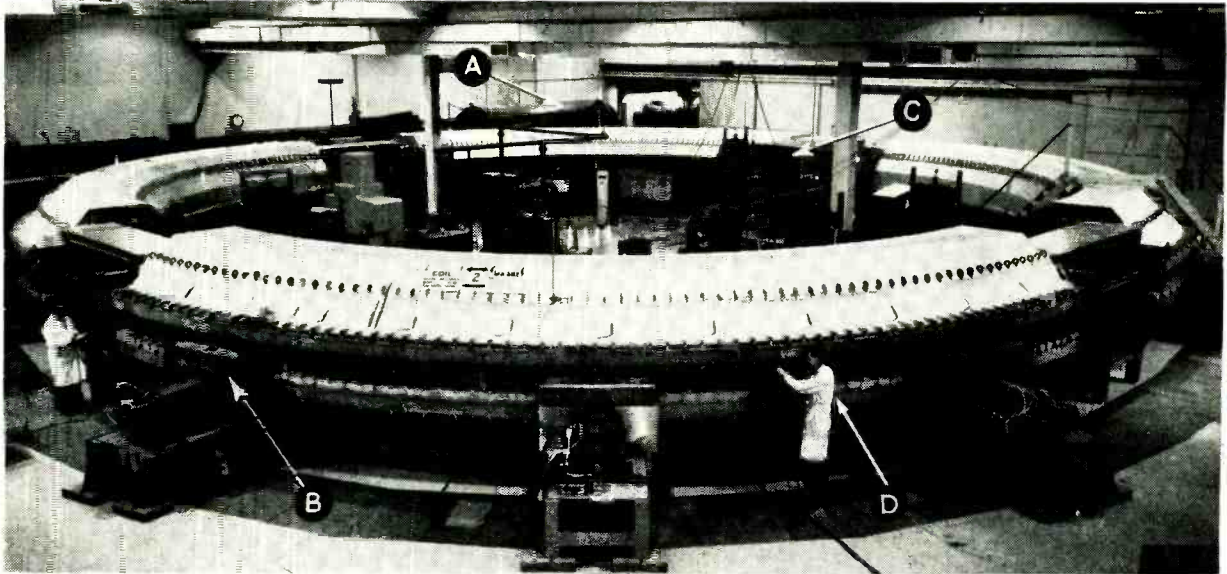

The Cosmotron at Brookhaven National Laboratory. Protons—positively-charged nuclear particles—circle the huge track at almost the speed of light, develop billions of volts of energy for non-secret atomic research. Labeled sections are shown in detail in the accompanying diagrams and photographs. In the foreground are three of the 12 oil-diffusion pumps that maintain vital vacuum in the stainless-steel tube. The technician at the right is at one of the “windows” where targets for bombardment are inserted in the raceway.

# COSMOTRON

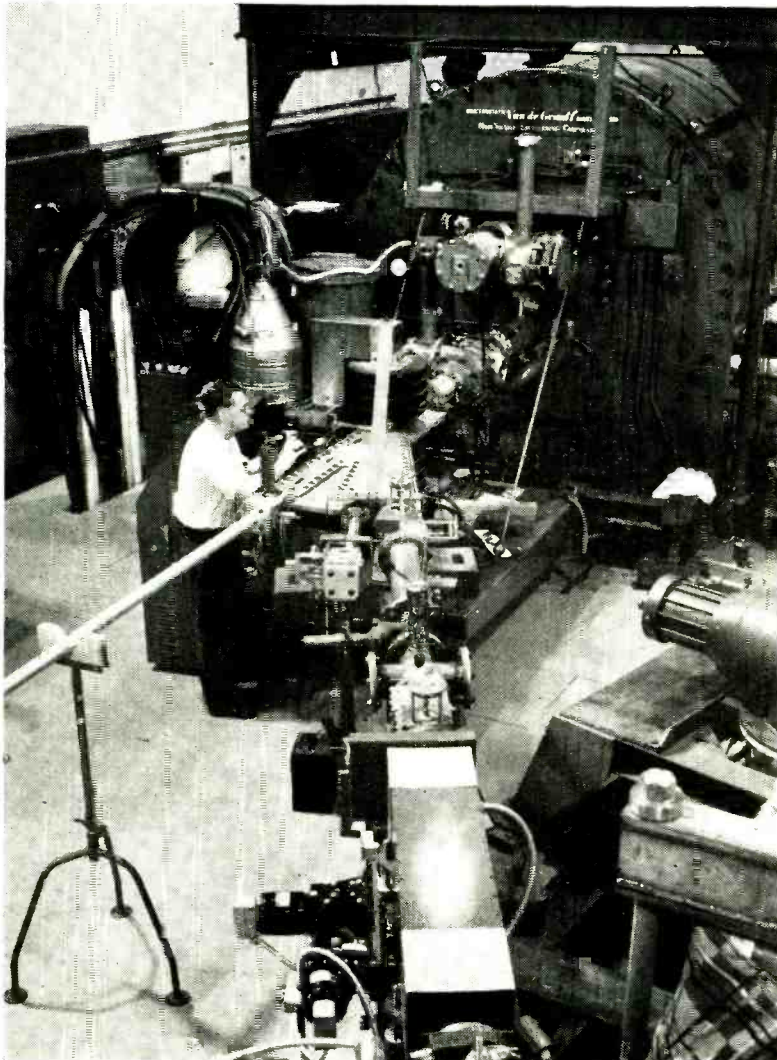

Three billion volts speeds particles to near speed of light

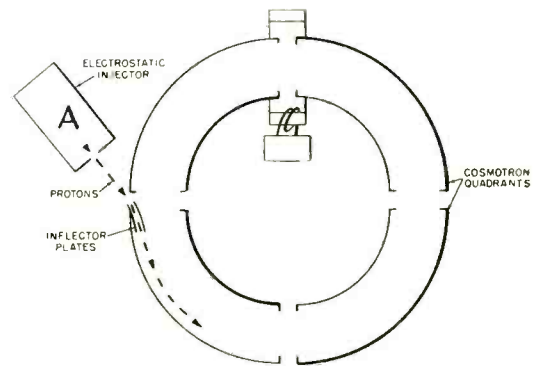

A

Proton source for the Cosmotron. Van de Graaff electrostatic high-voltage generator smashes hydrogen atoms, shoots protons and hydrogen ions at 3.6-million volt velocity down narrow tube at left for testing. When inverted L-shaped electro-magnet (center) is turned on, ions are deflected to center stub; lighter protons, deflected more, race through complex optical analyzers and rectangular inflector box to Cosmotron (lower right).



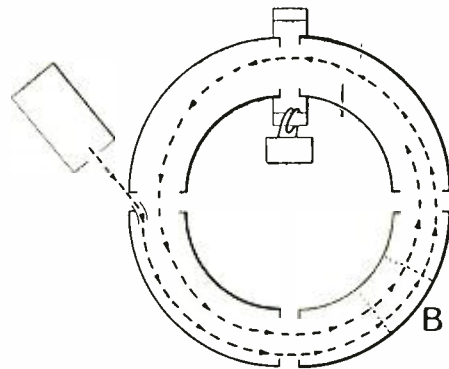
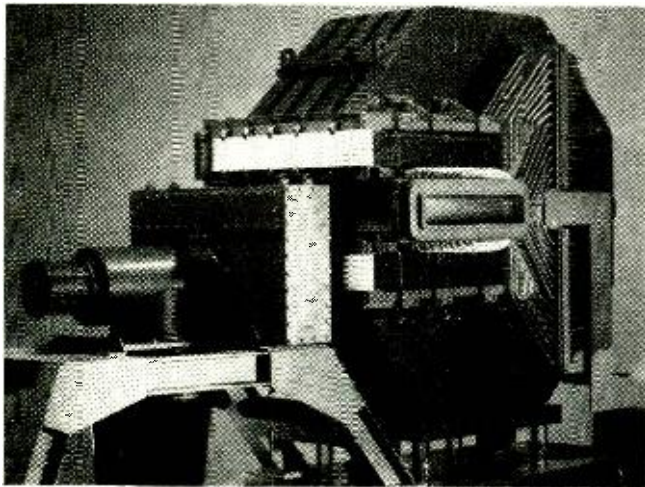

INCREASING MAGNETIC FIELD CAUSES PROTONS TO SPIRAL IN AROUND COSMOTRON MAKING 350,000 TURNS PER SECOND

**B**

Progressively stronger magnetic fields in four quadrants force protons to follow spiral path as they circle tube 350,000 times per second. Cross-section through Cosmotron at B shows stainless-steel proton tube at magnet center, continuous-evacuation pump at left. Octagonal core laminations are eight feet across. Windings are hollow copper bars filled with liquid coolant to remove heat of 7,000-ampere current.

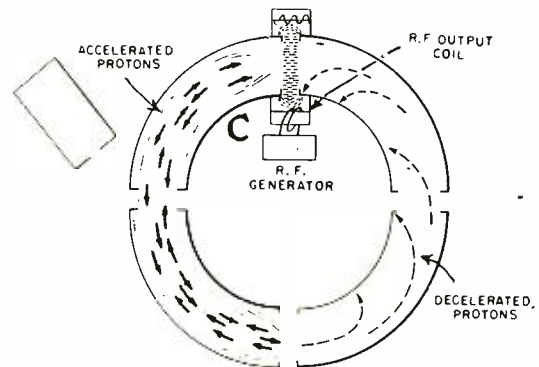
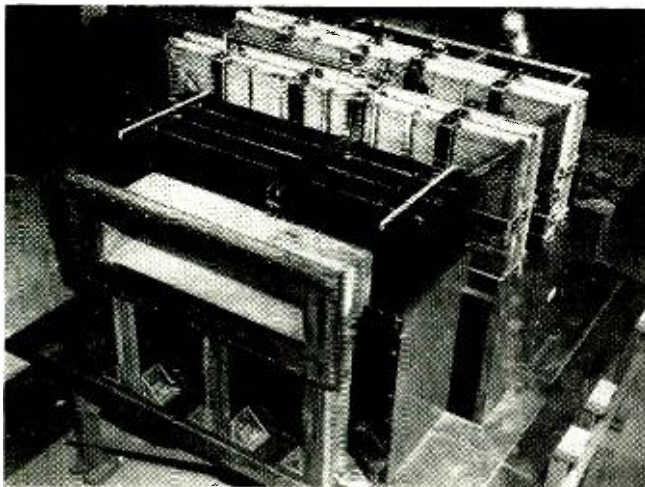

**C**

Turning on r.f. generator C gives whirling protons a 500-volt kick 4 million times a second. Protons approaching the field of the huge output coil are accelerated by negative half of r.f. cycle, decelerated by positive half. Slowed protons spiral inward, are absorbed by chamber walls. Speeded protons cluster, race faster and faster, reach billion-volt level in less than a second.

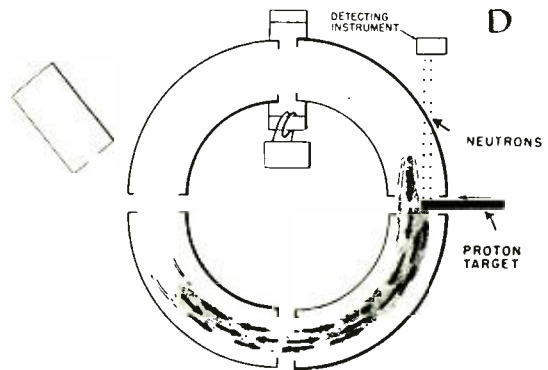

**D**

Protons at desired energy level strike a swiftly-inserted target, give up positive charges. Now neutrons unaffected by electric or magnetic fields, they continue in straight lines to detecting instruments outside the magnet. Photo shows Brookhaven scientists at the instant protons first passed billion-volt mark. Cosmotron later produced energy levels above 3 billion volts.

GEORGE FLETCHER COOPER

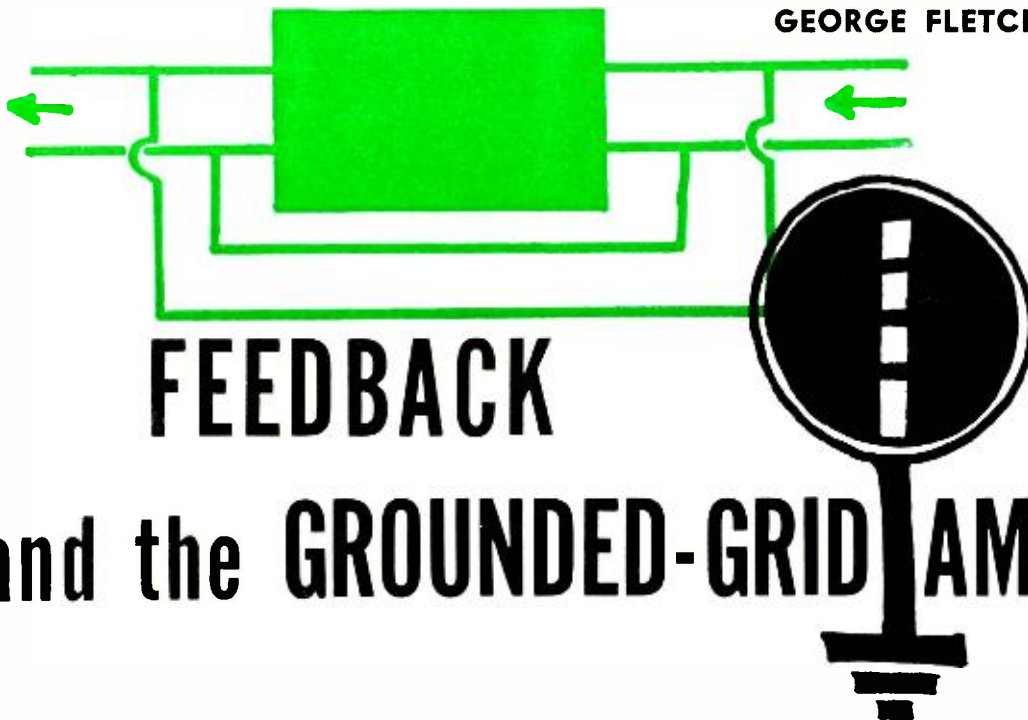

# and the GROUNDED-GRID AMPLIFIER

THE grounded-grid amplifier is familiar to designers who work at very high frequencies: it is used for the final stages of transmitters in the kilowatt class, and in some wideband low-noise-level amplifiers. The audio designers have ignored its potentialities, both in America, where they call it grounded grid, and in Britain, where they call it the inverted amplifier. A while ago I began to wonder about using grounded-grid stages in audio amplifiers, so I set my assistant to work, while I settled down and

"... wrote with a pen in each hand, and explained all the while in a popular style  
Which the reader could well understand."

The experimental work, which is still in progress, is being carried out with a 12AT7 double triode. This is not exactly a power tube: with plate supplies of 150 volts and a normal circuit you would not expect to get 100 milliwatts of power from one triode section. However, this happens to be just the sort of power I want for a particular amplifier. It gives me the opportunity to try out the grounded-grid stage with some feedback circuits which do not seem to be in the books. The reader who is interested can apply the theory to power amplifiers with the knowledge that he is on fairly new ground.

First of all, what is the grounded-grid amplifier? The basic circuit is shown in Fig. 1, where, as you can see, the input is applied between cathode and ground and the output is taken between plate and ground: the grid itself is connected directly to ground. Bias is provided in the usual way by the voltage drop in the cathode lead, and the input transformer can be dimensioned to provide the necessary secondary resistance. It is instructive to com-

pare the three ordinary ways of connecting a triode amplifier: grounded cathode, grounded grid, and grounded plate. These are drawn in Fig. 2. They are three of the six possible ways of using the triode. The complete set of six connections is shown symbolically in Fig. 3.

The three elements of the tube are shown as terminals, with signal being applied and output taken as indicated by the arrows. An inward pointing arrow is input, and one pointing out is output. Thus, at *a* the signal is applied between grid and cathode and the output taken off between plate and cathode, as at *a* in Fig. 2. Of these, *a*, *b*, and *c* are already shown in Fig. 2; *d* and *e* appear to be quite useless; and *f* has been used for measuring high voltages. Negative plate voltages control the grid current with the grid held positive, the tube having an amplification factor of  $1/\mu$ .

## Features of the circuit

The particular features of the grounded-grid amplifier, as we shall see, are low input impedance, normal output impedance, and the fact that the power which must be applied to the input is passed through the tube and mostly appears in the load. Let us see how these features are produced. The equivalent circuit is shown in Fig. 4: *e* is the input generator voltage, acting through an impedance  $R_i$ , which includes any cathode resistor,  $\mu$  and  $R_p$  are the usual tube parameters and  $R_L$  is the load resistance. The current through the circuit, *i*, is given by the equation  $i = e - \mu e_g / R_i + R_p + R_L$ .

Now  $e_g$  is the grid-cathode voltage, which is here equal to  $iR_i - e$ . Therefore  $e(1 + \mu) = i(1 + \mu R_i + R_p + R_L)$ . The output voltage is, of course,  $iR_L$ , so that the voltage gain,  $iR_L/e$ , is equal to

$$\frac{(1 + \mu) R_L}{R_i + R_p + (\mu + 1) R_L}$$

If you remember the expression for the gain of an ordinary grounded cathode amplifier,

$$m = \frac{\mu R_L}{R_p + R_L + (\mu + 1) R_L}$$

you will see that when there is no cathode impedance the grounded-grid stage gives the same voltage gain for a tube with an amplification factor  $\mu$ , as a grounded cathode stage with a tube of amplification factor  $1 + \mu$ . With a cathode resistor the term  $1 + \mu R$  appears in both cases.

The input impedance of the grounded grid stage is quite easy to calculate. It is, of course, just  $e/i$ , which is

$$R_i + \frac{R_p + R_L}{1 + \mu}$$

For the grounded cathode stage, as you know, the input impedance is theoretically infinite. This input impedance may be simplified a bit to give an approximate expression which is easier to remember. Since we always use triodes in grounded grid stages,  $R_L \approx R_p$ . We have then

$$R_{in} = R_i + \frac{2R_p}{1 + \mu} \approx R_i + 2 \frac{R_p}{\mu} \approx R_i + \frac{2}{g}$$

where  $g$  is the tube transconductance. For most of the tubes we are using nowadays  $g = 2,000 - 10,000 \mu\text{mhos}$ , so that  $1/g$  may be of the order of 250 ohms and  $R_{in} = R_i + 500$  ohms. Let us take  $R_i = 500$  ohms, and we have  $R_{in} = 1,000$  ohms.

For a small tube, a drive of 4 volts may be what is needed: the resulting power input is 16 milliwatts. This drives a current of 4 ma through the circuit, producing a power output in 10,000 ohms, again a typical value, of 160 milliwatts. If we scale up these figures, you see that a driver stage for a 16-watt grounded grid amplifier must deliver 1.6 watts: this is quite a contrast with the ordinary power stage which needs only a few milliwatts.

The output impedance is most easily calculated by remembering that if the



output is matched it will produce one-half the open-circuit voltage. Since the open-circuit gain, obtained by letting  $R_2 \rightarrow \infty$ , is  $1+\mu$ , the output impedance equals the value of  $R_2$  for which the gain

$$\frac{1+\mu R_2}{R_p+R_2+1+\mu R_1} = \frac{1+\mu}{2}$$

This gives for the output impedance the not unexpected value  $(R_p+1+\mu R_1)$ . Since the  $1+\mu R_1$  term is of the nature of a negative feedback the optimum load is not the matching load but the load settled by the tube characteristics and is about  $R_p$ .

Before we go any further let us summarize the results:

$$\text{gain} = \frac{(1+\mu) R_2}{R_2+R_p+1+\mu R_1}$$

$$\text{input impedance} = R_1 + \frac{R_p+R_2}{1+\mu}$$

$$\text{output impedance} = R_p + 1 + \mu R_1$$

Notice also that the output is in phase with the input: the  $180^\circ$  phase shift of the grounded cathode stage is not obtained with grounded grid or grounded plate (cathode follower).

**It has its uses**

At this point you may ask why the grounded-grid stage should be used at all: the only important feature seems to be that it needs a lot of power to drive it. The answer is that it is very easy to drive it into grid current, because of the low-impedance grid path, and in consequence a triode can be driven over a much bigger plate swing. My 12AT7 is found to operate linearly up to  $e_c = +3$  volts, instead of being limited to the negative grid voltage region. Just what this means can be seen by looking at the tube characteristics shown in Fig. 5: the positive grid characteristics were taken on a cathode-ray oscilloscope and are thus not very exact, but in view of the large tolerances which are normal for tube characteristics this is not particularly important.

If we consider the probable working range of the 12AT7 with positive grid drive, we see that instead of working through the point A (Fig. 5) with a load of 15,000 ohms we can work through B with a load of 5,000 ohms. For the first case we get a peak voltage of about 40, the maximum power will be  $(40)^2/2 \times 15,000 = 53$  mw., while for the second case the peak voltage is 50, and maximum power is about  $(50)^2/2 \times 5,000 = 250$  milliwatts. The actual power supplied from the plate supply increases, in this example, from  $120v \times 4 \text{ ma} = 0.48$  watt to  $120v \times 10 \text{ ma} = 1.2$  watt, but the efficiency is doubled. The audio designer who believes in triodes at all costs (and there are still quite a lot of people who distrust the pentode and tetrode) thus has a chance of getting more reasonable efficiency from his triodes.

The input impedance is made up of the cathode resistance and a term  $(R_p+R_2)/(1+\mu)$  which, when the tube

is matched, is simply equal to  $2/g$ . It is easy to see from Fig. 5 that  $g$  in the working region is about 6,000  $\mu\text{mhos}$ , so that  $2 \times 250/g = 80$  ohms. The input power needed to give our theoretical 250 milliwatts is thus, neglecting grid current,  $3^2/2 \times 80 = 56$  milliwatts. Grid current will amount to about 2 ma extra current to be provided at the peak cathode current, and this will bring the input power needed by the grounded grid stage quite appreciably above the maximum power we can get from a conventional grounded-cathode circuit.

In practice we have found the limitations of the driver result in a maximum output power of about 200 milliwatts. The power gain obtained from a complete 12AT7, with transformers designed for the same input and output impedance, and covering the usual audio band, is about 50 db.

**Positive feedback**

Since the first half of a 12AT7 will not give enough power to drive the second half fully, we are in rather a spot. The solution is to make the second half, the grounded grid stage, help to drive itself. This we can do by means of our old friend positive feedback. What happens if we apply feedback to the grid of a grounded-grid stage? You will not, I think, find the answer in the textbooks, and so you must bear with just a little more mathematics. We go to our first equation,  $e - \mu e_c = i(R_1 + R_p + R_2)$ , and now we say that to  $e_c$  we will add a fraction of the plate voltage  $kiR_2$ , so that  $e_c = iR_1 - e + kiR_2$ .

Substituting this in the original equation we have

$$e(1+\mu) = i(1+\mu R_1 + R_p + 1 + \mu k R_2)$$

From this we can see that the voltage amplification,  $iR_2/e$ , is

$$m = \frac{1+\mu R_2}{1+\mu R_1 + R_p + 1 + \mu k R_2}$$

the input impedance

$$e/i = R_1 + \frac{R_p}{1+\mu} + \frac{1+\mu k}{1+\mu} R_2;$$

$$\text{the output impedance} = \frac{1+\mu R_1 + R_p}{1+\mu k}$$

The amount of feedback is defined by the factor  $k$ . If  $k$  is positive, the feedback is negative, while a negative value of  $k$  corresponds to positive feedback. For use in our amplifier the choice of  $k = -1/\mu$  is of special interest. This value of positive feedback gives;

$$m = \frac{1+\mu R_2}{1+\mu R_1 + R_p}$$

input impedance =  $R_1 + R_p/1+\mu$ , and output impedance =  $\infty$  (infinity).

If we leave out the cathode resistor  $R_1$  we see that the voltage gain is doubled by using this amount of positive feedback and taking a load resistance  $R_2$  equal to  $R_p$ . At the same time the input impedance is reduced to  $1/g$  instead of  $2/g$ . Consequently we need only one-half the previous driving power. This brings us very nicely into

the range of the grounded-cathode driver stage. The way is thus cleared for the design of a simple audio amplifier. The circuit diagram appears in Fig. 6.

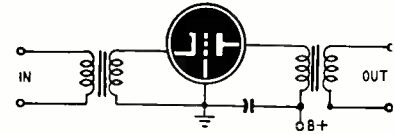

Fig. 1—The grounded-grid amplifier is much better known in the u.h.f. spectrum than at audio frequencies.

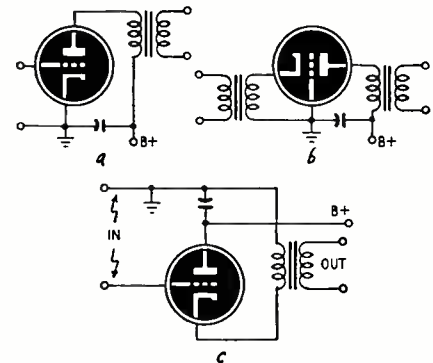

Fig. 2—The three practical ways in which an amplifier can be hooked up: with grid, plate or cathode grounded.

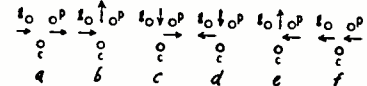

Fig. 3—All possible ways of hooking up a triode tube. Two are impractical and one used only in special circuits.

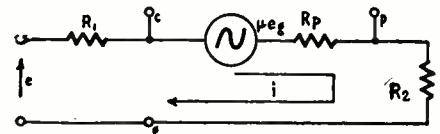

Fig. 4—Circuit of the grounded-grid amplifier drawn in equivalent form.

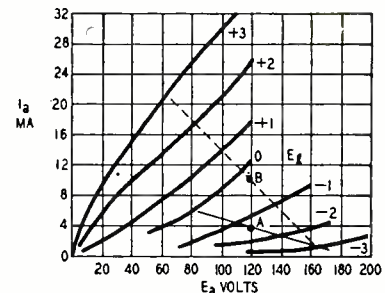

Fig. 5—The grounded-grid circuit can be run into the positive-grid region.

The output transformer, T3, has three windings: the main windings are designed to suit the load, and I shall take a 500-ohm line for design purposes. The optimum plate load is 5,000 ohms, from Fig. 5, so that the turns ratio will be  $\sqrt{5,000/500} = 3.16:1$ . The step-down from the plate winding to the grid is to be  $1/\mu$ , which is  $40-1$ . If we want the amplifier to have a response extending below 100 cycles, we can

take a line inductance of 1 henry, which gives a 3-db drop at 80 cycles. The other inductances are then 10 henries and  $10/(40)^2=6$  mh. This last winding must have low d.c. resistance, so that grid current can flow, but there will not be much trouble with such a low inductance. The interstage transformer must match the ordinary class A stage to the cathode circuit, and must therefore have a ratio of  $\sqrt{(15,000/160)}$  or about 10:1.

Including an interstage transformer makes it fairly straightforward to add negative feedback either from the output plate itself or from the line side of the output transformer. There are difficulties in practice, of course, especially if you want to take the feedback from the line winding, because then there are two transformers in the loop, and the resulting 24 db/octave slope of the total cutoff means you must stagger the cutoffs rather well. If the feedback is taken from the plate the shunt capacitor shown in Fig. 6 will help to supply you with the needed stability.

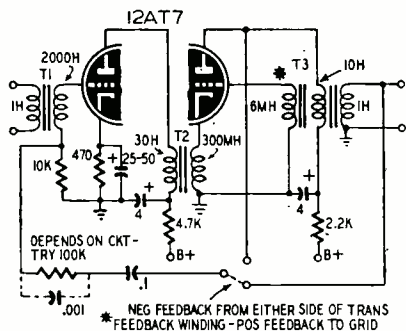

Fig. 6—Practical grounded-grid amplifier circuit, with both positive and negative feedback. Special transformers are required in the circuit.

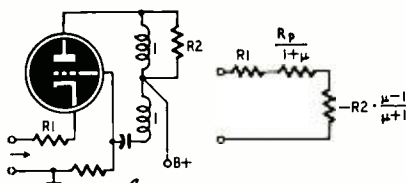

Fig. 7—Negative-resistance circuit.

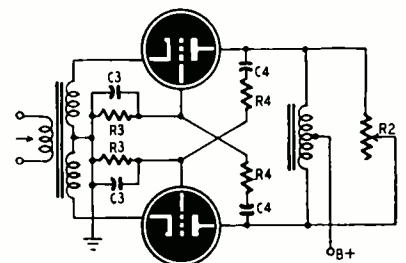

Fig. 8—This push-pull negative resistance circuit can be used as an oscillator or a high-gain amplifier.

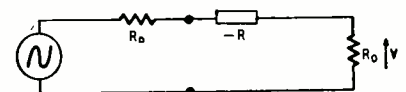

Fig. 9—Equivalent diagram of the negative-resistance circuits above.

The outline of the simple 12AT7 amplifier will, I hope, help you to design something more powerful. The sort of amplifier most readers will find interesting is probably a booster amplifier, to tack on behind an existing power amplifier. This is how the radio-frequency designers use the grounded grid: They take a 300-watt transmitter and add a 1-kw stage, and then a 3-kw stage, and so on. If you have a 3-watt audio amplifier you can use this as a driver for a 10-watt grounded-grid stage: the low impedance output of your present 3-watt amplifier will probably give enough volts to drive the grounded grid input, and it is easy to check this in the tube characteristics.

### Negative resistance

I have skipped through this aspect of grounded-grid use in order to have space to look at some other consequences of the equations. As we saw above, with positive feedback of  $k = -1/\mu$  the output impedance is infinite. The general equation for the input im-

$$pedance, R_{in} = R_1 + \frac{R_p}{1+\mu} + \frac{1+\mu k}{1+\mu} R_2$$

reduces, if  $R_1=0$  and  $R_2=R_p$  to

$$R_{in} = \frac{2+\mu k}{1+\mu} R_2$$

By taking  $k = -2/\mu$  we make the input impedance zero. At the same time the gain becomes infinite. This is therefore a rather important value of positive feedback: any more feedback will make the input impedance negative.

The other interesting value of  $k$  is  $k = -1$ . This makes the input impedance

$$R_{in} = R_1 + \frac{R_p}{1+\mu} + \frac{1-\mu}{1+\mu} R_2$$

Now  $\mu$  is usually fairly large: for the 12AT7 it is about 40-60. Consequently  $(1-\mu)/(1+\mu) \approx -1$  and the input impedance is

$$R_1 + \frac{R_p}{1+\mu} - R_2$$

As  $R_2$  is about the same order as  $R_p$ , the term  $R_p/1+\mu$  does not have much effect on the negative impedance. It is not very difficult to show that if  $\mu$

changes by 10%, the term  $\frac{1-\mu}{1+\mu}$

changes by  $\frac{2}{1600}$  of 10%. The circuit thus

provides a very stable sort of negative resistance. Before explaining how we can use this I shall show how we actually obtain it. The essence of the circuit is shown in Fig. 7-a, in which a 1-1 transformer—a center-tapped choke—provides the phase reversal to make  $k = -1$ . The R-C circuit in the grid is just to keep the plate-supply voltage away from the grid. The equivalent circuit is shown in Fig. 7-b. Nowadays we usually seem to get two small triodes in every bottle, so we can elaborate Fig. 7 into Fig. 8, a push-pull version of the same circuit. For audio work, we can have  $R_4=10,000$

ohms and  $R_3=1$  megohm.  $C_4$  is chosen to produce a cutoff in the region of 200 cycles, say 0.1  $\mu f$ , while  $C_3$  provides a top cutoff, which may be at 5,000 cycles, and then  $C_3$  will be 75  $\mu f$ . At frequencies in the middle of the band, when  $C_4$  can be taken as a short circuit and  $C_3$  as an open circuit,  $k = -0.99$ . The input impedance is then  $\frac{2R_p}{1+\mu} - \frac{R_2}{n^2}$ .

Without going into too many details, it is sufficient to say that the value of  $n$  is chosen in the same way as if the transformer was to work into a resistance of  $R_2$ , and  $R_2$  should be about 10,000—15,000 ohms for a 12AT7 tube.

What is the object of producing this negative resistance? There are three sorts of job for which negative resistance is useful. It can be used with a tank circuit to provide an oscillator, it can be used in a filter to improve the Q of a coil; or it can be used in a special sort of amplifier circuit. This last is the application for which the circuit of Fig. 8 is of special value. Consider the very simple circuit of Fig. 9. A generator of impedance  $R_0$  is connected to a load  $R_0$  through a negative resistance  $-R$ . Current is  $i = e/(2R_0 - R)$  and the voltage across the load will be  $eR_0/(2R_0 - R)$ . The voltage without  $-R$  in circuit would be  $e/2$ , so that the negative resistance produces a gain of  $2R_0/2R_0 - R$ . This can be rearranged as  $1/(1 - R/2R_0)$ . Suppose we adjust  $R_2$  in Fig. 8 to make  $R = \frac{3}{2} R_0$ . The gain will then be 4 times, or 12 db.

Fig. 9 is completely symmetrical, and if the voltage  $e$  acted in series with the  $R_0$  on the right there would be a gain of 12 db in transmitting from right to left. A negative resistance amplifier can thus be inserted in a line to give a gain in both directions.

An amplifier of this kind is an ideal form of amplifier to add to an intercommunication system when a gain of about 6-12 db will make all the difference between comfort and strain to the user. The actual circuit is described by Merrill, in the *Bell System Technical Journal* (Jan. 1951, XXX, p. 88), and the amplifier is known to Bell as the El repeater. Mr. Merrill's description, however, is strictly long-haired.

### For the future

Two topics have been left in the air in this article. One is the design of a genuine power-stage grounded-grid amplifier. I do not see much hope in the near future of getting down to the construction of a stage of this kind. The reader who is armed with the analysis above and the characteristics of his favorite tube can try one of them for himself.

The other topic is the general one of negative resistance, which is more complicated than you may think. I shall try to clear my own mind on this subject, and then see if I can explain it to you. END





# UNIVERSAL SPEAKER for the SERVICE BENCH

By ALAN G. SORENSEN

**S**ERVICE TECHNICIANS often require a test speaker unit. One which can be built easily is a welcome addition to the shop. Almost all television sets and radio-phono combinations have their speakers mounted in the cabinet or at other locations and not on the chassis. In servicing this type of equipment a bench speaker saves labor and time.

This unit also provides a line transformer. This feature is very useful in audio work where 500-ohm lines are often encountered. The output transformer is a universal type and can be substituted for almost any transformer the service technician will find. Primary impedances from 1,500 to 20,000 ohms can be matched by only two switches.

Fig. 1 is the circuit diagram of the unit. The wiring is simple and straightforward. The output transformer is a Stancor A-3852, which is a very flexible unit. The chart supplied with the transformer was glued to the underside of the hinged cabinet lid. Secondary taps for impedance matching are selected by switches S3 and S4, whose positions are marked 1 through 6 to correspond with the chart. The function switch (S1) may be set to OFF position and an external speaker connected to terminals VC or set to the OUTPUT position to operate the internal speaker.

Small color dots of blue, red, and brown were painted above the letters P, B, and P at the output transformer primary pin jacks. For single-tube output the brown P and red B are used; plate and B plus, respectively. For push-pull operation all three are used.

The line transformer is a Stancor type A-3883 and matches a 500-ohm line to voice-coil impedances of 4, 6, 8, and 15 ohms. This transformer is useful in working with audio equipment

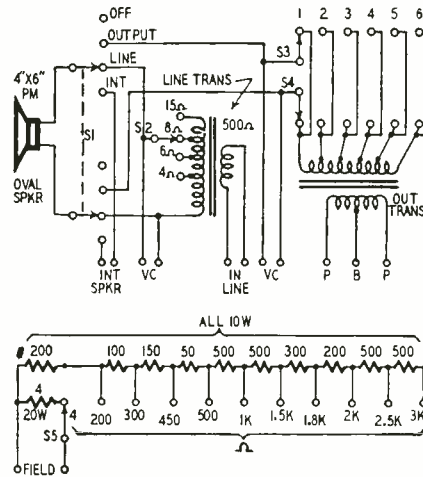

Fig. 1—Circuit of the universal unit.

and communications receivers. Switch S2 was placed on the lower right-hand side of the panel, while the line transformer pin jacks were positioned on the upper left-hand side. This balances the panel layout and improves the unit's appearance. Again, the function switch may be positioned either at LINE or at OFF, depending upon whether the internal speaker is to be used or disconnected. The VC terminals may be used for an external speaker.

When the function switch (S1) is set at INT the internal speaker is connected to the INT SPKR terminals and may be used separately.

The FIELD switch (S5) may be used to replace virtually any field coil at power levels up to at least 10 watts. All resistors in the string are rated at 10 watts with the exception of the 4-ohm unit which is rated at 20 watts. A chart was made and glued to the top of the chassis. Since the switch has 30-degree spacing it was decided to use a National HRS-3 knob to simplify panel marking.

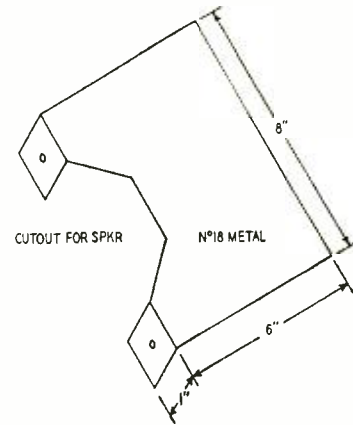

Fig. 2—Details of chassis plate.

The cabinet is an ICA 3926, 8 x 12 x 8 inches. The finish is gray wrinkle. The 8-inch chrome strip which was added for decoration was obtained from Allied Radio; number 86-366. A white flocked screen and a brass grill were placed over the speaker opening. The chassis is an 8 x 7-inch piece of No. 18 sheet metal cut and bent as shown in Fig. 2. Exact size and shape will depend on the speaker used. The wiring is point-to-point. Parts placement is not critical and the layout may be changed to suit the individual constructor.

The technician will find a test speaker unit a worthwhile addition to any service bench. The saving in labor time can easily pay for it in a short time. END

### Materials for test speaker

**Resistors:** 1—50, 1—100, 1—150, 2—200, 1—300, 4—500 ohms, 10 watts; 1—4 ohms, 20 watts.

**Switches, rotary:** 1—4-contact, 2—6-contact, 1—11-contact; 1—2-gang, 4-contact.

**Transformers:** 1 output transformer, Stancor A-3852 or equivalent; 1 line transformer, Stancor A-3883 or equivalent.

**Miscellaneous:** 1 speaker, good quality, PM type, big enough for type of work to be handled. Cabinet and chassis, as per text. Jacks, hardware, wire, etc

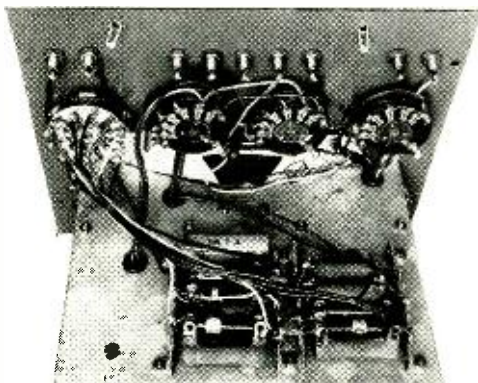

Fig. 3—Field resistors and switches.

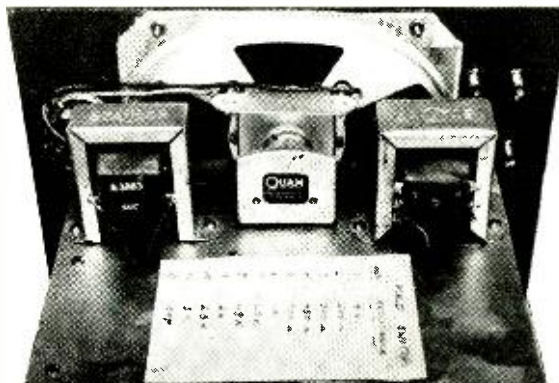

Fig. 4—Balanced layout of large components.

# HI-FI COMES TO THE MUSIC LOVER



De luxe trailer studio carries quality home-type audio equipment on nationwide demonstration tour

By HOWARD SOUTHER\*

**T**HE story of the Electro-Voice Audio Caravan starts with a discussion of the conditions which brought it into existence.

Present day radio-phonograph combinations do not satisfy the quality requirements of most serious music listening. Passing only 5 octaves out of a possible 10, the usual home listening setup arouses little emotional stimulus, and serves as only a fair means of communicating the barest intelligence.

During recent years, the country has experienced unusual developments in the art of high-fidelity reproduction. There exists now a fast-growing coterie of high-fidelity enthusiasts. They assemble this changer, that amplifier and tuner, and a choice of five or six makes of fine high-quality loudspeaker systems, to achieve a musical result in their own home that is startling in its satisfying realism.

Good reproduction of fine musical programs has just recently come into being, emerging from a dubious art into a rather well-founded science. The enthusiast or hobbyist has nursed this new business through its growing pains; now the manufacturers of high-quality sound equipment have discovered that they have products with a thoroughly universal appeal. The target of this appeal consists of the millions of *music lovers* throughout the United States and—somewhat secondarily—the world.

This target is reached only by exposing the product—in other words by ad-

vertising, which takes many forms. The advertising form most suited to high-fidelity is *actual demonstration*. Demonstration, along with *making the product available for sale*, constitutes *merchandising*, insofar as it concerns high-fidelity equipment.

Here lies the rub. The radio-music dealer has found it difficult, and has been reluctant to merchandise high-fidelity sound. In the past he was either not technically qualified to handle its complexities, or he was kept too busy merchandising television to bother. The upshot was that the wholesale radio parts distributor was forced to engage in selling direct to the ultimate consumer. So far this consumer has been only the hi-fi enthusiast, and the music lover has been left waiting to be exposed to the new thrills of home-reproduced quality sound.

The hi-fi enthusiast is used to seeking out the parts distributor, because the essence of his hobby is not just music listening, but includes assembly and experiment, and in his enthusiasm, he will go to great lengths to ride his hobby. The music lover, on the other hand, is a subjective individual concerned solely with the final delivery of fine music to his ears. He hardly knows what a parts distributor is. He is conditioned to making his purchases from community retailers and the downtown department and music stores—so the experience of home high-fidelity listening completely misses him.

The reasons for the Electro-Voice Audio Caravan are to engender interest

high-fidelity on the part of the dealer and distributor *and to take equality sound directly to the ears of the music lover*.

This could be augmented by the presence of the Audio Caravan at technical seminars, conventions, electronic shows, universities, and all the varied types of meetings conducted by civic and national groups.

The tide in the affairs of high-fidelity appears to be at the flood, so one day the boss said, "Go ahead—let's start the trailer project!"

We called the Freuhauf Trailer people and found out that their largest trailer was 38 feet long and contained 1,800 cubic feet. The proportions were pretty good, with head-room to spare, so we ordered one.

The metal shell of the trailer was just that—a shell. We had plenty to do. Generous quantities of *Kimsul* insulation against noise and weather were installed between 16-inch joists. Over this we applied heavy wood paneling to form a foundation for the fixtures, platforms, and showcases which were to come later. The ceiling was formed of a fine acoustic tile called *Transite*. The wall covering was a simulated cloth made of plastic, which turned out to be colorful, durable, and, most important, washable.

While this work was going on, our cabinet maker constructed the massive "picture-frame" showcases, and the sound channel was designed to provide the link between the Electro-Voice microphones and cartridges to the vari-

\* Manager, Speaker Division, Electro-Voice Inc., Buchanan, Michigan.



## H. F. RESPONSE IMPROVED BY EGGSHELL IN SPEAKER

Rudi Pfenninger, noted German authority on synthetic music and high-frequency speakers, recently demonstrated an ingenious trick for improving the h.f. response of a cone type speaker. The pointed half of an eggshell, cemented in the center of the speaker cone, gives a remarkable improvement in h.f. response.



Cutting the shell requires care and patience. Place a hard-boiled egg, pointed end up, in an egg cup, and very carefully scribe a line around the outside (slightly below the greatest diameter) with a fine-bladed knife. Then slowly and delicately file through the shell along the line with the edge of a triangular needle file, *holding the egg only at the tip*. When the shell has been filed through all around, slice through the egg with a razor blade. Remove the yolk and white from the top half (don't crack the shell while doing this!) and let the shell dry completely. Then smooth the filed edge with fine sandpaper. Fasten the shell to the apex of the speaker cone with Duco or speaker cement.

The shell was tested on a handmade 10-inch speaker which had excellent bass response but was very poor on the highs. The improvement was remarkable. As was expected, the newly heard high frequencies were strongest along the axis of the cone.—*Funkschau, Munich, July 1, 1952*

(Some commercial speakers have been manufactured with egg-shaped dust caps over the voice-coil opening, but without any claims that this was done to improve high-frequency radiation. In this case, the extremely light weight and rigidity of the eggshell permit it to vibrate more effectively at high frequencies than the relatively heavy cone. The walls of the cone act as a reflector to direct the high-frequency vibrations toward the listener. The curvature of the main cone would determine the angle over which the highs are radiated.—*Editor*)

END

Part of the trailer interior. Mixer console and tape reproducer are at the left. Special acoustic treatment was needed to overcome space limitations.



ous Electro-Voice-Klipsch loudspeaker systems which were to be demonstrated.

Considerable care was given to this phase of the project. We talked to Art Davis of the Cinema Engineering Company in Burbank, California, and decided that we should use a standard professional mixer setup, such as those used in recording and motion-picture studios. This would permit easy switching of all the types of input sources we wanted to use. These were phonograph, radio, microphones, and tape. In addition, we required high quality and serviceability to insure an effective and lasting demonstration setup.

Using the ready-built amplifier components supplied by Cinema Engineering made the construction of the mixer and sound channel quite simple, resolving the matter into one of straightforward mounting and interconnecting. The first time the power was applied, everything worked to perfection!

Adequate switching facilities provided instantaneous A-B comparisons between speakers. In addition, records, tape, microphones, and radio can be faded in and out at will for playback, tape recording, and tape dubbing.

Several days before the Chicago Radio Parts Show last May, we put the finishing touches on the Audio Caravan and hitched on our prime mover, a Chevrolet cab-over-engine affair. Blithely we took the rig for a short spin and nonchalantly stopped at a filling station for a fill-up of gas. We understood the eagerness with which the filling station attendant took our order when he presented us with a bill for 175 gallons!

There were more surprises in store for us. On our first field trip, or shake-down cruise, we found that the trailer performed beautifully on the road. The ride was smooth and easy; steering and handling were much more simple than anticipated. Perhaps a contributing factor was the enthusiasm with which the competing traffic got out of the way at the sight of this rolling behemoth.

Brimming over with confidence, we pulled up on the main street and attempted to park next to the curb in a spot which had been reserved for us. After twenty-five minutes of fruitless backing and filling, a kind truck driver who was stalled behind us came over and expertly placed the Audio Caravan next to the curb. He agreed with us that we needed quite a number of additional driving lessons.

This was our first showing to the consuming public on a main thoroughfare. The crowd which had been watching our parking operation with tongue-in-cheek, immediately filed into the trailer and we proceeded to put on our demonstration with some rather unusual results.

One end of the trailer interior is raised to simulate a stage. When we mounted the rostrum to begin our show, we, as well as the audience, were thoroughly discomfited to find only one loudspeaker which could be used. This was the large Empire system on the platform—the rest of our speakers were spotted on the floor and low platforms, with the result that the audience totally obscured and muffled them. (All speakers were raised at the first opportunity.)

Part of the exploitation program is to give away 7-inch Columbia transcriptions which contain excerpts of the disc and tape selections used during the demonstration. The demonstration lasts about seventeen minutes, but after three hours, we noticed here and there some of the same faces we had seen earlier in the day. These people were sitting through the same program, time after time, in order to receive a duplicate and triplicate free disc. We solved this problem by announcing that everyone could have as many copies of the give-away disc as they had use for.

It would appear that the Audio Caravan has high appeal, not only for those who view it, but for us who operate it. Especially since we plan definitely to include Florida in the itinerary of the demonstration unit in December! END

# TAPE RECORDING

By I. QUEEN

Editorial Associate

## PART 3—Home and Office Models

THE machines described here sell for between \$100 and \$275. In most cases, tape speed is 3.75 or 7.5 inches per second or both. Fidelity is good to about 7 kc. These home and office models are portable and simple to operate. They perform well for long periods with little maintenance.

In these models, equalization varies from manufacturer to manufacturer. In each case the over-all compensation is correct, but some boost treble mostly during recording, while others may do it during playback. Because of this lack of standardization, tape recorded on one machine cannot always be played back on another without distortion.

Representative tape recording models are described below. Most of the manufacturers mentioned make more than one type. Many of them also sell tape accessories like continuous loop magazines, bulk erasure units, foot controls, and pickups for telephone conversations, especially for the higher-priced machines.

### Pentron

Model 9T-3C has two speeds: 3.75 and 7.5 i.p.s. (inches per second). It has two input jacks—for mike and radio. Another jack is provided for an external amplifier or PA system and a fourth for an external speaker only. A 6V6-GT tube is the *power amplifier* during playback and the *h.f. oscillator* for recording. This model features an "editing key." The recordist can delete or add to a recording while the tape is playing. Tape is rewound at the unusually fast speed of 13 feet per second.

Fig. 1 shows the playback equalizer.

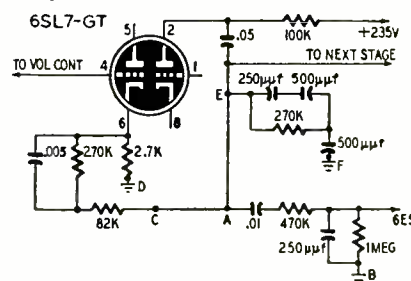

Fig. 1—Pentron playback equalizer. Inverse feedback network from pin 2 to pin 6 (C-D) raises bass response. The shunt network (E-F) reduces h.f. gain.

The network between points C and D is a high-pass circuit. It feeds back voltage from the plate of the second triode to the cathode of the first. It boosts bass. The electron-ray indicator is fed from a filter (between A and B). The main load of the second triode is the network between E and F. This also boosts bass.

### Tapemaster

Model PT-125 is composed of two units: a transport and a preamplifier. It can be used with an external amplifier or radio. Speeds are 3.75 and 7.5 i.p.s. The preamplifier meets high standards. Wow is claimed to be less than 0.5% and maximum distortion less than 3%. The h.f. oscillator uses a push-pull circuit.

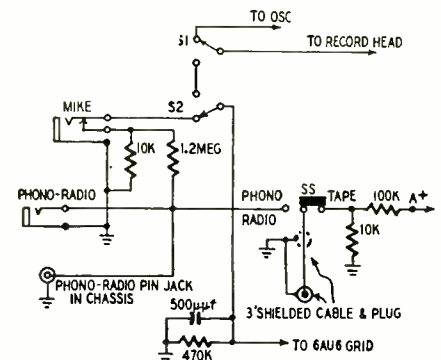

Fig. 2—The Tapemaster input selector.

The input circuit is shown in Fig. 2. A voltage divider reduces the relatively strong signal from a phono or radio. With SS on its left contact, phono-radio signals are shunted through a shielded cable as shown. This cable plug is inserted into the external radio or amplifier. Thus the preamp is taken out of the circuit without removing any connections. For tape listening, SS is switched to TAPE. The output of the preamp (point A) now feeds through the shielded cable and into the external amplifier.

### Webster-Chicago (Webcor)

Model 210 provides 3.75 and 7.5 i.p.s. tape speeds. It is equipped with two motors, heads and associated parts. Each head contacts one of the tape tracks. One head is effective during *for-*



A—Revere TR-200 with AM radio. B—Permoflux "Scribe". C—Universal Electronics "Reelest". D—Tapemaster PT-125.



ward tape travel. The other is in the circuit during *reverse*. Heads are controlled automatically when direction is changed. This eliminates the need for rewinding the tape. When the roll comes to an end, the machine is reversed. This automatically ends the first track and starts the second. Reels don't have to be taken off their spindles and interchanged. One motor drives the capstan only, to assure minimum wow. The other drives the takeup reel.

This model has multiple output connections. They are: listen, external speaker; output (1-10 volts) for external PA or amplifier; low speaker level for monitoring. The recording indicator is an electron ray indicator tube. See Part I of this series for details of the equalization networks. Extensive service data and operating instructions are available from this manufacturer.

**Webster Electric (Ekotape)**

Model 114 has a speed of 3.75 i.p.s. Model 116 is built for 7.5 i.p.s. Otherwise these machines are similar. Each has an extra-large flywheel for minimum wow. Forward and reverse rewind is done at 20 times normal speed. These models may be adapted for a foot switch to aid in tape editing. A continuous-tape magazine is also available.

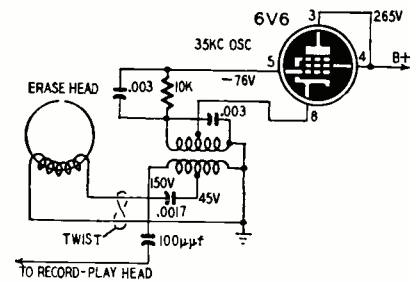

Fig. 3—Ekotape bias-erase oscillator.

Fig. 3 shows the h.f. oscillator. It operates at a frequency of 35 kc. About 150 volts of a.c. is fed to the record-play head. The erase head requires only about 45 volts. The 6V6 tube is inoperative during "playback."

**Ampro**

Model 731 is very compact. It weighs 17 pounds, and measures only 11 x 8 x 12 inches. It uses only three tubes plus a power rectifier. Tape speed is 3.75 i.p.s. There is a single (high-impedance) input channel. PM erasure is provided. This machine needs no lubrication. A continuous magazine (for 2½ minutes) may be added if desired.

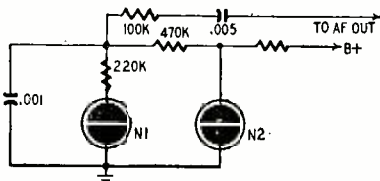

Fig. 4—Ampro level indicator. N1 flashes when peaks exceed d.c. bias from N2.

This model has a simple yet effective level indicator. See Fig. 4. N-1, the

indicator, is supplied with both regulated d.c. and with a.f. from the power tube. The d.c. remains constant so N-1 actually indicates the a.f. peaks. N-2 is the regulator lamp, which compensates for line variations or changes in the circuit.

An adapter cable is available for radio recording. Two clips are attached across the speaker voice coil.

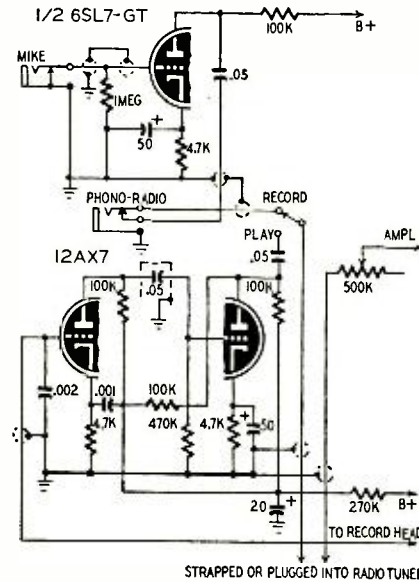

Fig. 5—Masco recorder input preamplifier and record-playback selector circuit.

**Masco Electronic Sales**

Series 52 recorders have two speeds: 3.75 and 7.5 i.p.s. Models R, LR, and CR also have AM tuners for recording direct from radio. All series 52 recorders have two heavy-duty motors with oilless bearings. A full 5 watts can be fed to an external 500-ohm speaker. Flutter is kept below 0.3%. The indicator neon lamp is used as a pilot during "playback." A separate "press-to-record" button prevents accidental erasure.

Input and preamplifier circuits are shown in Fig. 5. The 6SL7-GT triode is used for mike preamplification only. A 12AX7 is the tape preamplifier. Feedback between the second plate and the first cathode boosts bass. Note the shielded leads for radio pickup which feed directly into the main amplifier.

**Universal Electronics**

Reelst model C-1-A runs at 7.5 i.p.s. Unlike most other portables, it can play a 7-inch reel with covers *closed*. It also features automatic tape reversal. This is done by a contact sticker applied to the tape at the desired point. The metal sticker touches off a switch and energizes a solenoid. The level indicator is an electron-ray tube.

Model PT-3M has an unusual record-playback head. It is automatically moved upward during a forward run. Here it contacts the upper track. When the machine is reversed, the head is moved down where it contacts the lower track. Rewinding is eliminated and tracks may be changed without "flopping" or interchanging reels. This head has twice

the life of ordinary types. When it becomes worn, simply loosen it and rotate through 180 degrees, and you have a second surface for further use. This model has two erase heads, one for each track (since the tape is always erased before recording). The erase heads are on either side of the recording head. They are switched automatically every time the tape direction is changed.

Fig. 6 shows input connections to the Reelst. Ganged switch SW1, SW2 has 4 positions: mike, phono, radio, and tape. Any one of the first three is recorded by turning on the recorder and switching SW as desired. The fourth position feeds tape signals for playback. SW2 connects any desired channel to an external amplifier. Phono or radio is fed



E—Bell RT-65 "Recordfone". F—Voice-Master magnetic-disc recorder. G—Pen-tron model 9T-3C. H—Masco model 52.





# short circuits

Bandspread circuits  
and their applications **By ROBERT F. SCOTT**  
in modern receivers

Technical Editor

FOR several years I have wondered at the reluctance of the average service technician to attempt to realign the shortwave bands of an all-wave receiver. The man who tries to do the job may be a whizz on realigning broadcast sets but he is still quite apt to fail miserably on a shortwave job. If you don't believe it, just ask a ham or serious SWL.

Many all-wave sets cover the shortwave spectrum from 1600 kc to 18 or 25 megacycles in two or three overlapping bands which have frequency ratios of approximately 3 to 1. Shortwave tuning circuits for the antenna, r.f., and oscillator are usually identical to and just as easy to realign as the broadcast. Of course, the manufacturers' instructions should be followed to the letter. Since the dial scales of many of these sets are not closely calibrated and equipped for fine tuning, standard signal generators are good enough for the job and no special care is needed.

The jobs that really make the boys head for the hills are those which have elaborate electrical bandspread systems to spread each international shortwave broadcast band over one sweep of the tuning dial. As Table I indicates, the width of the bands vary from 400 kc to 1.6 mc. When these are spread across the dial, the frequency tuning ratio averages about 1.07 to 1. Since the tuning arrangements for these bands vary considerably from those for the broadcast band, we feel that service technicians will be interested in an explanation of the most commonly used bandspread circuit arrangements.

A considerable number of shortwave listeners is always with us, besides nearly 100,000 hams, a majority of whom do not own servicing equipment. The interest in shortwave seems to be increasing, possibly due to the large number of Americans who have been in foreign countries (some of whom brought shortwave receivers back with them) and the technician who is willing to realign them will have plenty of business.

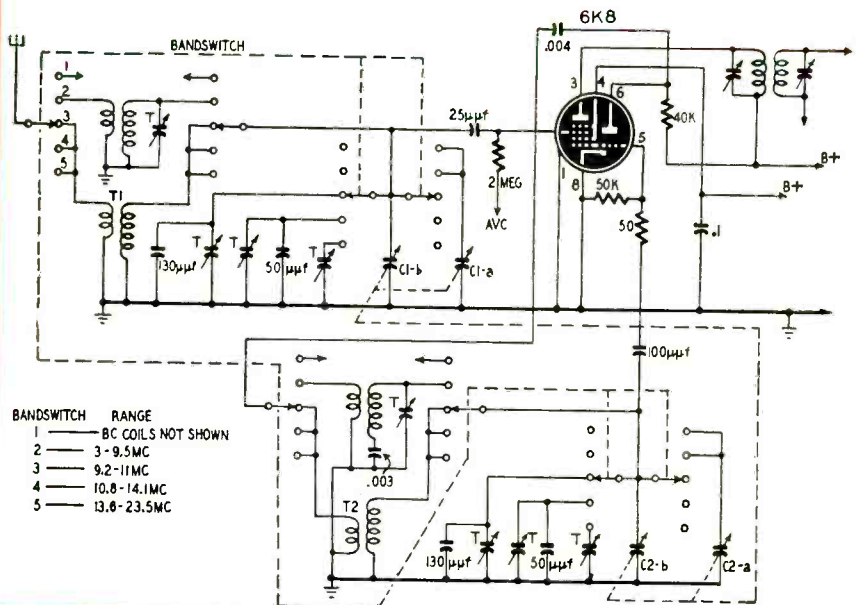
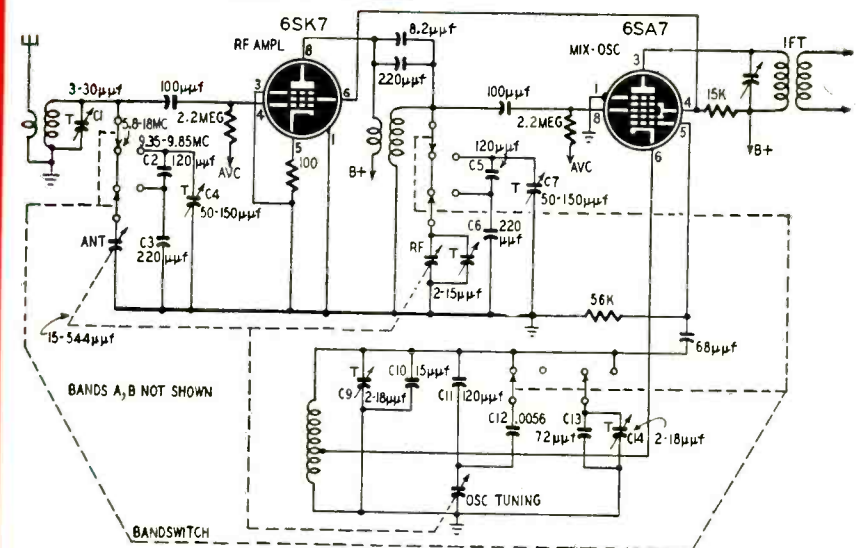
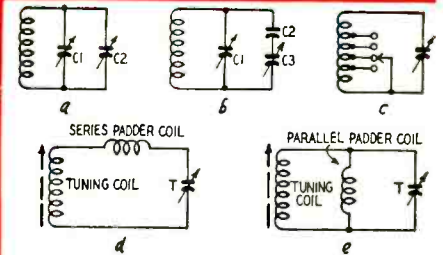
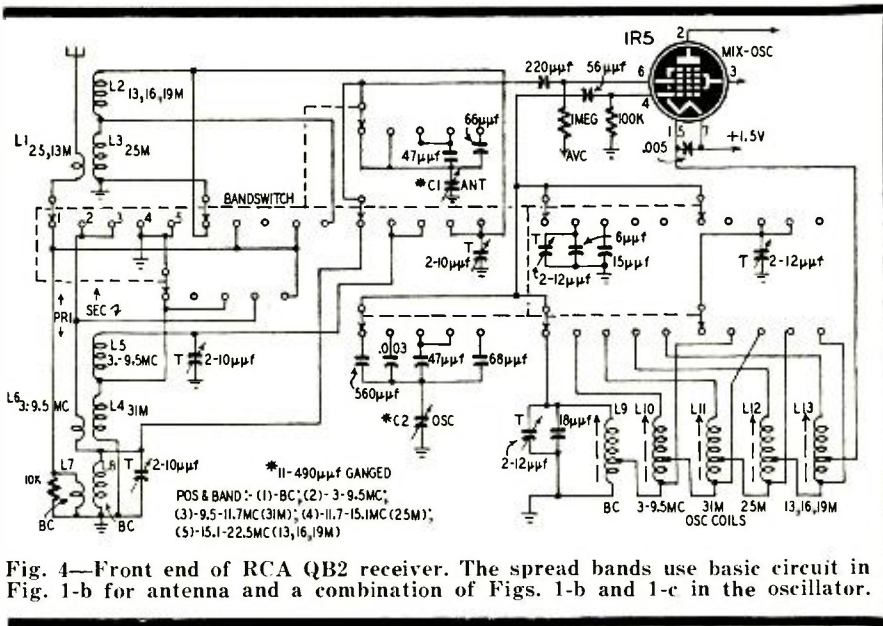

Fig. 1 (top)—Basic bandspread systems used in shortwave sets. Drawings at *a* and *b* show how bands are spread by reducing the variation in total capacitance over the tuning range. Circuits *c*, *d*, and *e* spread bands by varying the total tuning inductance. Fig. 2 (center)—Bandspread tuning circuit of RCA 111K—a version of Fig. 1-b. Fig. 3 (bottom)—Adaptation of Fig. 1-a in Sentinel 256.



How bands are spread

Tuning capacitors with maximum values ranging from 300 to 500 µf are commonly used for tuning the broadcast (550-1650 kc) band. Regardless of the maximum and minimum capacitances of the tuning capacitor, the practical capacitance ratio is usually limited to about 9 to 1 by circuit capacitances, which include the coil's distributed capacitance and stray wiring capacitances in parallel with the coil and tuning capacitor. This limits the frequency ratio to about 3 to 1—the square root of the capacitance ratio. When these tuning capacitors are used to tune shortwave bands, the frequency range becomes so great that tuning and logging of stations becomes extremely difficult. A span of several hundred kc may be covered by the width of the pointer.

Electrical bandspread systems have been developed to simplify tuning by spreading each international shortwave band over the entire span of the tuning dial. Basic bandspread circuits are shown in Fig. 1.

The circuit in Fig. 1-a is commonly used in amateur and communications receivers. C1 is the standard-size tuning capacitor. Its setting determines the minimum circuit capacitance. It is commonly called the *bandset* capacitor or control. C2 is the *bandspread* capacitor. Its maximum value is usually about 1/10 the maximum value of C1. With C2 wide open, C1 is used to tune the set to the high-frequency end of the desired band. By tuning with C2, a band of several hundred kc can be spread over the full scale of the dial of the bandspread control.

In Fig. 1-b, C1 is the usual trimmer capacitor, C2 is the padder, and C3 is the main tuning capacitor in a circuit identical to that used to tune the oscillator circuit in many superhet receivers. Since C2 and C3 are in series, the total capacitance is smaller than either. The minimum capacitance changes very little for any value of C2, but the maximum value changes over a wide range. C2 sets the lowest frequency of the circuit and is used as the bandset capacitor. The main tuning capacitor C3 becomes the bandspread capacitor.

The circuit in Fig. 1-c is familiar to builders of small regenerative receivers. By using a tapped coil and a comparatively small tuning capacitor, a wide section of the radio spectrum can be divided into a number of smaller overlapping bands by selecting the positions of the taps on the coil.

The circuit at d may be used with variable-capacitance or permeability-tuned circuits. When the padder inductor is in series with the tunable inductor, it lowers the resonant frequency and decreases the width of the band that can be covered with the tuning slug.

A parallel padder coil is shown in the circuit in Fig. 1-e. The padder coil reduces the effective inductance of the circuit and decreases the width of the

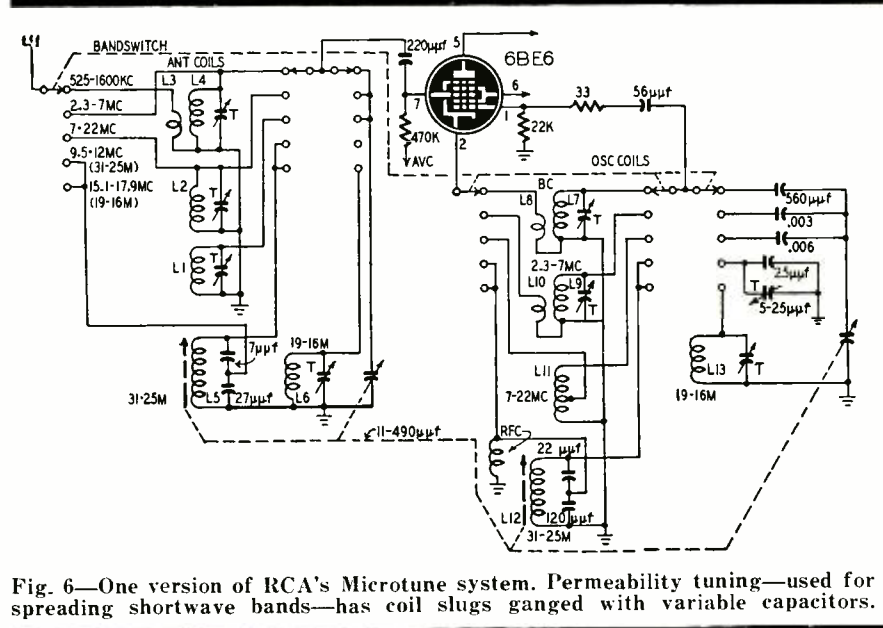
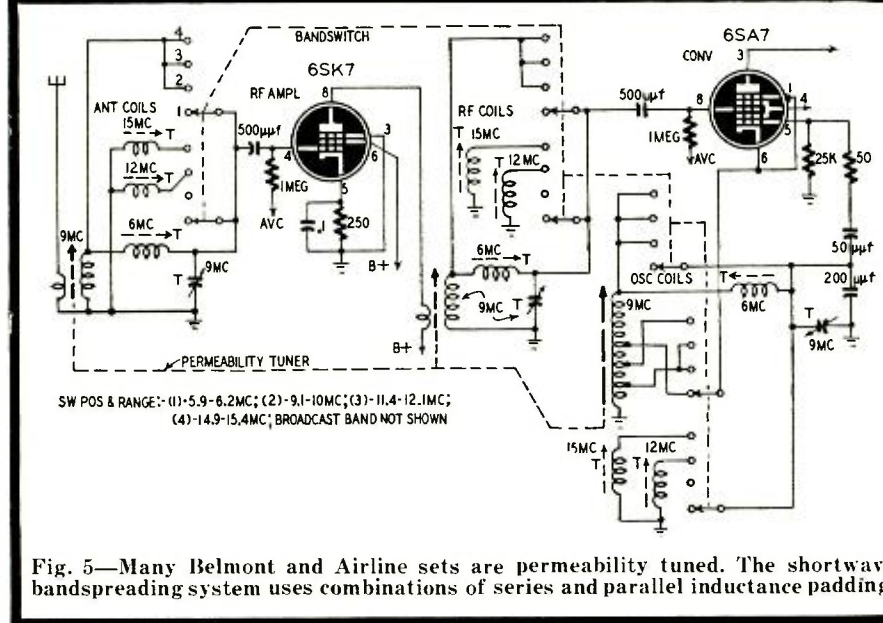



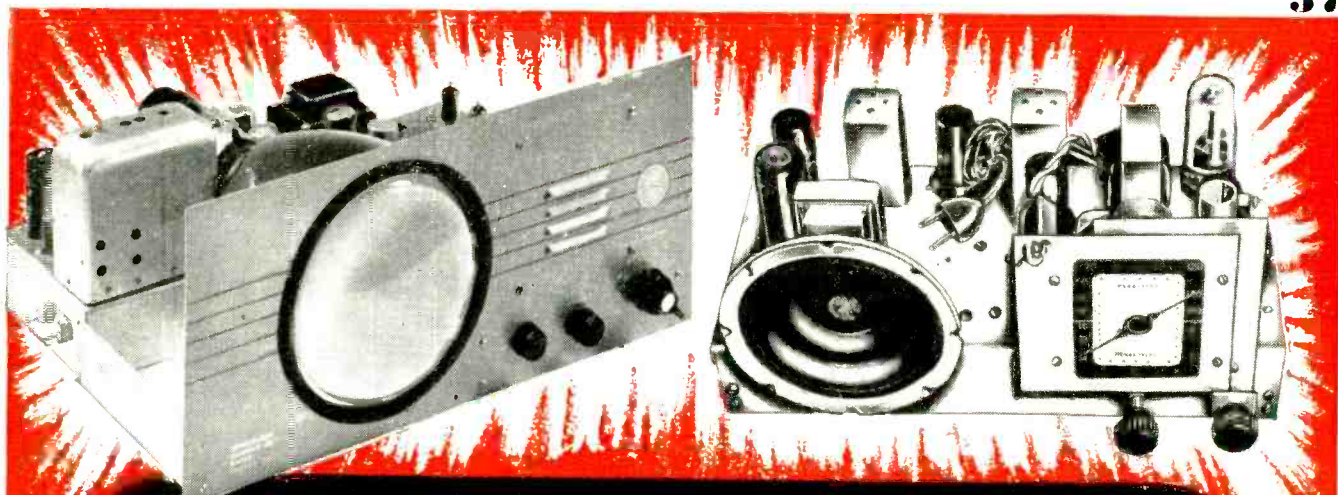

**TRAIN FASTER—TRAIN BETTER—TRAIN EASIER  
 IN 10 MONTHS—OR LESS—FOR  
**RADIO-TELEVISION****

Our 21st Year Training Men for Greater Incomes and Security in Radio-Television

**I SEND YOU  
 18 BIG KITS**

of Radio Television parts and equipment. Much of your training will be actual construction and experimentation . . . the kind of truly PRACTICAL instruction that prepares you for your Radio-Television career.

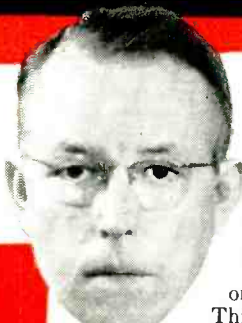

Frank L. Sprayberry  
 President  
 Sprayberry Academy  
 of Radio

**NEW! NO OBLIGATION PLAN**

**You Have No Monthly Payment Contract to Sign  
 Pay For Your Training as You Earn and Learn**

You can get into Radio-Television, today's fastest growing big money opportunity field, in *months* instead of years! My completely new "package unit" training plan prepares you in as little as 10 months or even less! *No monthly payment contract to sign—thus NO RISK to you!*

This is America's finest, most complete, practical training—gets you ready to handle any practical job in the booming Radio-Television industry. Start your own profitable Radio-Television shop . . . or accept a good paying job. I have trained hundreds of successful Radio-Television technicians during the past 21 years—and stand ready to train you, even if you have no previous experience! Mail coupon and get all the facts—FREE!

**Valuable Equipment Included  
 With Training**

The new Sprayberry "package" plan includes many big kits of genuine, professional Radio-Television equipment. You perform over 300 demonstrations, experiments and construction projects. You build a powerful 6-tube 2-band radio set, multi-range test meter, signal generator, signal tracer, many other projects. All equipment and lessons are *yours to keep* . . . you have practically everything you need to set up your own profitable Radio-Television service shop.

**Earn Extra Money While You Learn!**

All your 10 months of training is IN YOUR HOME in spare hours. Keep on with your present job and income while learning. With each training "package" unit, you receive extra plans and "Business Builder" ideas for spare time Radio-Television jobs. New television stations everywhere, open vast new opportunities for trained Radio-Television Technicians—and those in training. If you expect to be in the armed forces later, there is no better preparation than practical Sprayberry Radio-Television training.



**YOU BUILD** the Television set and the powerful superhet radio receiver shown above. IN ADDITION to the other test units shown here (many are not shown because of lack of space). All equipment I send you is **YOURS TO KEEP.**

**SPRAYBERRY ACADEMY OF RADIO 111 NORTH CANAL ST.  
 Dept. 200, Chicago 6, Ill.**

**MAIL COUPON  
 TODAY!  
 NO OBLIGATION**

**SPRAYBERRY ACADEMY OF RADIO, Dept. 200,  
 111 North Canal St., Chicago 6, Ill.**

Please rush to me all information on your 10-MONTH Radio-Television Training Plan. I understand this does not obligate me and that no salesman will call upon me. Be sure to include 3 books FREE.

Name..... Age.....

Address.....

City..... Zone..... State.....

I invite you to get all the facts—  
**FREE TO YOU 3 BIG  
 RADIO-TELEVISION BOOKS**

I want you to have ALL the facts about my new 10-MONTH Radio-Television Training Plan—without cost! Rush coupon for my three big Radio-Television books: "How to Make Money in Radio-Television," PLUS my new illustrated "Television Bulletin P." US an actual sample Sprayberry Lesson—ALL FREE. No obligation and no salesman will call. Mail coupon NOW!



band covered by the adjustable core. Capacitors in *d* and *e* set the lowest frequency which can be tuned with the combination.

### Tuning-capacitor padding

The circuit in Fig. 2 is the simplified schematic of the r.f., antenna, and oscillator stages of the RCA 111K receiver. When the band switch is in the 5.8–18-mc position, the antenna and r.f. circuits are tuned by the full capacitance range of the 15–544- $\mu\text{f}$  tuning capacitor. Although the capacitor has a ratio of approximately 36 to 1, the actual capacitance ratio is nearer 9.6 to 1 because it is shunted by stray capacitance and antenna trimmer C1. The frequency ratio is roughly 3 to 1. The mixer circuit tunes in the same way, but no trimmer is needed.

In the oscillator circuit, the trimmer consists of C9 and C10 in parallel. Padding capacitance consists of C11 and C12, totaling .00572  $\mu\text{f}$ . When the band switch is set for reception on the 31-meter (9.35–9.85 mc) band, the frequency range is 1.0 to 1.05, so padding capacitors are switched into the antenna, r.f., and oscillator circuits to limit the capacitance ratio. In the antenna circuit, C2 is the padder, C3 is the fixed trimmer, and C4 is a variable trimmer used for bandsetting. C5, C6, and C7 in the r.f. circuit correspond to C2, C3, and C4 in the antenna circuit. C4 and C7 are adjusted to peak the signal in the center of the band (9.5 mc).

In the oscillator circuit, the padding capacitance is reduced to 120  $\mu\text{f}$  by switching out C12 and leaving only the capacitance of C11. This is a modification of Fig. 1-b.

### Parallel-capacitor bandspreading

The Sentinel 256 and 257 receivers use the method of bandspreading shown in Fig. 1-a. The simplified tuning circuits of these receivers are shown in Fig. 3. C1-a and C2-a are the usual tuning capacitors. C1-b and C2-b are small bandspread capacitors ganged with C1-a and C2-a. When the set is tuned to the broadcast or 3.0–9.5-mc bands, both sections of C1 are paralleled across the antenna coil and sections of C2 are paralleled to tune the oscillator circuit.

With both sections of C1 and C2 par-

alleled across T1 and T2, the frequencies between 9.2 and 23.5 megacycles would be crowded into one sweep of the tuning dial, making it difficult to separate and log stations. So, instead of using continuous tuning, the range is split into three overlapping bands. Capacitor sections C1-a and C2-a are switched out and semi-fixed bandsetting capacitors are substituted. C1-b and C2-b are then used as the bandspread capacitors.

### Inductance-capacitance padding

A practical adaptation of the basic circuits in Figs. 1-b and 1-c is used in the tuning circuits of the RCA QB2 battery set shown in Fig. 4. On the broadcast band, the primary of the antenna transformer consists of L1 and L7 in series. L8 is the broadcast secondary tuned by C1. The oscillator circuit consists of oscillator coil L9 with tapped sections of L10 through L13 in series between the tap and the negative side of the oscillator filament. C2 is the oscillator tuning capacitor with a 560- $\mu\text{f}$  padder in series.

On the 3.0–9.5-mc band, the antenna primary is composed of L1, L6, and L8, the broadcast-band secondary, in series. L4 and L5 are connected in series and used as the secondary. The circuit is tuned by the full capacitance range of C1. In the oscillator circuit, the inductance is reduced by cutting out L9, increasing the padding capacitance to .003  $\mu\text{f}$ , and switching in trimmer capacitors.

In the next three tuning ranges, the 9.5–22.5-mc section of the short-wave spectrum (frequency ratio about 2.36 to 1) is split into three overlapping bands, each having a frequency range of considerably less than 2 to 1. The oscillator inductance for each band is reduced by progressively cutting out portions of the series-connected inductors until only L13 is left. New padders and trimmers are switched in to control the maximum and minimum capacitance across the inductances.

On band 3, the antenna primary is the same as on band 2. The secondary is tuned to the higher range by short-circuiting L4 and adding a 47- $\mu\text{f}$  padder capacitor in series with C1. On band 4, L1 is used alone as the antenna primary. The tuned secondary consists of L2 and L3 in series tuned by C1 and

the 47- $\mu\text{f}$  padder. For band 5, L3 is shorted out and a new (66- $\mu\text{f}$ ) padder is connected in series with C1.

### Permeability-tuned circuits

The circuit in Fig. 5 is used in many Airline and Belmont sets. It is a combination of the basic circuits shown in Figs. 1-d and 1-e. The tuning arrangement for the broadcast band—a conventional permeability-tuned arrangement—is not shown. The main tuning slugs are in the cores of the 9-mc (31-meter) antenna, r.f., and oscillator coils. When tuning in the 49-meter (6-mc) band, the required inductances are made up by connecting the 6-mc inductor in series with the 9-mc tuned coils. For 31 meters, the 6-mc coils are shorted out. On bands 3 and 4 (11.4–12.1 and 14.9–15.4 mc) the 6-mc coils remain shorted out and the 12- or 15-mc shunt padding inductors are connected in parallel with the 9-mc coils to lower the inductances to the proper values.

### RCA Microtune circuit

The Microtune bandspread system uses permeability tuning to spread one or more short-wave bands on all-wave sets which employ variable capacitance on bands where the frequency ratio is approximately 3 to 1. The circuits in the model 5QA5 are shown in Fig. 6.

TABLE I

Band (meters)	Range (mc)	Bandwidth
49	5.90—6.30	400 kc
41	7.03—7.50	470 kc
31	9.29—9.80	510 kc
25	11.5—12.2	700 kc
19	14.8—15.7	900 kc
16	17.4—18.5	1.1 mc
13	20.8—22.4	1.6 mc

On the first three ranges, the variable-capacitance-tuned circuits are conventional. Permeability tuning is used in the 9.5–12-mc and 15.1–17.9-mc bands. The tuning slugs in the cores of the 9.5–12-mc coils are ganged to the main tuning control and dial. When these coils are switched into the circuit, the variable tuning capacitors are switched out. The highest frequency bands are tuned by shunting the 19–16-meter coils across the slug-tuned coils which are used alone for the 31–25-meter range. This bandspread system is similar to that in Fig. 5. END

## DECADE RESISTANCE BOX

The most common decade resistance substitution boxes require nine or ten resistors and a tap switch for each range. The resistor decade shown in the diagram uses only 20 resistors and 5 5-prong sockets to cover the range from 100 to 9,999,900 in steps of 100 ohms. Short jumpers fitted with phone tips are used to connect the required resistors in series. Each figure in the desired resistance value is obtained by using a jumper to select the resistance corresponding to it. If the figure is zero, bypass that particular decade.

The decade box is easy to use. No

chart is required. Assuming that the desired resistance is 7,468,500 ohms, we take the following steps to obtain the exact value:

1. Test lead into 1A (the letter indicates the socket and the number indicates its pin.)

2. Jumper from 4A to 1B.
3. Jumper from 3B to 2C.
4. Jumper from 4C to 2D.
5. Jumper from 5D to 3E.
6. Test lead into 5E.

It's easy when you get the hang of it.—C. W. Griffie

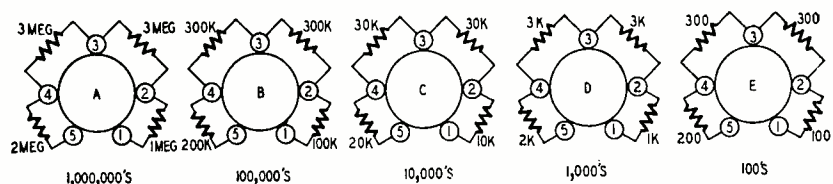



# Check these ADVANTAGES FOUND Only in HEATHKITS

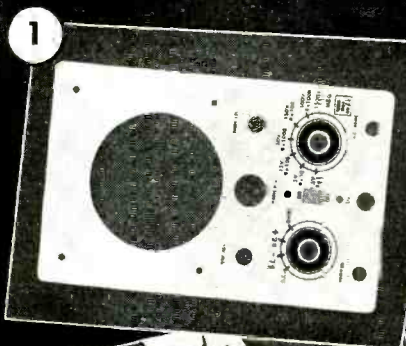

#### 1. Baked Enamel Lifetime Finish Panels

— Oven baked finishes for maximum durability and freedom from mars, scratches and discoloration. Panels that can really take service shop and laboratory abuse.

2. **Save Money** — You save all expensive factory wiring costs when you build your own. And, direct factory to customer sales eliminate all middle man profits. You can have a complete Heathkit laboratory or service shop for what one or two pieces of ready built equipment cost.

3. **Modern Styling** — New "fitted panels" and formed cabinets with rounded corners present a smart, professional appearance. Dignified appearance for prestige.

4. **Quality Components Used Throughout** — Heathkits use well known, time and quality tested components such as Simpson, Chicago Transformer, Wilkor, Allen-Bradley, Altec-Lansing, Centralab, Cinch, Oak, Grigsby-Allison, Mallory and many others.

5. **Extensive Factory Facilities** — Shearing, punching, forming, spot welding, etc. is done right in our own plant — controlled production for highest quality and less cost to you.

6. **Extensive and careful engineering** — A staff of engineers working in a modern, well equipped laboratory carefully develop Heathkits according to highest engineering practices. Your assurance of accurate, up to the minute instruments.

7. **Complete Kits** — All the parts are right in the kit — you get all tubes, controls, transformers, meters — everything — no other components to buy. And no cutting, punching, or painting necessary — it's all done for you. Heathkits go together easily and smoothly.

8. **Only Complete Line** — Over 30 kits available — Heathkits form the only complete line of kit-form test equipment on the market. Kits for hams, engineers, service men, schools and audio enthusiasts.

9. **Detailed, Complete Instruction Manuals** — Comprehensive manuals tell you exactly how to build your Heathkit. Manuals contain easy-to-follow instructions, clear, large pictorials, schematic, detail drawings, etc. They make construction easy, fun, and educational.

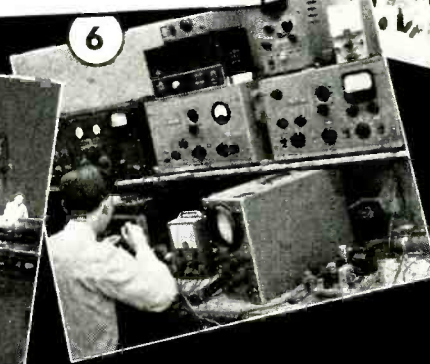
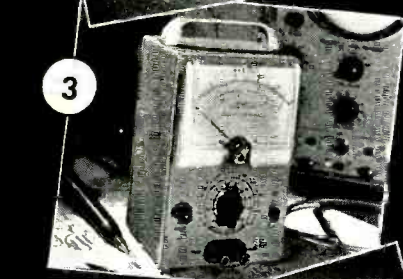
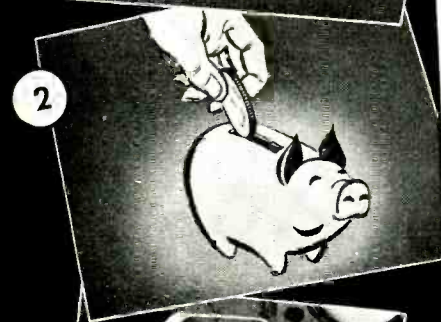
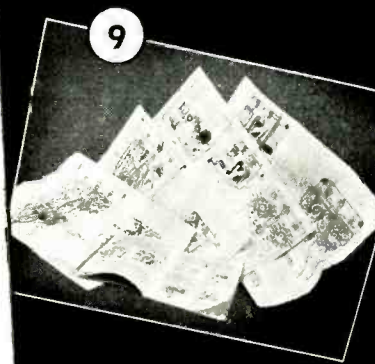

## Nine New Heathkits This Year!

EXPORT AGENT  
ROCKE INTERNATIONAL CORP.  
12 E. 40th ST.  
NEW YORK CITY 16  
CABLE APLAR N Y

# The HEATH COMPANY

... BENTON HARBOR 20, MICHIGAN

# NEW *Heathkit* "Q" METER KIT

• A HIGH QUALITY Q METER AT LOW COST.

MODEL QM-1

SHIPPING  
WT. 12 LBS.

**\$39.50**

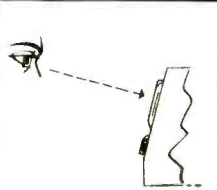
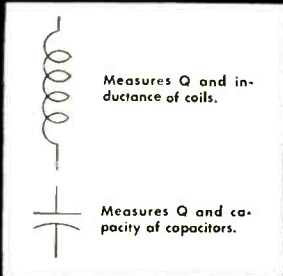

Slant face cabinet for ease in reading the meter.



• First Q METER within the price range of all.

• Read Q's of 0-500 directly on calibrated scale.

• Stable oscillator supplies R.F. frequencies of 150 kc to 18 megacycles.

• Calibrated capacitor with range of 40 mmf to 450 mmf with vernier of  $\pm 3$  mmf.

• Simple, easy operation.

• Can be used to measure small inductances or capacitors.

• Measures Q of condensers, RF resistance and distributed capacity of coils.

• Measures capacity by substitution, capacity by resonance, inductance by resonance.

• Slanted panel for convenient operation.

Another outstanding example of progressive HEATHKIT engineering. Now a highly desirable Q METER within the price range of all laboratories, schools and experimenters. No longer is it necessary to deny yourself the many measurement advantages offered by this instrument.

Use the new HEATHKIT Q METER for the following simple basic measurements: capacity by substitution, capacity by resonance, inductance by resonance and Q at the OPERATING frequency all can be read on the calibrated scales. The method used to obtain information regarding the Q of condensers, RF resistance, distributed capacity in coils, etc., is only slightly more involved. In the HEATHKIT Q METER, the generated RF signal is coupled through a cathode follower and injected across a low impedance condenser which is included in the resonant circuit under test. Large  $4\frac{1}{2}$ " 50 microampere Simpson meter reads Q directly. The resonating condenser and vernier condenser are calibrated in mmf for substitution method capacity tests. The resonating condenser is also calibrated in effective capacity for resonance tests. The inductance calibration serves for rapid determination of the approximate inductance of a coil. The HEATHKIT Q METER has a generator frequency range of 150 kc to 18 megacycles. Vernier capacity covers  $\pm 3$  mmf and the resonating condenser is calibrated from 40 mmf to 450 mmf actual capacity or 40 mmf to 350 mmf effective capacity. Meter reads Q directly up to 250. Higher and lower full scale readings can be obtained by varying the injection voltage levels.

The entire kit consists of 12AT7, 6AL5, 6C4, OD3 and 6X5 tubes, 50 microampere Simpson meter, power transformer, cabinet and all other parts necessary for construction as well as instructions for assembling, testing and operation of the completed instrument.

## *Heathkit* DECADE RESISTANCE KIT

The HEATHKIT DECADE RESISTANCE KIT is widely used by schools, experimenters and laboratories because of the extremely wide resistance range offered and the useful, dependable service provided. The DECADE consists of 5 rotary 2 deck ceramic wafer switches with silver plated contacts and twenty 1% precision resistors in a circuit which provides the resistance range of 1 ohm to 99,999 ohms in 1 ohm steps. The HEATHKIT DECADE RESISTANCE KIT is simple to construct and is housed in a beautiful polished birch cabinet with an attractive panel. The DECADE will furnish years of accurate trouble-free service.

Individual decade sections of above can be purchased separately for special applications.



MODEL DR-1  
SHIPPING  
WT. 4 LBS.

**\$19.50**

## *Heathkit* DECADE CONDENSER KIT

Extremely useful in all experimental and design work such as determination of condenser values for: compensating networks, filters, bridge impedances, tuned circuits, etc. Uses all precision silver mica condensers within  $\pm 1\%$  accuracy. Values run in three decades from 100 MMFD to 0.111 MFD in steps of 100 MMFD. Smooth acting, positive detent, highest quality ceramic wafer switches make all capacitor values easy to set up and keep losses to a minimum. Low loss dielectric terminal board mounts on outside of panel for easy cleaning. Heathkit binding posts accommodate a wide variety of test leads. Comes complete with all parts, including polished birch cabinet.

Individual decade sections of above can be purchased separately.

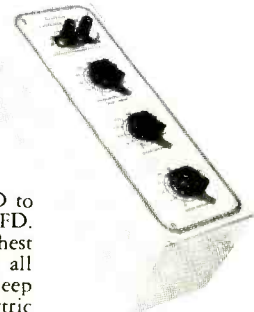

MODEL DC-1  
SHIPPING  
WT. 4 LBS.

**\$16.50**

EXPORT AGENT  
ROCKE INTERNATIONAL CORP.  
12 E. 40th ST.  
NEW YORK CITY (16)  
CABLE: ARIB-N.Y.

**The HEATH COMPANY**

**... BENTON HARBOR 20, MICHIGAN**



# NEW *Heathkit* OSCILLOSCOPE KIT

• NEW WIDE BAND VERTICAL AMPLIFIER  $\pm 2$  DB 10 CYCLES TO 1 MC.

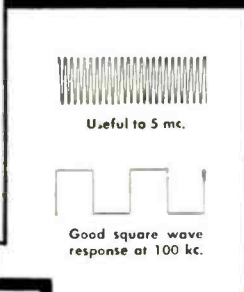
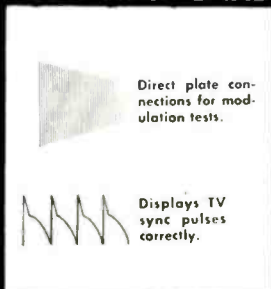

MODEL O-8

SHIPPING  
WT. 29 LBS.

**\$43.50**



• New wider band vertical amplifier  $\pm 2$  db from 10 cycles to 1 megacycle useful to over 5 megacycles.

• High sensitivity in vertical amplifier. .025 volts RMS per inch deflection.

• New 3 step input attenuator input ranges X1, X10, X100.

• New 5CP1 intensifier type tube for greater brilliance.

• Terminal board and rear cabinet opening provisions for direct connections to deflecting plates.

• Newly styled formed and ventilated aluminum cabinet.

• Wide band sweep generator, 15 cycles to over 100 kc. Will synchronize with 5 megacycle signal.

• 10 tube circuit featuring push pull operation of vertical and horizontal amplifiers.

• Internal synchronization on either positive or negative peaks.

• Reproduces faithfully the front and back porches of TV sync pulses. Excellent square wave reproduction to over 100 kc.

• Optional Intensifier kit available for 2200 volt operation.

Proudly announcing the new 1953 HEATHKIT Model O-8 OSCILLOSCOPE featuring the finest performance ever offered in this extremely popular kit instrument. Improved wider band vertical amplifier featuring a new 3-step input attenuator affording smooth control of the excellent .025 volts per inch vertical sensitivity. Possibility of overloading the vertical input circuit is minimized. Greater band width in the vertical channel is a decided advantage to TV service men. Permits clear observation of all TV sync pulse detail and excellent square wave reproduction over 100 kc. 5CP1 intensifier type CR tube provides a brilliant trace with normal accelerating voltages. A handsome, ventilated cabinet with smooth rounded corners and a snug fitting drawn panel adds to the smartly styled professional appearance. Longer life is assured through cooler instrument operation. Push pull output stages in both vertical and horizontal amplifiers for balanced deflection of the spot. All of the many fine features of the previous model have been retained. Rear cabinet access to terminal board for direct connection to CR plates. The entire kit of all 10 tubes, parts, cabinet and panel as well as detailed construction manual for assembly and operation of the instrument included.

**INTENSIFIER KIT:** For extreme trace brilliance in special applications such as photography, group demonstrations or operation in brightly lighted areas an optional Intensifier kit providing 2200 volt operation of the CR tube is available. Kit includes high voltage filter condenser, high voltage selenium rectifier, etc. \$7.50.



*Heathkit*

SCOPE DEMODULATOR PROBE KIT

Trouble shooting or aligning TV, RF, IF and video stages requires demodulation of high frequency signals before Oscilloscope observation. The HEATHKIT SCOPE DEMODULATOR PROBE KIT was specifically developed for this application. Kit consists of a probe housing, crystal diode detector circuit, shielded cable and spade lugs. Assembly is simple and the probe will quickly prove its usefulness as an Oscilloscope accessory.

No. 337  
SHIP. WT. 1 LB.  
**\$4.50**

## NEW *Heathkit* VOLTAGE CALIBRATOR KIT

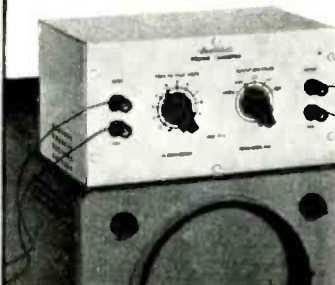

MODEL VC-1  
SHIPPING  
WT. 5 LBS. **\$9.50**

Use the Heathkit Voltage Calibrator with your oscilloscope to measure peak-to-peak TV complex waveshapes. TV manufacturer's specifications indicate correct peak-to-peak voltages and this kit will permit making these important measurements.

A big help to engineers in circuit work. Makes peak-to-peak voltage measurements of complex waveshapes of all kinds. Flat topped semi-square wave output of calibrator assures fast and easy measurement of any voltage between .01 and 100V peak-to-peak.

The Voltage Calibrator can remain connected to your oscilloscope at all times for instant use. "Signal" position connects signal under study directly through calibrator and into scope input circuit for direct observation. Eliminates transferring leads from calibrator. A wonderful scope accessory.

## *Heathkit* ELECTRONIC SWITCH KIT

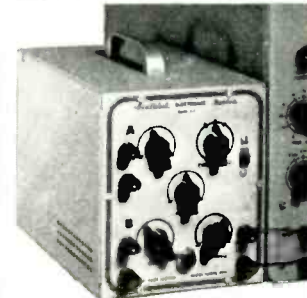

MODEL S-2  
SHIPPING  
WT. 11 LBS.

A few dollars spent for this accessory will increase the usefulness of a scope immeasurably. An electronic switch will open up a whole new field of scope applications for you. The S-2 allows TWO SIGNALS to be observed at the SAME TIME — this important feature allows you to immediately spot phase shift, clipping, distortion, etc. The two signals under observation can be superimposed or separated for individual study. Each signal input has an individual gain control for properly adjusting scope trace patterns. Has both coarse and fine frequency controls for adjusting switching time. Multivibrator switching frequency is from less than 10 cps to over 2000 cps in three overlapping ranges. Kit comes complete including 5 tubes, power transformer, all controls, instruction manual, etc. Every scope owner should have one!

**\$19.50**

REPORT AGENT  
ROCKE INTERNATIONAL CORP.  
13 E. 40th ST.  
NEW YORK CITY (16)  
CABLE: ARLAB-N.Y.

*The* **HEATH COMPANY**

... BENTON HARBOR 20, MICHIGAN

# Heathkit VACUUM TUBE VOLT METER KIT

• NEW 1½ VOLT RANGE ON 1953 VTVM.

MODEL V-6

SHIPPING WT., 7 LBS.

**\$24.50**

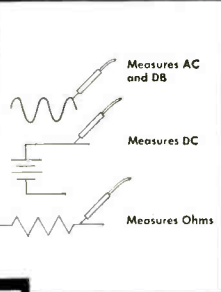
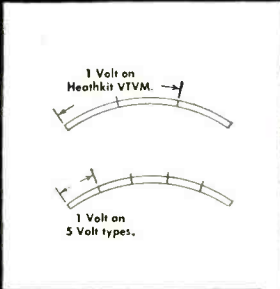
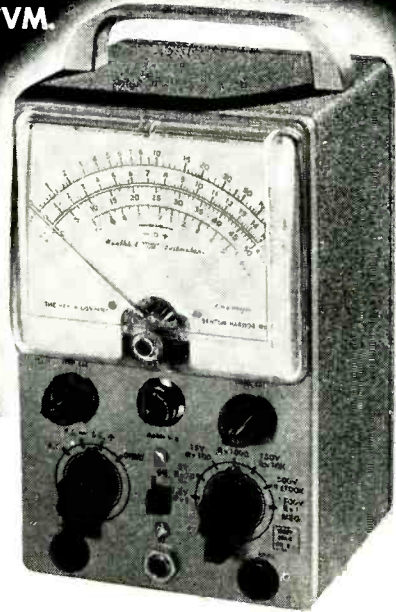

- New 1½ volt low range gives over 2" of scale per volt instead of less than ¾" found on 5 volt range type.
- Increased accuracy due to expanded scales.
- New 1500 volt DC high range gives 50% greater coverage.
- Seven ranges in all. 1½, 5, 15, 50, 150, 500 and 1500 volts DC (1000 volts maximum AC only).
- Provides proper service ranges 150 volts for AC DC work and 500 volts for AC type service.
- High input impedance, 11 megohms minimizes circuit loading.
- Variety of accessory probe kits available.
- 1% precision resistors in multiplier circuits.
- 200 microampere Simpson meter.
- Center scale zero adjust.
- Transformer operated.
- Test leads included.
- New cabinet styling.
- Large, clearly marked meter scales indicate ohms, AC volts, DC volts and DB.

The 1953 Heathkit V-6 VTVM has improved ranges! The lowest range has been moved way down to 1.5V full scale. This gives 3½" of actual scale length for the 1.5V covered — that's 2½ inches per volt! Now you can make your low level measurements faster and with greater accuracy.

And the upper range has been moved up. Readings up to 1500V DC can be readily made with new, improved VTVM — plus readings up to 1000V on AC. Higher ranges for extended use.



New vertical chassis mounting gives added chassis space for really easy wiring — no tight corners to worry about. Uses only highest quality components throughout. Simpson 200 microampere meter movement combined with 1% precision resistors in multiplier circuit insure highly accurate and dependable readings.

AC and DC voltage ranges are 0-1.5V-5V-15V-50V-150V-500V-1500V (1000V max. reading on AC) — a total of seven ranges for convenient, accurate readings. Instrument also measures resistance from .1 ohm to over 1 billion ohms in seven handy ranges of RX1, X10, X100, X1000, X10K, X1 Meg., — all convenient multiples of 10 with no skips. Has Db scale in red for easy identification.

New panel has tough baked on enamel finish for freedom from scratches and maximum durability. Modern styled, formed, compact cabinet with rounded edges and crackle finish is truly handsome.

Comprehensive, detailed instruction manual with step-by-step instructions, figures, pictorials, etc. makes assembly a cinch.

Be sure and look over the special accessory VTVM probes below — for added usefulness.

<p><b>Heathkit R. F. PROBE KIT</b> SHIP. WT. 1 LBS. <b>\$5.50</b> No. 309 Extends RF range of HEATHKIT 11 megohm VTVM to 250 megacycles ± 10%.</p> 	<p><b>Heathkit 30,000 V. D.C. PROBE KIT</b> SHIP. WT. 2 LBS. <b>\$5.50</b> No. 336 Provides DC multiplication factor of 100 for any 11 megohm VTVM.</p> 	<p><b>Heathkit PEAK TO PEAK VOLTAGE PROBE KIT</b> SHIP. WT. 2 LBS. <b>\$6.50</b> No. 338 Reads on DC scale of any 11 megohm VTVM 5 kc to 5 megacycle range.</p> 
--	---	---

## NEW Heathkit BATTERY TESTER KIT

The new Heathkit Battery Tester measures all types of dry batteries between 1½ volts and 150 volts under actual load conditions. Readings are made directly on a three-color GOOD-WEAK-REPLACE scale that your customers can readily understand. Operation is extremely simple and merely requires that the leads be connected to the battery under test. Only one control to adjust in addition to a panel switch for A or B battery types.

The Heathkit Battery Tester features compact assembly. An accurate meter movement and wire wound control mount in the portable, rugged plastic case.

Use the BT-1 to check portable radio batteries, hearing aid batteries, lantern batteries and photo flash gun batteries.

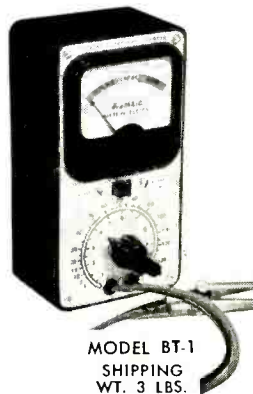

MODEL BT-1  
SHIPPING WT. 3 LBS.

**\$7.50**

## Heathkit AC VACUUM TUBE VOLT METER KIT

A new AC VTVM that makes possible those sensitive AC measurements required by laboratories, audio enthusiasts and experimenters. Ten full scale ranges of .01, .03, .1, .3, 1, 3, 10, 30, 100 and 300 volts RMS. 10 DB ranges from -52 to +52 DB. Frequency response within 1 DB from 20 cycles to 50 kc. Simpson 200 microampere meter with large plainly marked meter scales. Precision multiplier resistors. Two amplifier stages using miniature tubes. A unique bridge rectifier meter circuit and a clean layout of parts. Order the AV-2 today and become acquainted with the interesting possibilities offered by this instrument.

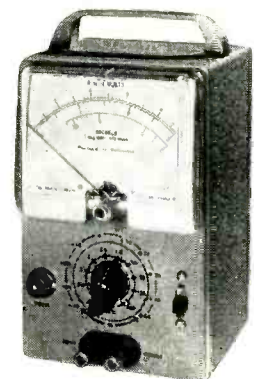

MODEL AV-2  
SHIPPING WT. 5 LBS.

**\$29.50**

EXPORT AGENT  
ROCKE INTERNATIONAL CORP.  
13 E 40th ST  
NEW YORK CITY (16)  
CABLE ARSAB N Y

**The HEATH COMPANY**

... BENTON HARBOR 20, MICHIGAN



# NEW *Heathkit* GRID DIP METER KIT

• CONVENIENT ONE HAND OPERATION.

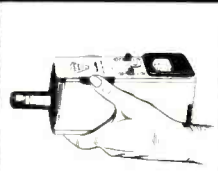
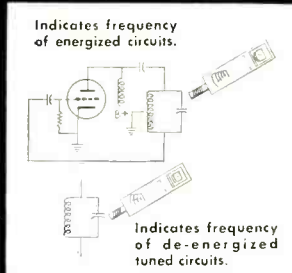

Complete unit easily held and operated with one hand.

MODEL GD-1

SHIPPING  
WT. 4 LBS.

**\$19<sup>50</sup>**



- New GRID DIP METER with assembled calibrated coils.
- Uses quality Simpson 500 microampere meter.
- One hand operation, extremely compact. Only 2½" wide by 3" high by 7" long.
- Variable meter sensitivity control.
- Uses newest type 6AF4 high frequency triode in a Colpitts oscillator circuit.
- Continuous coverage from 2 megacycles to over 250 megacycles in 6 ranges.
- Head phone monitoring jack.
- AC power transformer operated for maximum safety.

Here is the GRID DIP METER KIT you have been asking for. This new HEATHKIT instrument is compact, highly sensitive and easy to use. Housed in a handsome formed aluminum cabinet—rounded corners—durable oven baked finish on panel and cabinet. The entire instrument can be easily held and operated in one hand, tuning accomplished with the thumb wheel drive. This excellent design feature leaves the other hand entirely free for making circuit adjustments. The instrument with many applications — with oscillator energized, use it for finding the resonant frequency of tuned circuits, locating parasitics, determining characteristics of filter circuits, roughly tuning transmitter stages with power off, and neutralizing transmitters. Useful in TV and radio repair work for alignment of traps, filters, IF stages, peaking and compensation networks within the 2 to 250 megacycle range. With the oscillator not energized, the instrument acts as an absorption wave meter and indicates the frequency of radiating power sources. Locates spurious oscillations, as a relative indication of power in various transmitter stages, etc. Phone jack permits monitoring of AM transmitter for determination of radiated hum, audio quality, etc. (Head phones not included). Complete kit includes plug-in coils, tube, all necessary parts and detailed assembly and instruction manual.

## *Heathkit* IMPEDANCE BRIDGE KIT

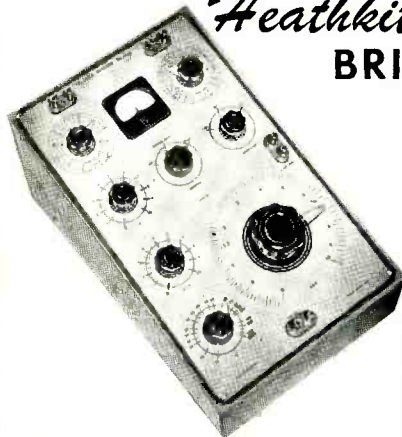

MODEL 1B-1B  
SHIPPING  
WT. 15 LBS.

**\$69<sup>50</sup>**

The HEATHKIT IMPEDANCE BRIDGE is especially useful in educational training programs, industrial laboratories and for experimental work. Use it for measuring AC and DC resistance value of resistors,

determination of condenser capacitance and dissipation factor, finding coil inductance and storage factor, electrical measurements work, etc. Quality components: GR 1000 cycle hummer, GR main control, Mallory ceramic water silver plated contact switches, 1/2% precision resistors, etc. The basic circuit is a self powered, 4 arm bridge. Choice of Wheatstone, Capacitance comparison, Maxwell or Hay bridge circuits. Resistance from 10 milliohm to 10 megohm. Capacitance 10 mmf to 100 mfd. Inductance 10 microhenry to 100 henries. Dissipation factor .002 to 1. Storage factor (Q) 1 to 1000. The IMPEDANCE BRIDGE has provisions for external generator use for measurement at other than the 1000 cycle level. Take the guess work out of electrical measurements. The HEATHKIT IMPEDANCE BRIDGE mounted in a beautiful polished birch cabinet with large easy reading panel calibrations will furnish years of accurate, trouble free measurement service.

## *Heathkit* HANDITESTER KIT

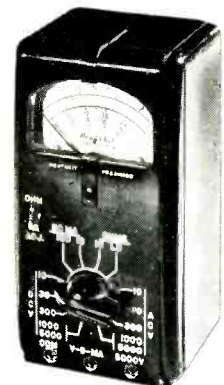

MODEL M-1  
SHIPPING  
WT. 3 LBS.

**\$13<sup>50</sup>**

The HEATHKIT Model M-1 HANDITESTER fulfills requirements for a portable volt ohm milliammeter. This kit features precision 1% resistors, 3 deck switch for trouble free mounting of parts, specially designed battery bracket, smooth acting ohms adjust control, beautiful molded bakelite case and a 400 microampere meter movement. 5 convenient AC and DC voltage ranges as follows: 10 - 30 - 300 - 1000 - 5000 volts. Ohms ranges 0 - 3000 and 0 - 300,000. DC milliampere ranges 0 - 10 milliamperes and 0 - 100 milliamperes. The instrument is easily assembled from complete instructions and pictorial diagrams. Test leads are included. Carry the HEATHKIT M-1 HANDITESTER in your tool box at all times for those simple jobs and eliminate that extra trip for additional testing equipment.

EXPORT AGENT  
ROCKE INTERNATIONAL CORP.  
125 E. 40th ST.  
NEW YORK CITY (16)  
CABLE: ARJAE-N.Y.

*The* **HEATH COMPANY**

... BENTON HARBOR 20, MICHIGAN

NEW *Heathkit*

# AUDIO GENERATOR KIT

• RANGE EXTENDED TO 1 MEGACYCLE

MODEL AG-8

SHIPPING  
WT. 16 LBS.

**\$29.50**

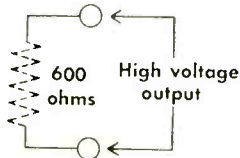
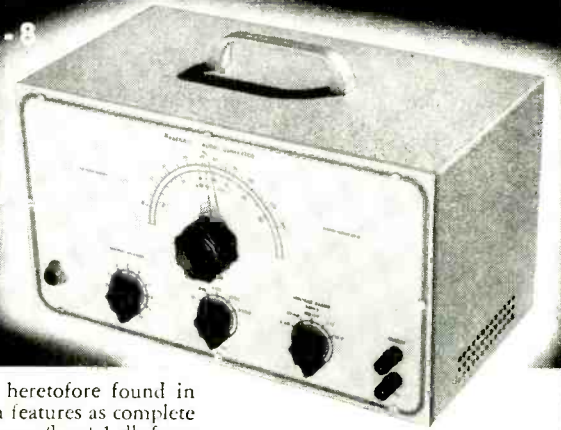

Low impedance output  
High voltage output



Sine wave output  
from 20 cycles to 1  
megacycle.

- Improved design — new low price.
- Frequency coverage in five ranges from 20 cycles per second to 1 megacycle.
- Response flat 1 DB from 20 cycles to 400 kilocycles. Down 3 DB at 600 kilocycles. Down only 8 DB at 1 megacycle.
- Five calibrated output voltage ranges, continuously variable 1 mv, 10 mv, 100 mv, 1 v, 10 v.
- Low impedance output circuit. 600 ohms.
- Distortion less than .4 of 1% from 100 cycles per second through the audible range.
- New HEATHKIT universal type binding posts.
- Durable infra-red baked enamel panel.
- Transformer operated for safe operation.
- Sturdy, ventilated steel cabinet.

A new Audio Generator with features heretofore found in only the most expensive generators. Such features as complete coverage from 20 cycles to 1 Mc — response flat  $\pm 1$  db from 20 cycles to 400 Kc, down 3 db at 600 Kc and down only 8 db at 1 Mc.

And it has calibrated output . . . Calibrated continuously variable and step attenuator output controls allow you to easily set calibrated output voltage. Moreover, distortion is less than .4 of 1% from 100 cps through the audible range.

Oscillator section consists of a two stage resistance coupled amplifier (6SJ7 and 6AK6) utilizing both positive and negative feedback for oscillator operation and reduction of distortion. Oscillator section drives a cathode follower output power amplifier (6AK6) which isolates the oscillator from variations in load and presents a low impedance output (600 Ohms). Power supply is transformer operated and utilizes 6X5 rectifier with 2 sections of RC filtering.

An unbeatable dollar value — for here is an audio generator with wide frequency coverage, excellent frequency response, stepped and continuously variable calibrated output, high signal level, low impedance output, and low inherent distortion.

## *Heathkit* AUDIO FREQUENCY METER KIT

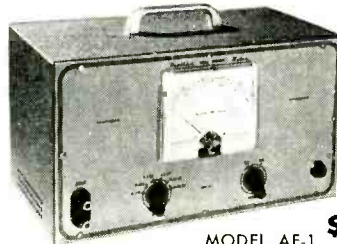

MODEL AF-1

**\$34.50**

SHIPPING  
WT. 15 LBS.

The HEATHKIT AUDIO FREQUENCY METER provides a simple and easy way to check unknown audio frequencies from 10 cycles to 100 kc between 3 and 300 volts RMS. The instrument features 7 ranges for accuracy and wide coverage. The meter itself has a quality 200 microampere Simpson movement and large clearly marked scales. The AUDIO FREQUENCY METER is transformer operated and features a voltage regulator tube to maintain constant plate voltage on the second stage. Kit supplied complete with all necessary construction material and a detailed construction manual.

## NEW *Heathkit* AUDIO OSCILLATOR KIT

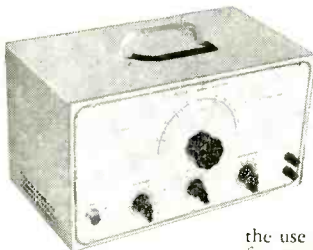

MODEL AO-1  
SHIPPING  
WT. 14 LBS.

**\$24.50**

A new Audio Oscillator with both sine and square wave coverage from 20 to 20,000 cycles . . . An instrument designed to completely fulfill the needs of the audio engineer and enthusiast — Has numerous advantages such as high level output (up to 10V obtainable across the entire range), distortion less than .6%, and low impedance output.

Special design features include the use of a thermistor in the second amplifier stage for keeping the output essentially flat across the entire range.

A cathode coupled clipper circuit produces good, clean, square waves with rise time of only 2 microseconds. Oscillator section uses 1% precision resistors in range multiplier circuit for greatest accuracy.

You'll like the operation of this fine new kit.

## *Heathkit* SQUARE WAVE GENERATOR KIT

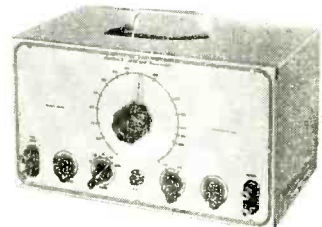

MODEL SQ-1  
SHIPPING  
WT. 14 LBS.

**\$29.50**

The HEATHKIT SQUARE WAVE GENERATOR is an excellent square wave frequency source with wide range coverage from 10 cycles to 100 kc continuously variable. This feature makes it useful for TV and wide band amplifier work as well as audio experimentation. The output voltage is continuously variable between 0 and 20 volts. The circuitry consists of a multivibrator stage, a clipping and squaring stage and a cathode follower low impedance output stage. The power supply is transformer operated and utilizes a full wave rectifier circuit with two sections of filtering. Another excellent HEATHKIT value at this remarkable low price. Kit includes all necessary construction material as well as complete instruction manual for assembly and operation.

EXPORT AGENT  
ROCKE INTERNATIONAL CORP.  
112 E. 10th ST.  
NEW YORK CITY (16)  
CABLE: ARLES N.Y.

*The* **HEATH COMPANY**

BENTON HARBOR 20, MICHIGAN



# NEW *Heathkit* VISUAL-AURAL SIGNAL TRACER KIT

• NEW NOISE LOCATOR AND WATTMETER CIRCUITS.

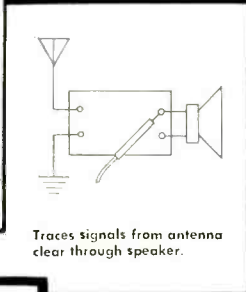
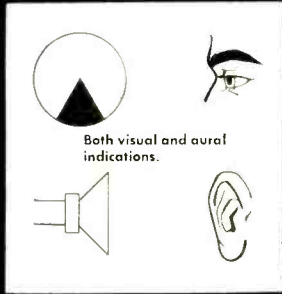

MODEL T-3

SHIPPING  
WT. 8 LBS.

**\$2250**



- Permits visual signal observation as well as aural operation.
- Two separate input channels.
- Tremendous RF channel sensitivity. Adequate for actual signal detection at receiver input.
- Separate high gain RF and low gain audio channels.
- A unique and useful noise locator circuit.
- Built-in calibrated wattmeter.
- Two separate shielded probes for RF and audio application.
- Additional test leads supplied.
- Substitution test speaker and output transformer eliminates necessity for speaker removal in service work.
- Utility amplifier. Check record changers, tuners, microphones, instrument pickups, etc.
- VTVM and Scope panel terminals.
- 5 tube transformer operated circuit.

The new HEATHKIT VISUAL AURAL SIGNAL TRACER represents one of the most convenient and useful instruments the service man can use in AM, FM and TV service work. The electron ray beam indicator constantly monitors both input channels for visual observation of the signal. Now, see and hear the signal level for easier estimation of signal strength and gain per stage in a receiver circuit. Separate high gain channel and special shielded demodulator probe for RF circuit work. Low gain channel for audio circuit investigation and for use as a noise locator. In this feature, approximately 200 volts DC is applied to a suspected circuit component and the action of the voltage in the component can be seen and heard to determine satisfactory operation. This feature alone will prove tremendously helpful in locating the source of objectionable noises in coils, transformers, resistors, condensers, cold solder joints, controls, etc. A convenient wattmeter permits rapid preliminary check for voltage distribution circuit breakdown as well as transformer failures. Use the T-3 as a universal test speaker and substitution transformer and save service time by eliminating the necessity for speaker removal on every service call. Additional service uses are: as a utility amplifier for checking the output of record changers, tuners, microphones, instrument pickups, etc. Separate panel terminals permit utilization of other shop equipment such as your Oscilloscope or VTVM. Entire kit supplied complete with 5 tubes, all necessary construction material along with a detailed step by step instruction manual for the assembly and operation of the instrument.

## NEW *Heathkit* CONDENSER CHECKER KIT

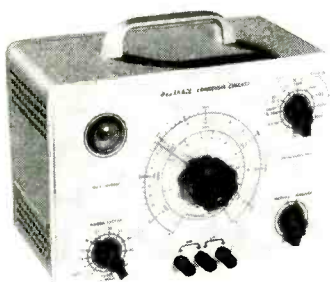

MODEL C-3  
SHIPPING  
WT. 7 LBS.

**\$19<sup>50</sup>**

Announcing the new improved Model C-3 HEATHKIT CONDENSER housed in a new smartly styled professional appearing cabinet featuring rounded corners and snug fitting drawn panel. Adequate provisions for ventilation insure longer instrument life through cooler operation. Use the C-3 to accurately measure those unknown condenser and resistor values. All readings of condensers and resistors are read directly on the calibrated scales. Range of condenser measurements is from .00001 mfd to 1000 mfd. Calibrated resistance measurements can be made from 100 ohms to 5 megohms. A leakage test with a choice of 5 DC polarizing voltages will quickly indicate condenser operating quality under actual voltage load conditions. The spring return leakage test switch automatically discharges the condenser under test and eliminates shock hazard. An electron ray beam indicator tube is used in a new leakage test circuit for added sensitivity. The instrument is transformer operated for safety and will prove an extremely welcome addition to your shop equipment. The kit is furnished complete with all necessary parts, test leads and includes a step by step detailed construction manual for assembly and operation.

sure longer instrument life through cooler operation. Use the C-3 to accurately measure those unknown condenser and resistor values. All readings of condensers and resistors are read directly on the calibrated scales. Range of condenser measurements is from .00001 mfd to 1000 mfd. Calibrated resistance measurements can be made from 100 ohms to 5 megohms. A leakage test with a choice of 5 DC polarizing voltages will quickly indicate condenser operating quality under actual voltage load conditions. The spring return leakage test switch automatically discharges the condenser under test and eliminates shock hazard. An electron ray beam indicator tube is used in a new leakage test circuit for added sensitivity. The instrument is transformer operated for safety and will prove an extremely welcome addition to your shop equipment. The kit is furnished complete with all necessary parts, test leads and includes a step by step detailed construction manual for assembly and operation.

## *Heathkit* TV ALIGNMENT GENERATOR KIT

MODEL TS-2  
SHIPPING  
WT. 20 LBS.

**\$39<sup>50</sup>**

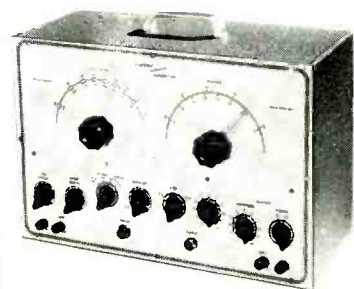

Here is an excellent TV ALIGNMENT GENERATOR designed to do TV service work quickly, easily and properly. The Model TS-2 when used in conjunction with an Oscilloscope provides a means of correctly aligning TV receivers. The instrument furnishes a frequency modulated signal covering in 2 bands the range of 10 to 90 megacycles and 150 to 230 megacycles. An absorption type frequency marker covers from 20 to 75 megacycles in 2 ranges; therefore you have a simple, convenient means of checking IF's independent of oscillator calibration. Sweep width is variable from 0 to 12 megacycles. Other excellent features are horizontal sweep voltage controlled with a phasing control — both step and continuously variable attenuation for setting the output signal to the desired level — a convenient stand by switch — and blanking for establishing a single trace with a base reference level. Make your work easier, save time and repair with confidence. Order your HEATHKIT TV ALIGNMENT GENERATOR now.

EXPORT AGENT  
ROCKE INTERNATIONAL CORP.  
13 E. 40TH ST.  
NEW YORK CITY (16)  
CABLE AREA-N.Y.

*The* **HEATH COMPANY**

... BENTON HARBOR 20, MICHIGAN

# Heathkit TUBE CHECKER KIT

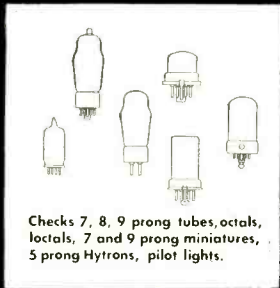

Checks 7, 8, 9 prong tubes, octals, loctals, 7 and 9 prong miniatures, 5 prong Hytrons, pilot lights.

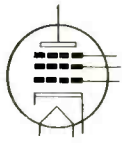

Checks for opens, shorts, emission, filament and filament tap continuity.

MODEL TC-1

SHIPPING  
WT. 12 LBS.

**\$29.50**

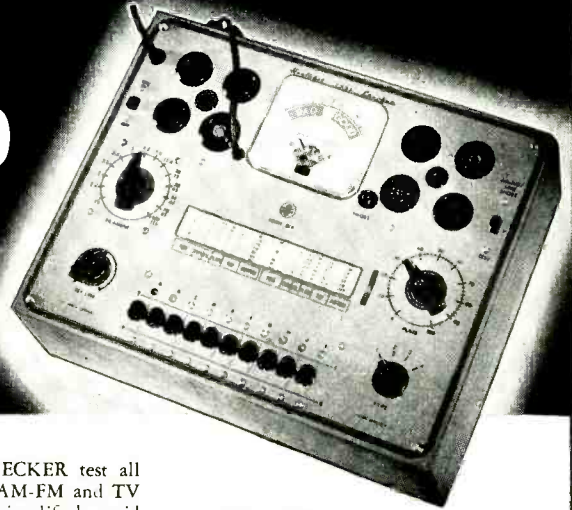

- Beautiful counter type birch cabinet.
- 4½" Simpson 3 color meter.
- Simplified setup procedure.
- Built-in gear driven roll chart.
- Checks emission, shorted elements, open elements and continuity.
- Complete protection against obsolescence.
- Sockets for every modern tube.
- Blank for new types.
- Individual element switches.
- Contact type pilot light test socket.
- Line adjust control.

With the HEATHKIT TC-1 TUBE CHECKER test all types of tubes commonly encountered in AM-FM and TV receiver circuits. Test setup procedure is simplified, rapid and flexible. Tube quality is read directly on a beautiful 4½" Simpson three color BAD - ? - GOOD scale that your customers can readily understand. Panel sockets accommodate 4, 5, 6 and 7 prong tubes, octals, loctals, 7 and 9 prong miniatures, 5 prong Hytrons, a blank socket for new tubes and a contact type socket for quick checking of pilot lights. Built-in gear driven roll chart for instant reference. Neon short indicator, individual three position lever switch for each tube element, spring return test switch, line set control to compensate for supply voltage variations. At this low price, no service man need be without the advantages offered by the HEATHKIT TUBE CHECKER.

## Heathkit TV PICTURE TUBE TEST ADAPTER

Use your HEATHKIT TUBE CHECKER with this new TV TEST ADAPTER to determine picture tube quality. Check for emission and shorts, independent of TV power supply. Consists of standard 12 pin TV tube socket, 4 feet of cable, octal socket connector and data sheet. Quickly prove TV picture tube condition to yourself and your customer.



No. 355  
Ship. Wt. **\$4.50**  
1 lb.



## Heathkit RESISTANCE SUBSTITUTION BOX KIT

MODEL RS-1  
SHIPPING  
WT. 3 LBS.

**\$5.50**

NEW HEATHKIT RESISTANCE SUBSTITUTION BOX KIT provides switch selection of any single one of 36 RTMA 1 watt 10% standard value resistors, ranging from 15 ohms to 10 megohms. This coverage available in 2 ranges in decades of 15, 22, 33, 47, 68 and 100. Housed in rugged plastic cabinet featuring new HEATHKIT universal type binding posts. The entire kit priced less than the retail value of the resistors alone.

## Heathkit BATTERY ELIMINATOR KIT

A clean 6 volt d-c supply source is definitely required for successful automobile radio servicing. Has a continuously variable d-c output from 0 to 8 volts. It can be safely operated at a steady 10 ampere level and will deliver up to 15 amperes for intermittent periods. The voltage output terminals are completely isolated from the chassis to accommodate additional service applications such as supplying bias voltages or d-c substitution voltages for battery operated tube filament circuits.

The output of the Battery Eliminator is constantly monitored by a d-c voltmeter and a d-c ammeter. The circuit features an automatic overload relay of self resetting type. For additional protection, a panel mounting fuse is provided. Build this kit in a few hours and pocket a substantial savings.

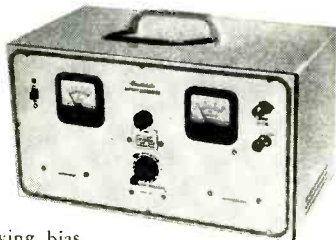

MODEL BE-3  
SHIPPING  
WT. 20 LBS.

**\$24.50**

## Heathkit VIBRATOR TESTER KIT

Repair time is valuable, and the Heathkit Vibrator Tester will save you hours of work. Instantly tells the condition of the vibrator under test—and the check is thorough and complete. Checks vibrator for proper starting, and the easy-to-read meter indicates the quality of output on large BAD-GOOD scales. Tests both interrupter and selfrectifier types of vibrators. Five different sockets for checking hundreds of vibrators.

Operates from any battery eliminator capable of delivering continuously variable voltage from 4-6V at 4 amps. The Heathkit BE-3 Battery Eliminator is ideal for operating this kit.

Faulty vibrators can be spotted within seconds and you're free to go on to other service jobs.

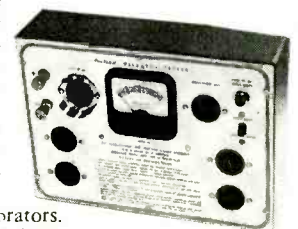

MODEL VT-1  
SHIPPING  
WT. 7 LBS.

**\$14.50**

EXPORT AGENT  
ROCKE INTERNATIONAL CORP.  
132 E. 40th ST.  
NEW YORK CITY (16)  
CABLE: ARIAS N.Y.

The **HEATH COMPANY**

BENTON HARBOR 20, MICHIGAN



# Heathkit SIGNAL GENERATOR KIT

MODEL SG-7

SHIPPING  
WT. 7 LBS.

**\$19<sup>50</sup>**



Modulated or unmodulated RF output.



400 cycle sine wave output.

- Step attenuated RF output.
- 6 to 1 vernier dial ratio.
- Turret mounted coil sub-assembly.
- Pre-calibrated and adjusted coils.
- Hartley RF oscillator circuit.
- Colpitts oscillator 400 cycle sine wave output.
- Modulated or unmodulated RF output.
- Frequency coverage on fundamentals 160 kc to 50 megacycles in five ranges. 51 megacycles to 150 megacycles on calibrated harmonics.
- RF output in excess of 100,000 microvolts.
- Audio output 1 1/2 to 2 volts.
- AC transformer operated.
- Professionally styled cabinet.
- Infra red baked enamel panel.

The new HEATHKIT Model SG-7 SIGNAL GENERATOR easily fulfills requirements for a controllable, modulated or unmodulated source of variable frequency. A convenient 400 cycle sine wave output is available for audio work. All RF oscillator coils are precision wound and adjusted to calibration before shipment thereby assuring maximum accuracy. The coils, band switch and tuning condenser all mount as a turret assembly so as to offer the advantage of short wiring leads and easy mounting of parts. The RF output circuit is of the low impedance type obtained by the use of cathode coupling to the output jacks. The level of RF output is varied by means of the RF step and RF output control. Use the HEATHKIT SG-7 as an RF signal source modulated or unmodulated for radio repair, laboratory work, experimental testing, 400 cycle sine wave audio testing, checking RF stages, alignment of both AM and FM IF stages, marker generator for TV alignment, etc. The kit is transformer operated and utilizes miniature tubes for ease in handling high frequency. Panel jacks and a convenient switching system permit either external or internal modulation. The entire kit is supplied complete with tubes and all necessary material as well as a detailed step by step instruction manual for the assembly and operation of the instrument.

## Heathkit INTERMODULATION ANALYZER KIT



MODEL IM-1  
SHIPPING WT.  
18 LBS.

**\$39<sup>50</sup>**

The HEATHKIT MODEL IM-1 is an extremely versatile instrument specifically designed for measuring the degree of interaction between two

signals caused by a specific piece of apparatus, or a chain of equipment. It is primarily intended for tests of audio equipment but may be used in other applications such as making tests of microphones, records, recording equipment, phonograph pickups and loud speakers. Use it for checking tape or disc recordings, as a sensitive AC voltmeter, as a high pass noise meter for adjusting tape bias, cutting needle pitch or other applications. High and low test frequency source, intermodulation section, power supply and AC voltmeter all in one complete unit. Percent intermodulation is directly read on three calibrated ranges, 30%, 10% and 3% full scale. Both 4 to 1 and 1 to 1 ratios of low to high frequencies easily set up. At this low kit price YOU can enjoy the benefits of Intermodulation analysis for accurate audio interpretations.

## Heathkit LABORATORY REGULATED POWER SUPPLY KIT



MODEL PS-2  
SHIPPING  
WT. 20 LBS.

**\$29<sup>50</sup>**

New HEATHKIT LABORATORY POWER SUPPLY provides continuously variable regulated DC voltage output

from 160 volts to 400 volts depending on load. Panel terminals supply separate 6.3 V. AC supply at 4 amperes for filament circuits. A 3 1/2" plastic cased panel mounted meter provides accurate metered output for either voltage or current measurements. Exceptionally low ripple content of .012% admirably qualifies the HEATHKIT LABORATORY POWER SUPPLY for high gain audio applications. Ideal for laboratory work requiring a reference voltage for meter calibration or for plotting tube characteristics. In service work, it can be used as a separate variable voltage supply to determine the desirable operating voltage in a specific circuit. Use it as a DC substitution voltage in trouble shooting TV circuits exhibiting symptoms of extraneous undesirable components in plate supply circuits. Entire kit, including all 5 tubes now available at this low price.

EXPORT AGENT  
ROCKE INTERNATIONAL CORP.  
13 E. 40th ST.  
NEW YORK CITY (16)  
CABLE: ARLAB-N.Y.

*The* **HEATH COMPANY**

... BENTON HARBOR 20, MICHIGAN

# Heathkit WILLIAMSON TYPE AMPLIFIER KIT

The HEATHKIT WILLIAMSON TYPE AMPLIFIER performance has been verified on the basis of critical listening tests and laboratory measurements by both music lovers and audio experts. Use this outstanding amplifier as the heart of your audio system for the fine musical reproduction that is the goal of every audio enthusiast. A new Peerless output transformer with additional primary taps permits ultra linear type circuitry, affording a peak power output of well over 20 watts. Quality of reproduction is instantly apparent and measurements actually bear out the superb performance. Frequency response  $\pm 1$ DB from 10 cycles to 100 kc allows reproduction of the highs and lows with equal crispness and clarity. Harmonic and intermodulation distortion both less than  $\frac{1}{2}$  of 1% at 5 watts eliminate the harsh unpleasant qualities which contribute to listening fatigue.

The HEATHKIT PREAMPLIFIER (available separately or in combination with the amplifier kit) features inputs for magnetic or low level cartridges, crystal pickups and tuners, turnover control for LP or 78 type records, individual bass and treble tone controls each providing up to 15 DB of boost or attenuation. Special notched shafts on preamplifier controls and switches adaptable to custom installation. The preamplifier can be mounted in any position and a liberal length of connecting cable is supplied. No radio experience is required to construct this amplifier. All punching, forming or drilling has already been done. The complete kit includes all necessary parts as well as a detailed step by step construction manual with pictorial diagrams to greatly simplify the construction.

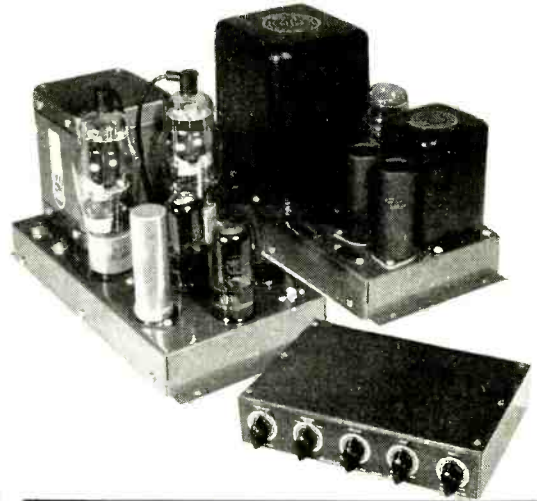

## Heathkit FM TUNER KIT

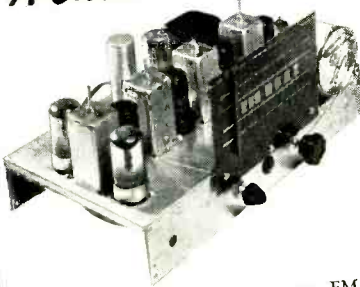

MODEL FM-2  
SHIPPING  
WT. 9 LBS.

**\$22<sup>50</sup>**

The HEATHKIT MODEL FM-2 TUNER specifically designed for simplified kit construction features a preassembled and adjusted tuning a 9 to 1 ratio vernier drive using a calibrated six inch slide rule type dial. The usual frequency coverage of 88 to 108 megacycles is provided. Experience the thrill of building your own FM tuner. Operate it through your amplifier or radio and enjoy all the advantages of true FM reception. Transformer operated power supply to simplify connections to all types of audio systems. The kit is supplied complete with all 8 tubes and necessary material required for construction. A complete instruction manual simplifies assembly and operation.

## Heathkit ECONOMY 6 WATT AMPLIFIER KIT



MODEL A-7  
SHIPPING  
WT. 10 LBS.

**\$14<sup>50</sup>**

The HEATHKIT Model A-7 amplifier features beam power, push pull output with frequency response flat  $\pm 1\frac{1}{2}$ DB from 20 to 20,000 cycles. Separate volume, bass and treble controls. Two input circuits, output impedances of 4, 8, and 15 ohms. Peak power output rated at full 6 watts. High quality components, simplified layout, attractive gray finished chassis, break off type adjustable length control shafts and attractive lettered control panel.

THE MODEL A7A amplifier incorporates a preamplifier stage with special compensated network to provide the necessary voltage gain for operation with variable reluctance or low output level phono cartridges. Excellent gain for microphone operation in a moderate powered sound system. **\$16.50**

## Heathkit HIGH FIDELITY 20 WATT AMPLIFIER KIT

The HEATHKIT MODEL A-8 amplifier kit was designed to deliver high fidelity performance with adequate power output at moderate cost. The frequency response is within  $\pm 1$  DB from 20 to 20,000 cycles. Distortion at 3 DB below maximum power output at 1000 cycles is only .8%. The amplifier features a Chicago power transformer in a drawn steel case and a Peerless output transformer with output impedances of 4, 8, and 16 ohms available. Separate bass and treble tone controls permit wide range of tonal adjustment to meet the requirements of the most discerning listener. The amplifier uses a 6SJ7 voltage amplifier, a 6SN7 amplifier and phase splitter and two 6L6's in push pull output and a 5U4G rectifier. Two input jacks for either crystal or tuner operation. The kit includes all necessary material as well as a detailed step by step construction manual.



MODEL A-8  
SHIPPING WT. 19 LBS.

**\$33<sup>50</sup>**

MODEL A8-A features an added 6SJ7 stage (preamplifier) for operating from a variable reluctance cartridge or other low output level phono pickups. Can also be used with a microphone. A 3 position panel switch affords the desired input service. **\$35.50**

### PRICES OF VARIOUS COMBINATIONS

WA-A1 Amplifier kit — Combination 1 — (Main amplifier and Power Supply) complete with WA-P1 Preamplifier kit.

Total Shipping Weight 39 lbs. (Shipped Express only) **\$69<sup>50</sup>**

WA-A1 Amplifier kit only — Combination 4 — (Main Amplifier and Power Supply). Less WA-P1 Preamplifier.

Total Shipping Weight 29 lbs. (Shipped Express only) Price . . . . **\$49.75**

WA-P1 Preamplifier kit only. (less power supply) Tubes included.

Total Shipping Weight 7 lbs. (Shipped Exp. or P.P.) Price . . . . **\$19.75**

PLEASE BE SURE TO STATE COMBINATION NUMBER WHEN ORDERING.

EXPORT AGENT  
ROCKE INTERNATIONAL CORP.  
13 E. 40TH ST.  
NEW YORK CITY (16)  
CASE, ARK. N.Y.

The **HEATH COMPANY**

. . . BENTON HARBOR 20, MICHIGAN



# Heathkit SUPERHETERODYNE RECEIVER KITS

- High gain dual iron core tuned type IF transformers
- AC transformer operation for safety
- Continuously variable tone control
- Sturdy punched and plated steel chassis
- Ideal for custom installation
- Full AVC action
- Inverse feedback for improved frequency response
- Kit supplied with all necessary construction material except speaker and cabinet. (Available separately if desired).

6 tube all wave circuit.  
3 ranges, continuous coverage 550 kc to over 20 megacycles, shipping wt. 11 lbs.

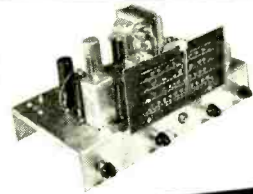

Model AR-1  
**\$23.50**

5 tube broadcast band  
550 to 1600 kc coverage,  
shipping wt. 11 lbs.

Model BR-1  
**\$19.50**

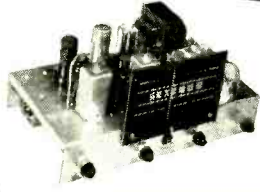

Two excellent radio receiver kits featuring clean design and open layout for simplified construction. Satisfy that urge to build your own radio receiver and select the model which meets your requirements. Both receivers feature continuously variable tone control, a radio phono switch and phono input and an AC receptacle for the phono motor. A six inch calibrated slide rule type dial with a 9 to 1 ratio vernier dial drive insures easy tuning.

## SHIPPING INFORMATION

ON PARCEL POST ORDERS include postage for weight shown and insurance. (We insure all shipments.) Don't worry about sending more than the correct amount — if you send us too much, every extra cent will be promptly returned.

ON EXPRESS ORDERS do not include transportation charges. They will be collected by Express Agency on delivery.

ORDERS FROM CANADA must include full remittance for merchandise.

Orders processed on the same day received. Customers notified of unavoidable delay.

U. S. postal or express money orders, bank drafts or checks are acceptable. Do not send loose coins or stamps.

ALL PRICES SUBJECT TO CHANGE WITHOUT NOTICE

EXPORT AGENT  
ROCKE INTERNATIONAL CORP.  
13 E. 40th ST.  
NEW YORK CITY (16)  
CABLE: ARIAB N.Y.

# The HEATH COMPANY

... BENTON HARBOR 20, MICHIGAN

## ORDER BLANK



From \_\_\_\_\_

SHIP VIA

- Parcel Post
- Express
- Freight
- Best Way

(PLEASE PRINT)

QUANTITY	ITEM	PRICE	QUANTITY	ITEM	PRICE
	Heathkit Oscilloscope Kit—Model O-8 (29 lbs.)	\$43.50		Heathkit Square Wave Gen. Kit—Model SQ-1 (14 lbs.)	\$29.50
	Heathkit Intensifier Kit (O-8 only) No. 339 (1 lb.)	7.50		Heathkit AC VTVM Kit—Model AV-2 (5 lbs.)	29.50
	Heathkit Voltage Calibrator Kit—Model VC-1 (5 lbs.)	9.50		Heathkit Intermodulation Analyzer Kit—Model IM-1 (18 lbs.)	39.50
	Heathkit Electronic Switch Kit—Model S-2 (11 lbs.)	19.50		Heathkit Regulated Power Supply Kit—Model PS-2 (20 lbs.)	29.50
	Heathkit Scope Demodulator Probe Kit No. 337 (1 lb.)	4.50		Heathkit Handitester Kit—Model M-1 (3 lbs.)	13.50
	Heathkit T.V. Alignment Generator Kit—Model TS-2 (20 lbs.)	39.50		Heathkit Decade Resistance Kit—Model DR-1 (4 lbs.)	19.50
	Heathkit Q Meter Kit—Model QM-1 (12 lbs.)	39.50		Heathkit Decade Condenser Kit—Model DC-1 (4 lbs.)	16.50
	Heathkit Grid Dip Meter Kit—Model GD-1 (4 lbs.)	19.50		Heathkit Impedance Bridge Kit—Model IB-1B (15 lbs.)	69.50
	Heathkit VTVM Kit—Model V-6 (7 lbs.)	24.50		Heathkit Battery Tester Kit—Model BT-1 (3 lbs.)	7.50
	Heathkit RF Probe Kit No. 309 (1 lb.)	5.50		Heathkit Resistance Substitution Box Kit—Model RS-1 (3 lbs.)	5.50
	Heathkit HV Probe Kit No. 336 (2 lbs.)	5.50		Heathkit F.M. Tuner Kit—Model FM-2 (9 lbs.)	22.50
	Heathkit Peak-to-Peak Volt. Probe Kit No. 338 (2 lbs.)	6.50		Heathkit Broadcast Receiver Kit—Model BR-1 (11 lbs.)	19.50
	Heathkit Visual-Aural Signal Tracer Kit—Model T-3 (8 lbs.)	22.50		Heathkit Three Band Receiver Kit—Model AR-1 (11 lbs.)	23.50
	Heathkit Condenser Checker Kit—Model C-3 (7 lbs.)	19.50		Heathkit Amplifier Kit—Model A-7 (10 lbs.)	14.50
	Heathkit RF Signal Generator Kit—Model SG-7 (7 lbs.)	19.50		Heathkit Amplifier Kit—Model A-7A (10 lbs.)	16.50
	Heathkit Tube Checker Kit—Model TC-1 (12 lbs.)	29.50		Heathkit Amplifier Kit—Model A-8 (19 lbs.)	33.50
	Heathkit T.V. Tube Adapter No. 355 (1 lb.)	4.50		Heathkit Amplifier Kit—Model A-8A (19 lbs.)	35.50
	Heathkit Battery Eliminator Kit—Model BE-3 (20 lbs.)	24.50		WA-A1 Amplifier Kit—Comb. 1 (Incl. main amplifier, power supply and WA-P1 preamplifier) (39 lbs.) Shipped express only	69.50
	Heathkit Vibrator Tester Kit—Model VT-1 (7 lbs.)	14.50		WA-A1 Amplifier Kit—Comb. 4 (Main amp. and power supply) (29 lbs.) Shipped express only.	49.75
	Heathkit Audio Generator Kit—Model AG-8 (16 lbs.)	29.50		WA-P1 Preamplifier Kit (7 lbs.) (Shipped exp. or p.p.)	19.75
	Heathkit Audio Oscillator Kit—Model AO-1 (14 lbs.)	24.50			
	Heathkit Audio Frequency Meter Kit—Model AF-1 (15 lbs.)	34.50			

\*Please ship C.O.D.  Postage enclosed for \_\_\_\_\_ lbs.

Enclosed find  Check  Money Order for \_\_\_\_\_



# PETER AND THE PILOT LIGHT

By HARRY A. NICKERSON

**T**HAT'S a wreck of a heck of a set," said Peter.

Peter, is my right-hand man (or rather boy). He dusts off the chassis, makes repairs strictly as directed, handles the screwdriver and soldering iron almost as well as a girl set-assembler in a factory. He's also a pump, that pulls up my radio wisdom or lack of it and sometimes stores it in his small reservoir of a brain.

"Look at the dial—there's not even a pilot light," he continued. "How would you take care of that?"

Sure enough, there was no pilot-light socket or bulb. The set was an old a.c.-d.c. using .3-amp tubes; the line cord had been completely removed.

"Well," I said, somewhat cautiously, "you take down that radio catalog and look up pilot lamps." He did, and this is the rather lengthy list:

Screw-base tubular		
No.	Volts	Amperes
41	2.5	0.50
42	3.2	0.35
40	6.3	0.15
46	6.3	0.25
48	2.	0.06
292	2.9	0.17
Bayonet-base tubular		
43	2.5	0.50
44	6.3	0.25
45	3.2	0.35
49	2.	0.06
47	6.3	0.15
291	2.9	—
1490	3.2	0.16
Screw-base round		
50	6.8	0.20
Bayonet-base round		
51	6.8	1 c.p.
55	6.8	2 c.p.

"Now," said I, "In practice you seldom see any except 0.15 and possibly 0.25-ampere bayonet-base pilots that operate around 6 volts, but in the older sets there were mostly screw bases, and in one old set, a 4-tube a.c.-d.c. I repaired once, there was a plain 0.50-ampere pilot in series with the string of 0.3-amp. tubes."

"What is that No. 51 and 55 c.p.—certified public stuff?" queried Peter. I explained that years ago electric lamps were usually classified according to candle power.

Being in a generous mood, I explained further that the filament inside the glass bulb was supported near its base by a bit of colored glass called a *bead*. "You can usually depend on a

brown bead to mean a 0.15-amp and a blue bead to mean a 0.25-amp filament, while a white bead very likely is a 0.50-amp type, although if you are replacing a pilot light, it is better to put in one of the same number as marked on the brass base, rather than depend on the bead."

Peter was not interested. "Let's get back to the set! I can see you putting in a 6-8-volt bulb on a 6-volt a.c. set where all the tubes are in parallel; you just put the pilot in shunt with the tube filaments; but how do you work this resistance line cord and pilot light business with a.c.-d.c.?"

"Well, Peter, I think I've explained how to calculate a line cord's resistance for you eleven times, but here goes again. You add up the total voltages of the tubes in series, subtract it from 117 (the line voltage) and divide what you have left by the amperage flowing through the string of tubes in series to find the resistance. Now if you want to put in a pilot, you put it in series with the tube filaments too, but to do it right you find the resistance of the pilot as shunted by a proper resistor and make the line resistance cord that much less ohms value. Suppose you have two 25-volt and two 6-volt tubes; they add up to 62 volts. Subtract 62 from 117 and you get 55 volts. That is the voltage drop. If you have 0.3-amp tubes, you divide the 55 by 0.3 and get about 180 ohms for your line cord. If you have a 6.8-volt, 0.15-amp pilot shunted by a 25-ohm resistor, as frequently is the case, their combined resistance in ohms will be found by figuring the resistance of the pilot as 6.8 divided by 0.15, or about 45 ohms; then since the resistance of two resistors in parallel is equal to their product divided by their sum,

$$\frac{45 \times 25}{45 + 25} = 16 \text{ ohms}$$

So you really ought to use a resistance line cord of 180 ohms less 16, or about 165 ohms value, with the pilot bulb and its shunt resistor also in the circuit."

"But," protested Pete, "if you say that the resistance of the pilot lamp is 45 ohms, and it burns 0.15 amp, why don't you just put a 45-ohm resistor across it? Then the lamp will get half the 0.3 amp current, and will light up O.K. without all the figuring. Why do they want to use a 25-ohm resistor?"

"There's a good reason," I told him. "Actually, if you did it your way, it would work out all right, at least for a while. But the pilot would be burning at full brightness, and would flare up every time you turned the set on. So they make the resistor take a little more than half the current. Then when the set is turned on, the light does not

go up much higher than its rated voltage, and when the filaments warm up, it settles down to about 5 volts. That's bright enough, and the light lasts longer.

Besides, if it does burn out, the voltage across the 25-ohm resistor only goes up a volt or two, and the set works just as well as with the light in circuit. With 0.3-amp tubes, use about a 2-watt resistor in shunt with the pilot."

"I just noticed this old hunk o' junk doesn't have any glass dial or place for a pilot light to shine through," observed Peter.

"There are two ways at least you can fix that," I told him. "Hang a dial light from the top of the speaker, running two insulated wires through one of the holes on the edge of the cone frame, and let the light hang in the middle of the speaker cone. It will shine through the grille cloth and at least show that the set is turned on. Or drill a hole through the metal dial, put in a rubber grommet just big enough to let through a pilot light socket at the back of the dial, then push in a bayonet type No. 51 small round dialite, which will project a bit at the front of the dial."

"These jobs with the pilot hooked in with a ballast tube puzzle me. What do the numbers on ballast tubes mean?" asked Peter the inquisitive.

"They aren't uniform," I answered. "A lot of them are marked to kill three birds with one stone, but we have some General Electric ballasts that we have to look in the catalog to tell what they are. The three-bird kind might be marked K55B or BK55B. The K or BK means that a 0.15-amp filament lamp is to be used with the particular ballast tube; the 55 means the voltage drop (for a 0.3-amp tube string the hot resistance of the ballast would be around 180 ohms); and the B stands for the wiring of the resistances inside the tube; so you know what prongs of the ballast are to be connected to the tubes and which to the pilot. Most of the octal-base ballasts have the pilot connected across pins 7 and 8, and the resistance of the ballast in series with the tubes (besides that across 7 and 8) would be the resistance from pin 3 of the ballast to pin 8. The letter B stands for a single pilot, other letters stand for one or more pilots and their method of connection across pins of the ballast. I generally look it up in an old "My Technical Manual" which has a lot of good stuff in it that I never get around to memorizing. An L55B would be intended for use with a 0.25-amp; M55B probably with a 0.20-amp pilot. Sometimes a fourth wire in a line resistance cord provides a shunt for a pilot, but somehow or other I don't use that. Besides the low-voltage pilot lights, of



*More POWER to you...  
with the Radiart TV Booster*



- ★ High signal-to-noise ratio for less "snowy" pictures.
- ★ Wide band amplification for sharp pictures free from "smear".
- ★ Complete neutralization for stable operations.
- ★ Large, handsome dial face for easy reading.
- ★ Operates on 115 V. A. C., 60 cycle current.
- ★ Attractively styled cabinet with mahogany grained polished finish . . . matching the rotor control cabinet . . . together making the TV TWINS . . . the ideal combination for the MOST in TV reception.

Here's the power boost needed to get the MOST from any TV set! It improves the picture because it increases contrast . . . minimizes ghosts, snow and interference and actually STRENGTHENS the signal! Easily installed — simple in operation — a welcome addition to any home.

*The Perfect Partner to the CDR Rotor...they go together*



**THE RADIART CORPORATION** CLEVELAND 13, OHIO

VIBRATORS • AUTO AERIALS • TV ANTENNAS • ROTATORS • POWER SUPPLIES







## ***New* CBS-HYTRON**

# Germanium Diodes

## Guaranteed Moisture-Proof!

### GENERAL PURPOSE TYPES

1N48

1N51

1N52

1N63

1N64

1N65

1N69\*

1N70\*

1N75

1N81\*

\*JAN TYPES

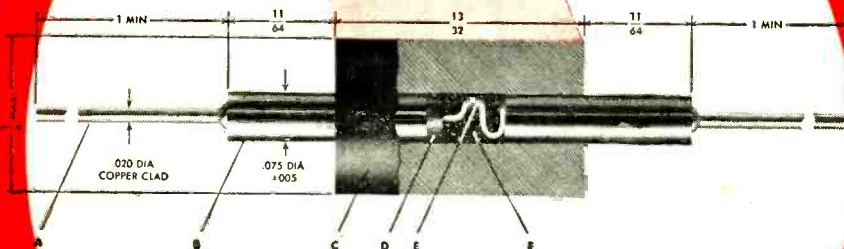

### Mechanical Specifications

- A. .020" copper-clad wire
- B. Nickel-silver "clip-in" pin
- C. Glass-filled plastic case
- D. Germanium crystal soldered directly to base
- E. .005" tungsten cat whisker
- F. Moisture-resistant impregnating wax

### WHY CBS-HYTRON GERMANIUM DIODES ARE BETTER RECTIFIERS

1. **MOISTURE-PROOF** . . . eliminates humidity and contamination problems
2. **SELF-HEALING** . . . self-recuperating from temporary overloads
3. **SUBMINIATURIZED** . . . only 1/2 inch long, 1/4 inch in diameter
4. **SOLDERED WAFER** . . . omission of plating eliminates flaking
5. **LOW SHUNT CAPACITY** . . . 0.8  $\mu\text{mfd}$  average
6. **SELF-INSULATING CASE** . . . mounts as easily as a resistor
7. **EXCEPTIONAL LIFE** . . . 10,000 hours minimum under rated conditions
8. **NO FILAMENTS** . . . low drain, no hum

Vital germanium wafer in a CBS-Hytron diode is *guaranteed moisture-proof*. Sealed against deadly moisture . . . fumes . . . and contamination, a CBS-Hytron diode keeps moisture where it belongs . . . out! First, by a chemically and electrically inert impregnating wax. Second, by a glass-filled phenolic case. With *moisture-proof* CBS-Hytron germanium diodes, you can be sure of maximum trouble-free life.

Superior techniques also permit CBS-Hytron to omit plating of the germanium wafer. Soldering is directly to the base. Thus flaking is eliminated and quality improved. Universal design of CBS-Hytron diodes follows Joint Army-Navy specifications. "Clip-in" feature gives you versatility, ruggedness, and electrical stability. Flexible pigtailed of copper-clad steel welded into sturdy nickel pins also insure you against damage by soldering heat.

Check the eight important-to-you reasons why CBS-Hytron *moisture-proof* germanium diodes are better rectifiers. Send today for complete data and interchangeability sheets. Specify CBS-Hytron *guaranteed moisture-proof* diodes for superior, trouble-free operation.



SALEM, MASSACHUSETTS

# AUDIO V.T. VOLTMETER

... for sensitive measurements

By RUFUS P. TURNER

**W**HAT is the signal voltage at the preamplifier grid? How much combined hum and noise is there at the output of an amplifier? Exactly how effective is a tuned filter? Is a bridge actually balanced to a perfect null? What is the output voltage of my microphone? How sensitive is my oscilloscope?

Questions like these are always coming up in the minds of audio experimenters. Such small voltages cannot be read accurately (if they can be seen at all) on the most sensitive a.c. range of a service type v.t.v.m.

Much serious audio experimentation and performance testing has been hampered by lack of an a.c. millivoltmeter. The professional audio engineer has access to ultra-sensitive instruments such as the Ballantine, Hewlett-Packard, Daven, and others. But these are priced way out of reach of most technicians and hobbyists. Some experimenters have built their own a.c. millivoltmeters; others have tried wide-band amplifiers ahead of ordinary v.t.v.m.'s, but results have not been eminently successful.

Now a sensitive, accurate instrument is available as an inexpensive kit. The Heathkit model AV-2 (shown above), permits measurements from 0.2 millivolt to 300 volts r.m.s. in 10 ranges: 0-10, 0-30, 0-100, and 0-300 millivolts; 0-1, 0-3, 0-10, 0-30, 0-100, and 0-300 volts. Ten decibel ranges (based on 1 milliwatt 600 ohms) cover the total spread from -52 to +52 dbm. This new instrument is a.c. operated, has only one selector control (the range switch), and requires no zero adjustment. Input impedance is 1 megohm at 1,000 cycles, and frequency response is plus or minus 1 db from 10 cycles to 50 kilocycles. Power consumption is only 10 watts. No elaborate equipment or methods are required for calibration—just one setting of the internal calibration control. The broad range of readings and extreme simplicity of this new audio meter recommend it for easy construction and for wide use in audio design, testing, and servicing.

Fig. 1 is the complete circuit of the instrument. The first stage is a 6AU6 high-gain pentode voltage amplifier. The second stage is a 6AT6 current am-

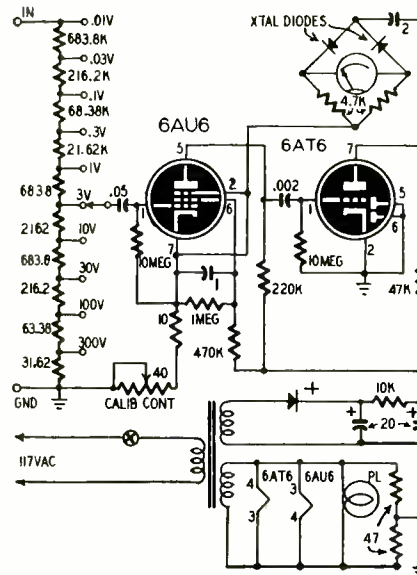
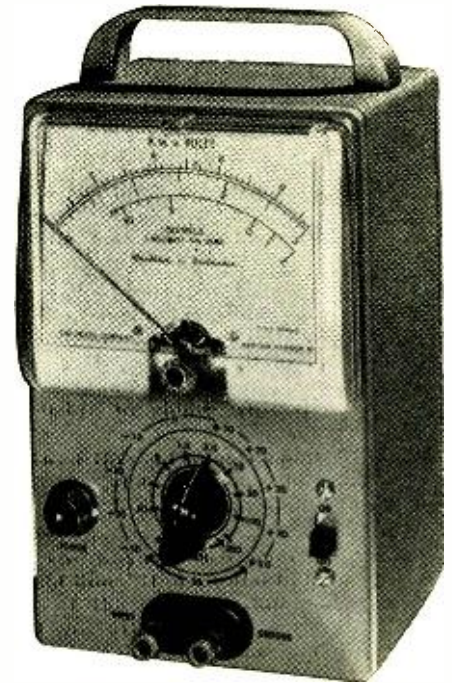

Fig. 1—Schematic of the AV-2 v.t.v.m.

plifier. Following the current amplifier is a full-wave modified-bridge rectifier (two 1N34 germanium diodes with two 4,700-ohm resistors) which drives a 0-200 d.c. microammeter. The meter bridge circuit is also part of a feedback loop returning to the input-amplifier cathode. Feedback stabilizes operation of the circuit, making it substantially independent of variations in tube characteristics and supply voltages. It also improves the frequency response and linearizes the meter scale. With feedback in the circuit, response is proportional to the average value of the applied signal voltage, a desirable feature in an audio v.t.v.m.

Operating voltages are furnished by a miniature a.c. power supply. For compactness and cool operation, a selenium rectifier is used. A resistance-capacitance filter smooths out the d.c.

The single calibration control is a 40-ohm potentiometer in the 6AU6 cathode



circuit. This control is mounted inside the case, since it requires adjustment only when the instrument is first calibrated or when replacing tubes. The instrument is only 7 $\frac{3}{16}$  inches high, 4 $\frac{11}{16}$  inches wide, and 4 $\frac{1}{8}$  inches deep, and weighs slightly over 3 pounds. The 4-inch rectangular meter has wide scale divisions for high readability.

Although the components are mounted close together, there is no trouble from stray coupling and feedback if ordinary care is used in mounting and wiring. A box behind the meter shields it from the under-chassis components and wiring.

Calibration is very simple. Apply an accurately known a.c. voltage to the input terminals after the instrument has had a 5- to 10-minute warmup. This voltage should be as near as possible to the top of one of the ranges. Adjust the calibration control to bring the meter pointer exactly to the proper reading on the scale. This automatically calibrates the instrument on all ranges, since precision resistors are employed in range switching. The frequency of the calibrating voltage is not important, although most experimenters will probably find it convenient to use the power-line frequency. A small transformer with any secondary rating up to about 250 volts, and an accurate a.c. voltmeter are all you need. The power line may be used directly for calibrating the meter on its 300-volt range.

There is no substitute for an audio millivoltmeter of this type on the technician's bench. Amplifiers, loudspeakers, transformers, chokes, filters, microphones, pickups, and a host of other audio components and systems may be checked for performance at conventional low signal levels. Resistors and capacitors may be checked for noise in operating circuits.

END



**SUCCESSFUL SERVICING . . .**

by John F. Rider

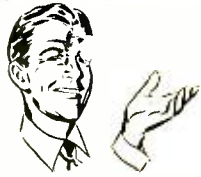

**YES, RIDER SERVICING DATA DOES MAKE TV SERVICING EASY!**

Read what these satisfied Rider users say. These are men like yourself: professional service technicians who are faced with the same servicing problems as you. They found, just as you will, that tv servicing can be easy. Here's what they say:

"... 3 weeks ago I had a receiver in my shop for which there seemed to be no repair possible. According to the one schematic I had for this receiver, it should have operated perfectly. I was on the verge of returning the receiver to the customer and admitting defeat, when a technician friend suggested I check the receiver with Rider servicing data. I did; with the result that I found the trouble to be a production change which was not explained in the data I had been using. Needless to say, I'm a Rider user from now on!" John Ottenheimer, Radio Television Clinic, 137 Main St., Hempstead, L. I., N. Y.

"... and as a result of using your data, I haven't had a single callback in 9 months!" J. W. Scatard & Co., 7135 Germantown Avenue, Philadelphia 19, Pennsylvania.

**WHAT'S THE SECRET?**

It's simple! The one thing that Rider gives you is *all the facts*. That's the one big difference between Rider Servicing Data and any other kind. Rider Servicing Data is official, complete, factory-authorized data. Exactly as issued by the manufacturer who made the set . . . with all of his changes and modifications . . . organized into indexed, easy-to-follow style. This means that when you repair a set with Rider Servicing Data, you have everything in front of you. Everything that you must know in order to do a fast, accurate diagnosis and make a prestige-building, permanent repair!

In Rider Servicing Data you get all of the manufacturer's troubleshooting test patterns . . . schematics of all his productions . . . stage by stage alignment curves . . . clear, enlarged chassis views . . . the manufacturer's circuit changes . . . circuit explanations . . . voltage data, disassembly information and much, much more. For example: Rider Servicing Data has shown scope waveforms in TV receivers ever since the first TV receiver was made!

And Rider Servicing Data now has these important new features: manufacturers' trouble cures and guaranteed replacement parts listings. The manufacturers' trouble cures are standard (3 x 5") index cards, called Rider Handies, containing vital manufacturer-issued permanent trouble cures plus production changes. Each Handy is identified with a manufacturer and receiver model. With Rider Handies you save countless hours of diagnosis and repair time . . . because Handies contain the data you must have to make permanent repairs on many receivers.

The replacement parts listings are included in the latest Rider Servicing Data. All these replacement parts must meet the physical and electrical performance ratings of the original equipment.

**RIDER TV SERVICING DATA COMES IN TWO FORMS.**

**MANUALS ■**

The TV Manual form has nine volumes covering more than 4,200 models of television receivers. Each volume has over 2,000 (8½ x 11") pages of servicing data with an index covering the contents of all volumes. Each volume is attractively bound in a permanent hard cover. The Manual form is ideal for shop use and as a permanent reference.



**TEK-FILE ■**

The Tek-File form now covers more than 2,200 models. Each Tek-File pack contains complete data for several of the most popular models . . . the ones you are called to work on every day. (Contents are clearly marked on the cover of each pack.) These models are bound in handy, standard file folders for easy home and shop use. In each Tek-File pack you get a special coupon. 15 of these coupons plus a small handling charge entitles you to a permanent, hard-cover manual binder for Tek-File shelf use. Or if you prefer, each coupon is worth five cents toward the purchase of any Rider book. **Not!** Get your free Tek-File indexes covering the contents of all packs at your jobber's. If he doesn't have them, write us.

For the complete servicing facts on radio get Rider Radio Manuals. In 22 volumes Rider Radio Manuals give you the complete, factory-authorized, official AM, FM radio servicing data for receivers manufactured over the past 22 years! Plus complete data on auto radios, record changers, tuners and recorders. Everything is organized and indexed to make radio servicing easy.

**DON'T BE SWITCHED**

Remember, Rider Manuals and Tek-Files are the *only* source for complete published servicing data. If your jobber doesn't have them, **DON'T BE SWITCHED!** If he doesn't have Rider Manuals, write to us . . . we'll tell you where to get them. If he doesn't have Rider Tek-Files, write to us . . . we'll fill your order directly. (Please include your jobber's name.) *Why not prove to yourself that Rider Servicing Data really makes servicing easy? Try one Rider TV Tek-File pack at our risk! Try a pack for the next receiver you repair . . . if you don't agree that it makes your servicing easier than anything you've ever used RETURN THE PACK TO US WITHIN SEVEN DAYS AND WE'LL SEND YOU A FULL REFUND! So act now . . . you have absolutely nothing to lose!*

**RIDER "HOW-TO-DO-IT" BOOKSHELF.**

**1. TV Troubleshooting and Repair Guide Book.**

Save time! Loaded with troubleshooting charts and waveform pictures. 10 vital chapters. 204, 8½ x 11" pages. Paper cover \$3.90

**2. Ency on CR 'Scopes and Uses.**

Most complete work on 'scopes! What they are, what they do, construction and capabilities. 992 pages 8½ x 11". 3000 ill. Cloth cover \$9.00

**3. Vacuum Tube Voltmeters.**

All the facts! Design, construction, testing, maintenance, applications, etc., of all types of VTVM's. 432 pages 5½ x 8½". 210 ill. Cloth cover \$4.50

**4. TV and Other Receiving Antennas**

No mathematics! Easy to read facts. Complete data on 50 basic antenna types. 606 pages 5½ x 8½". 310 ill. Cloth cover \$6.60

**IT'S NEWS! TELL-A-FAULT**

It's Rider's new monthly tv troubleshooting service. Save countless hours of diagnosis time. Rider experts do your trouble-shooting for you . . . in pictures, charts, and symptom and cure sheets. Monthly bulletins. Send coupon for complete story — no obligation.



**JOHN F. RIDER, Publisher, Inc.**  
**480 Canal Street, New York 13, N. Y.**

Please send me book(s) circled. I understand, if not satisfied, I may return them within 10 days for full refund.

Send Free Data on Tell-A-Fault.

NAME \_\_\_\_\_  
 ADDRESS \_\_\_\_\_  
 CITY \_\_\_\_\_  
 ZONE \_\_\_\_\_ STATE \_\_\_\_\_ RE-10  
 (Please Print).

# TRANSMISSION LINES SIMPLIFIED

Like one-way streets, they're fine if they take you where you're going—but watch out if you have to turn around!

By HECTOR E. FRENCH

IT'S usually easy enough to take electrical energy from one place to another—all that's needed at low frequencies is some wire for a conductor, and Ohm's law to figure out what is going to happen. But at high frequencies, Ohm's law seems to be a failure. The voltages and currents do all sorts of queer things along the line, and we don't find it easy to visualize what's really happening.

But it's really not too difficult. Watch.

First, imagine a transmission line that reaches out to infinity,



and apply a signal to the line.

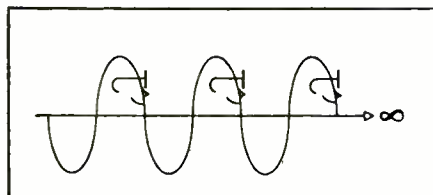

The ratio of the voltage to the current is the *characteristic impedance* of the line,

CHARACTERISTIC IMPEDANCE  
IS  
VOLTAGE ÷ CURRENT

and if the line has no losses, both the voltage and the current can keep going forever

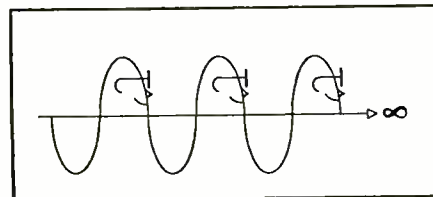

without dying out. And no matter how far or how long the signal travels, it will continue to see ahead of it the same identical value of characteristic impedance. Which is a monotonous situation indeed.

So to break up the monotony, imagine

that you're located somewhere out in space along the line a couple of million miles ahead of the oncoming signal



and cut the line.



Now connect a resistance between the cut end of the line and ground, with the value of the resistance exactly equal to the characteristic impedance of the transmission line.

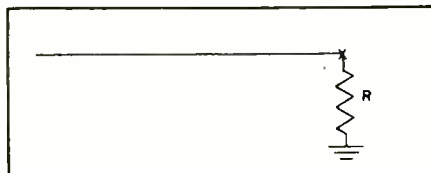

(Don't ask where the ground comes from—it's like learning to play chess.)

Not too many seconds later, the signal will come whooping up the line at just a little less than the speed of light, and will run up against the resistance.

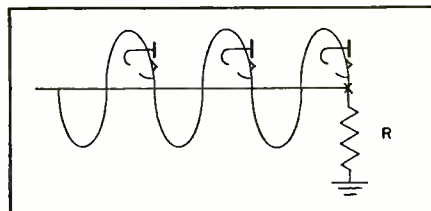

To the approaching signal, the resistance will appear to be just a continuation of the line, because the terminating resistance has exactly the same value as the characteristic impedance of the line. So all the signal energy flows down back into the ground through the resistance and is dissipated as heat.

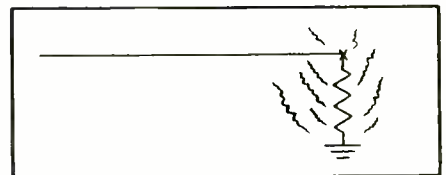

And that's all there is to that side of the picture.



This is what is called a *properly terminated transmission line*. All the energy pumped into one end of the line goes directly through the load at the other end, assuming no losses in the line. The only requirement is that the load impedance be the same as the line's characteristic impedance. A good example is a transmitting antenna whose feeders are correctly matched to the radiating element, or a receiving antenna whose feeders are correctly matched to the receiver.

But this isn't the only possible way to terminate the line. What if the line were cut and no resistance load put on at all?

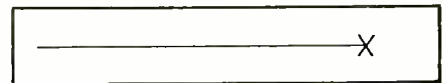

Then when the signal gets to the unloaded end of the line it can't go any farther.

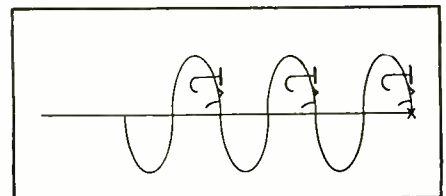

The only conductor available is the one that brought the signal away out here to the end of the line—so the transmitted signal does the only thing it can do. It promptly turns around and goes back along the same line, like a



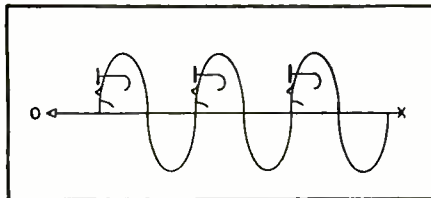

reflection—back toward the beginning of the line.

The trouble is, this reflected signal is on the same line at the same time as the transmitted signal. And the combination

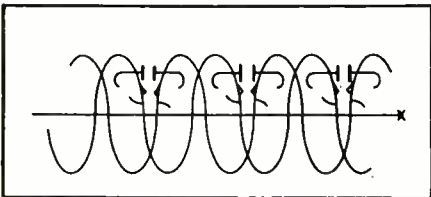

starts to look like a very confusing situation.

But it's not as complicated as it looks. To see how easily the system can be analyzed, watch what happens to the voltage at the end of the line. This end is completely open. Nothing there at all to hold down the voltage. So, at the end of an open-circuited transmission line, the voltage is a maximum. This shouldn't be so very difficult to remember. Why shouldn't the voltage at the end of an open line be at a maximum—what is there to stop it?

To analyze another point on the same line, simply back up from the end of the line by a quarter wave

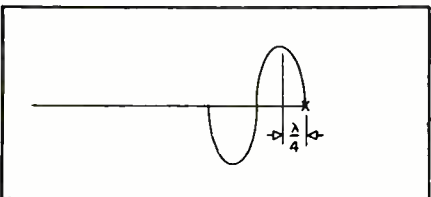

and watch what happens to the voltage at this point as the transmitted signal goes by.

Just like any other a.c., the voltage at this point will go negative,

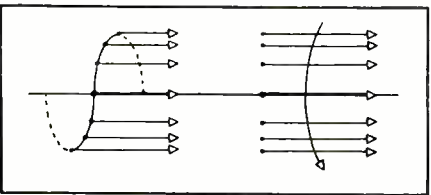

and positive,

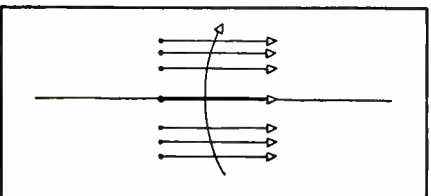

and keep on repeating the cycle as long as there is any transmitted signal.

Now watch what is happening to the reflected voltage at the same point. This reflected voltage will be going through

the same cycle as the transmitted voltage, obviously enough. But the reflected voltage is going positive

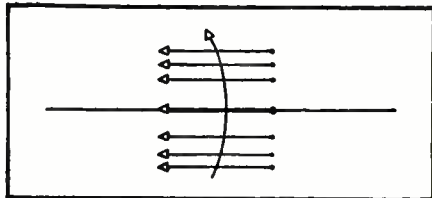

when the transmitted voltage is going negative, and the reflected voltage is going negative

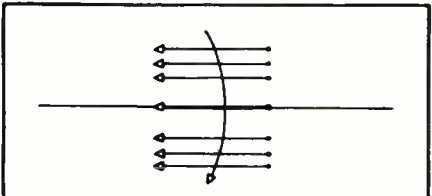

when the transmitted voltage is going positive!

So whether the combined voltages at the quarter-wave point are considered like this:

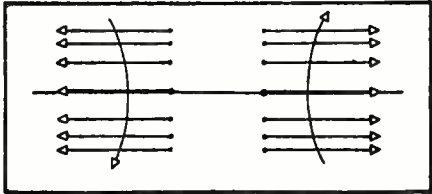

or this:

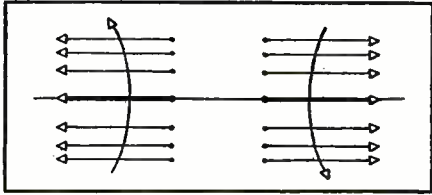

the two voltages will always be in opposition and will balance out to zero. Therefore, at a point a quarter wave back from the end of an open-circuited transmission line the voltage is always zero.

This surely differs from a conventional a.c. circuit—here is a point along a hot line where there is zero voltage!

Now back up from the end of the line by another quarter wave,

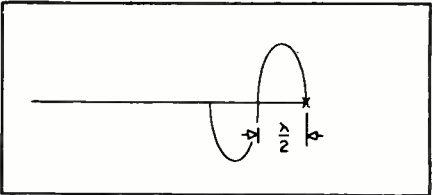

(making it a half wave from the end), and watch what happens to the voltage at this point. The reflected voltage this time is going positive

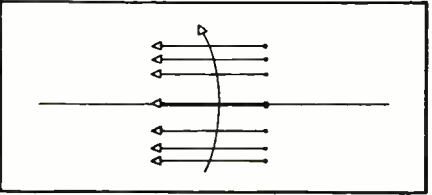

when the transmitted voltage is going positive, and the reflected voltage is going negative

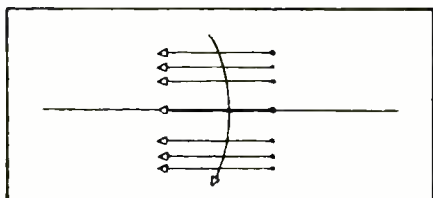

when the transmitted voltage is going negative.

So whether we look at the combination like this

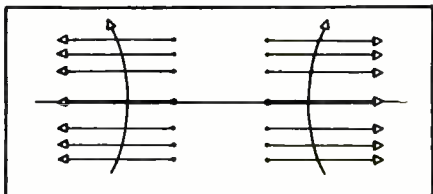

or this

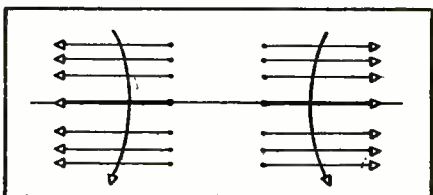

the two signals will always be aiding each other. Therefore, a half wave back from the end of an open circuited transmission line the voltage is a maximum. Just the same as it was at the very end of the line.

If these measurements are repeated at quarter-wave intervals along the line, the same sequence repeats, giving points of maximum voltage along the line with points of zero voltage between them. This is known as a system of standing waves, and it is possible to make a general statement for the whole system: with an open-circuited transmission line, at all even-numbered quarter waves from the end the voltage is a maximum, at all odd-numbered quarter waves the voltage is zero. Plus, of course, the very end of the line, where the voltage is a maximum also.

Now there's still one more thing that can be done with this transmission line. Instead of leaving the cut end open, it can be short-circuited to ground.



Don't ask where I got the ground this time, either—it's still like learning to play chess.

There's no problem at all this time with figuring out the voltage at the end of the line. There's a dead short to ground, so, at the end of a short-circuited transmission line the voltage is zero.

Now back up from the end of this short-circuited transmission line by a quarter wave, just as was done before. At this point, both a transmitted voltage and a reflected voltage will be

# Fill your parts requirements from a single dependable source

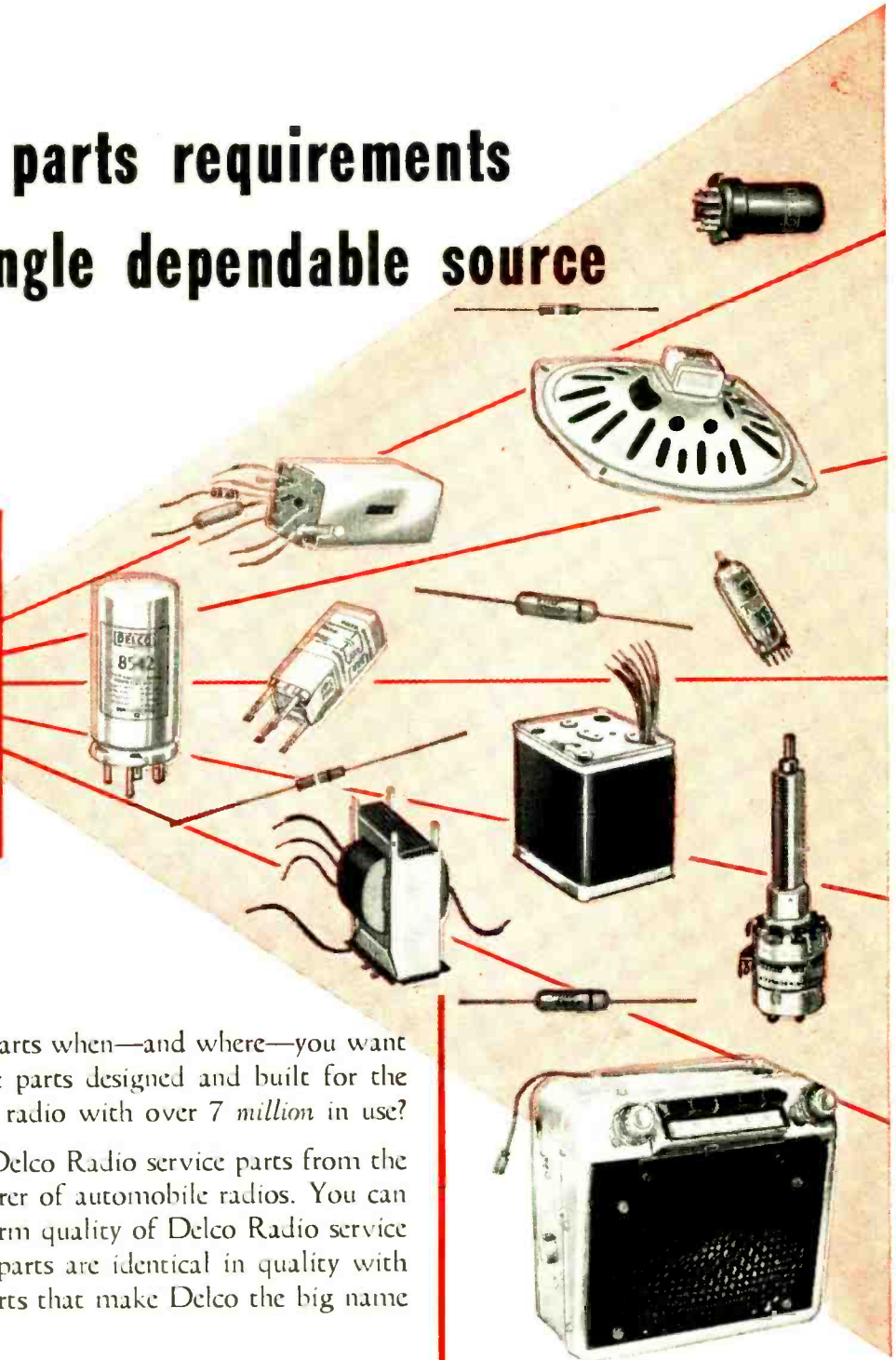

Want *good* radio service parts when—and where—you want them? Want radio service parts designed and built for the world's most popular car radio with over 7 million in use?

If you do . . . you want Delco Radio service parts from the world's largest manufacturer of automobile radios. You can depend on the high, uniform quality of Delco Radio service parts. These replacement parts are identical in quality with the original equipment parts that make Delco the big name in car radios.

Both Delco Radio original equipment and universal service parts are available promptly through United Motors wholesalers.

## DELCO RADIO PARTS

A GENERAL MOTORS PRODUCT   A UNITED MOTORS LINE

**DISTRIBUTED BY WHOLESALERS EVERYWHERE**

## DELCO RADIO

DIVISION OF GENERAL MOTORS CORPORATION  
KOKOMO, INDIANA

### THINGS TO REMEMBER ABOUT DELCO RADIO SERVICE PARTS

- 1 Offer largest market for original-equipment replacement parts.
- 2 Backed by world's largest factory devoted exclusively to automobile radios.
- 3 Designed by one of the largest and most forward-looking engineering groups devoted exclusively to automotive radio.



# BUY TEST EQUIPMENT ON THIS RADICALLY NEW TIME PAYMENT PLAN

**NO INTEREST!! - NO CARRYING CHARGES!!**

USE CONVENIENT TIME PAYMENT ORDER BLANK BELOW

Superior's New

## JUNIOR SUPER-METER

**MOST COMPLETE AND COMPACT MULTI-SERVICE INSTRUMENT EVER DESIGNED**

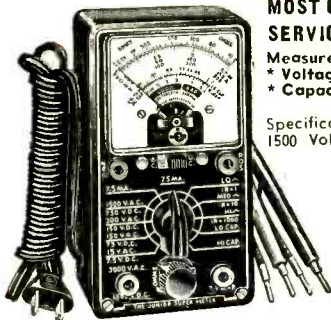

Handsome round cornered milled bakelite case 3 1/2" x 5 1/4" x 2 1/4" complete with all test leads and instructions

**\$21.40**  
NET

Measures:  
\* Voltage  
\* Capacity

\* Current  
\* Reactance  
\* Decibels

\* Resistance  
\* Inductance

Specifications: D.C. Volts: 0-7.5/75/150/750/1500 Volts. A.C. Volts: 0-15/150/300/1500/3000 Volts. Resistance: 0-10,000/100,000 ohms. 0-10 Megohms. D.C. Current: 0-7.5/75 Ma. 0-7.5 amps. Capacity: .001 Mfd.—2 Mfd., .1 Mfd.—20 Mfd. Electrolytic Leakage: Reads quality of electrolytics at 150 Volt test potential. Decibels: -10 Db to +18 Db. +10 Db to +38 Db. +38 Db. to +58 Db. Reactance: 15 ohms—25 K ohms. 15 K ohms—25 Megohms. Inductance: 5 Henry—50 Henries. 30 Henries—10 K Henries. Plus Good-Bad scale for checking the quality of electrolytic condensers.

Superior's New  
Model TV-11

## TUBE TESTER



Operates on 105-130 Volt 60 Cycles A.C. Hand-rubbed oak cabinet complete with portable cover

**\$47.50**  
NET

• Uses the new self-cleaning Lever Action Switches for individual element testing. Because all elements are numbered according to pin number in the RMA base numbering system, the user can instantly identify which element is under test. Tubes having tapped filaments and tubes with filaments terminating in more than one pin are truly tested with the Model TV-11 as any of the pins may be placed in the neutral position when necessary. • Uses no combination type sockets. Instead individual sockets are used for each type of tube. Thus it is impossible to damage a tube by inserting it in the wrong socket. • Free-moving built-in roll chart provides complete data for all tubes. • Phono jack on front panel for plugging in either phones or external amplifier detects microphonic tubes or noise due to faulty elements and loose external connections.

Superior's New  
Model 670-A

## SUPER-METER

**A combination volt-ohm milliammeter plus capacity reactance inductance and decibel measurements**



Comes housed in rugged, crackle-finished steel cabinet complete with test leads and operating instructions. Size 6 1/4" x 9 1/2" x 4 1/2".

**\$28.40**  
NET

**SPECIFICATIONS:**

D.C. VOLTS: 0 to 7.5/15/75/150/750/1,500/7,500 Volts  
A.C. VOLTS: 0 to 15/30/150/300/1,500/3,000 Volts  
OUTPUT VOLTS: 0 to 15/30/150/300/1,500/3,000 Volts  
D.C. CURRENT: 0 to 1.5/15/150 Ma. 0 to 1.5/15 Amperes  
RESISTANCE: 0 to 1,000/100,000 Ohms 0 to 10 Megohms  
CAPACITY: .001 to 1 Mfd. 1 to 50 Mfd. (Quality test for electrolytics)  
REACTANCE: 50 to 2,500 Ohms 2,500 Ohms to 2.5 Megohms  
INDUCTANCE: .15 to 7 Henries 7 to 7,000 Henries  
DECIBELS: -6 to +18 +14 to +38 +34 to +58

**ADDED FEATURE**

The Model 670-A includes a special GOOD-BAD scale for checking the quality of electrolytic condensers at a test potential of 150 Volts.

Superior's New

## TV BAR GENERATOR

**THROWS AN ACTUAL BAR PATTERN ON ANY TV RECEIVER SCREEN!**



Power Supply: 105-125 Volt 60 Cycles. Power Consumption: 20 Watts. Channels: 2-5 on panel, 7-13 by harmonics. Horizontal lines: 4 to 12 (Variable). Vertical lines: 12 (Fixed). Vertical sweep output: 60 Cycles. Horizontal sweep output: 15,750 Cycles.

Two Simple Steps

1. Connect Bar Generator to Antenna Post of any TV Receiver.
2. Plug Line Cord into A. C. Outlet and Throw Switch.

RESULT: A stable never-shifting vertical or horizontal pattern projected on the screen of the TV receiver under test.

TV Bar Generator comes complete with shielded leads and detailed operating instructions. Only **\$39.95** NET

New Model 200-AM and FM

## SIGNAL GENERATOR

**Provides complete coverage for A.M.-F.M. and TV alignment**

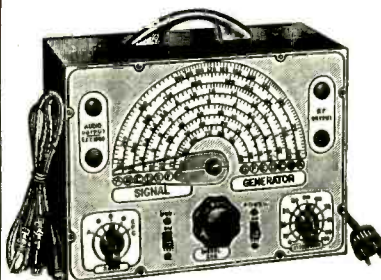

\* Tubes used: One 954 as oscillator; one 954 as modulated buffer amplifier; T-2 as modulator; 7193 as rectifier.

The Model 200 comes complete with output cable and operating instructions

**\$21.85**  
NET

### NEW TIME PAYMENT PLAN ORDER BLANK

MOSS ELECTRONIC DISTRIBUTING CO., INC.  
Dept. B-34, 38 Murray Street, New York 7, N. Y.

Please send me the units checked below. I am enclosing the down payment with order and agree to pay the monthly balance as shown. It is understood there will be no carrying, interest or any other charges, provided I send my monthly payments when due. It is further understood that should I fail to make payment when due, the full unpaid balance shall become immediately due and payable.

- JUNIOR SUPER METER ..... Total Price \$21.40  
\$5.40 down payment. Balance \$4.00 monthly for 4 months.
- MODEL TV-11 ..... Total Price \$47.50  
\$11.50 down payment. Balance \$6.00 monthly for 6 months.
- MODEL 670-A ..... Total Price \$28.40  
\$7.40 down payment. Balance \$3.50 monthly for 6 months.
- TELEVISION BAR GENERATOR ..... Total Price \$39.95  
\$9.95 down payment. Balance \$5.00 monthly for 6 months.
- MODEL 200 ..... Total Price \$21.85  
\$5.85 down payment. Balance \$4.00 monthly for 4 months.

I enclose \$\_\_\_\_\_ as down payment.  
 Ship C.O.D. for the down payment.

Signature \_\_\_\_\_

Name \_\_\_\_\_

Address \_\_\_\_\_

City \_\_\_\_\_ Zone \_\_\_\_\_ State \_\_\_\_\_

Terrific Money-Makers for Servicemen-

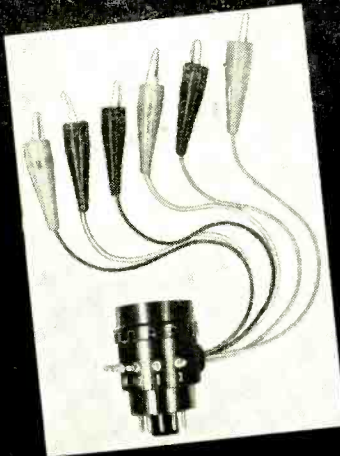

**EBCO**  
**DYNAMIC ANALYZER**  
for CR Tubes

Converts your VTVM into the finest CR Tube TESTER that money can buy.

It's the ONLY instrument that performs all the necessary dynamic tests . . . Easily attached to your Vacuum Tube Voltmeter, it enables you to make the following dynamic tests: (1) Check all socket voltages of a TV Set under actual operating conditions . . . (2) Check emission of the tube, and get related emission reading . . . (3) Check Picture Tube for open elements, shorted elements, and leakage.

A SERVICE ENGINEER'S MANUAL INCLUDED in this amazing low price **\$795** net

**EBCO CHECKER-REACTIVATOR for Weak CR Tubes**

**Best Investment You Can Make:** This superb dual-purpose Checker-Reactivator will bring you a profit the first week you have it. **CHECKS TUBES** for shorts, cathode emission, leakage, etc. A fine dependable tester, plus—**ADDS NEW LIFE** to weak dim picture tubes. **Renews brightness, contrast, and detail.** FULLY GUARANTEED. Model 10 net **\$1995**



**EBCO "LIFE EXTENDER" for CR Tubes**

**Has Dual Heat Connection for dim and very dim tubes**

Works on all picture tubes, all sizes. Easily installed—just plug in. *Ideal for Servicemen with service contracts; often saves the cost of a new tube.* Has dual heat connection. Low in cost. List \$7.95; Net, \$2.95



**EBCO FIELD STRENGTH METER with Fringe Area Switch**

Range: 5 to 50,000 microvolts  
Improves TV installations - saves time and labor

Get better antenna orientation, better TV set performance, even in fringe areas. Measures field strength from 5 to 50,000 microvolts at the 300 ohm input terminals. Many other great features. Model 11 net **\$69**



**We are manufacturers of the finest Custom-Quality PICTURE TUBES**

Engineered to the highest standards. All EBCO tubes are new, individually checked, registered, and guaranteed. Substantial glass allowance on your used tubes, through your EBCO jobber.

**One Year Factory Guarantee**  
**Write for New Low Dealer Net Prices**

**We are Manufacturers and sell only thru Parts Jobbers**

Inquiries from Representatives Invited



ELECTRONIC BEAM CORP., 923 OLD NEPPERHAN AVE., YONKERS 3, N. Y.

present, just as in the open-circuited case. But this time the reflected voltage is going positive

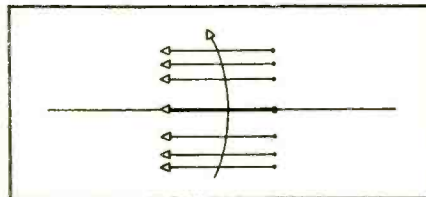

when the transmitted voltage is going positive, and the reflected voltage is going negative

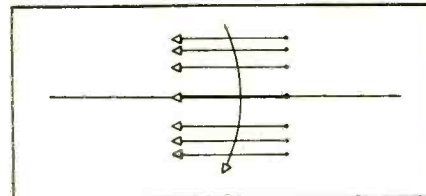

when the transmitted voltage is going negative. So whether we look at the combination of voltages at this point like this:

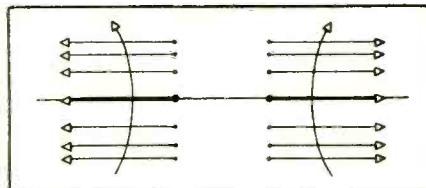

or this:

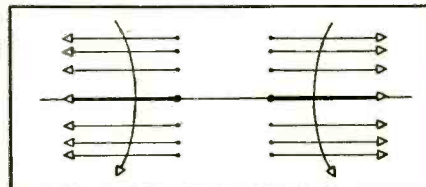

the two signals will always be aiding each other. Therefore, a quarter wave back from the end of a short-circuited transmission line the voltage is a maximum.

Now back up along the line from the end by another quarter wavelength, just as before. This time the reflected voltage at the new point is going negative

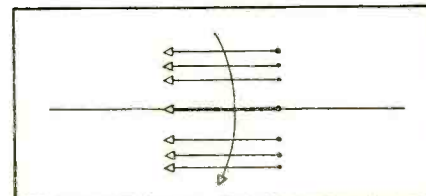

when the transmitted voltage is going positive, and the reflected voltage is going positive

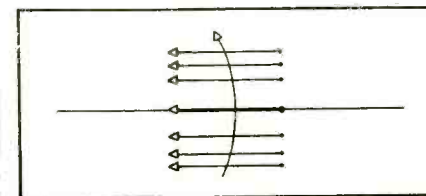

when the transmitted voltage is going negative. So whether the combination is viewed like this:



**FREE**  
 Your vacation may come  
 in this WALSCO  
 carton...

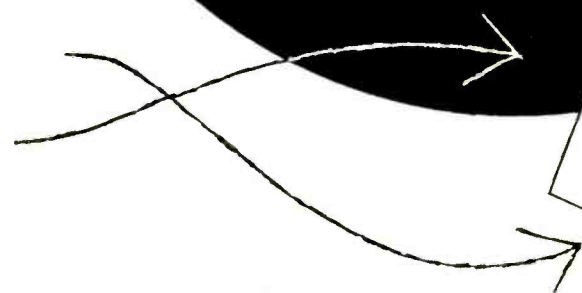

1,500,000<sup>th</sup>  
**WALSCO**  
 TV ANTENNA

The next quality antenna you buy, be sure to ask for WALSCO. You may be purchasing the lucky 1½ millionth antenna to be produced by WALSCO. Attached to it, you will find the winning certificate. Mail the certificate to WALSCO and you receive 2 tickets and all expenses to any vacation spot in America. Everything will be FREE. You will travel via luxurious TWA Constellation. WALSCO will arrange a thrilling vacation for you and your companion for one full week.

This is not a contest... nothing extra to buy. Just watch for the 1,500,000th WALSCO antenna. Your jobber may have the lucky antenna right now. It will come in a regular carton, with no special markings.

**Ask your jobber for WALSCO... it's America's quality antenna.  
 And you may win a fabulous FREE vacation for two.**

Travel FREE via  
 luxurious TWA  
 Constellation to any  
 vacation spot in America...  
*all expenses paid!*

**WALSCO**

**Walter L. Schott Co.**

3225 Exposition Place  
 Los Angeles 18, California

Overseas Representative

Ad Auriema, Inc.

89 Broad St. New York 4

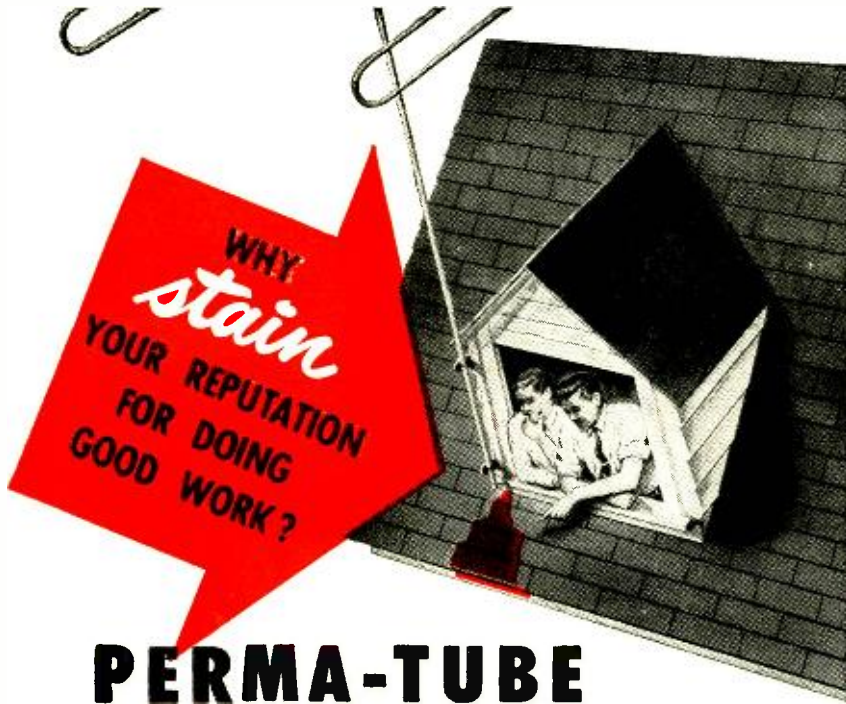

# PERMA-TUBE

## TV MASTS Are Corrosion-Proofed INSIDE AND OUT

It's said you can't tell a book by its cover. And it's tough to tell what's going on inside a TV mast until rust and water from corrosion leave an ugly streak on the roof or house wall—then it's too late.

That's one reason smart service men are guarding their reputations for good work by installing J&L PERMA-TUBE TV masts. PERMA-TUBE is completely protected against corrosion by being pre-treated with vinsynite and coated inside and out with an exclusive metallic-pigmented vinyl resin base. In addition—PERMA-TUBE is made of special high-strength J&L steel that stays up in storms that would flatten masts made of ordinary conduit and other types of tubing.

You can obtain PERMA-TUBE in standard lengths, diameters and wall thicknesses. It's easy and economical to install—PERMA-TUBE's new POSITIONED-FITTED joints can be slipped together in a matter of seconds.

### HERE'S INSIDE INFORMATION ON WHAT CORROSION DOES

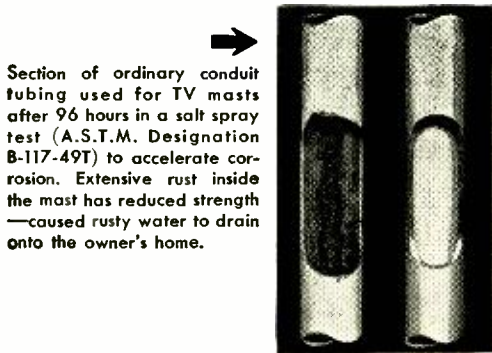

Section of ordinary conduit tubing used for TV masts after 96 hours in a salt spray test (A.S.T.M. Designation B-117-49T) to accelerate corrosion. Extensive rust inside the mast has reduced strength—caused rusty water to drain onto the owner's home.

Section of PERMA-TUBE after 500 hours salt spray test shows no evidence of corrosion. Strength has been retained and the chance of rust streaks on owner's home are eliminated. Note sturdier wall thickness of Perma-tube sample.

### FOR COMPLETE INFORMATION—MAIL THIS COUPON TODAY



Jones & Laughlin Steel Corporation  
496 Gateway Center  
Pittsburgh 30, Pa.

Without charge, please send me:  Name of Nearest distributor  
 Complete information on Perma-tube

NAME \_\_\_\_\_  
COMPANY \_\_\_\_\_  
ADDRESS \_\_\_\_\_

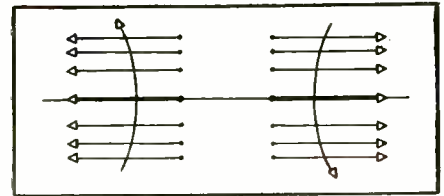

or this:

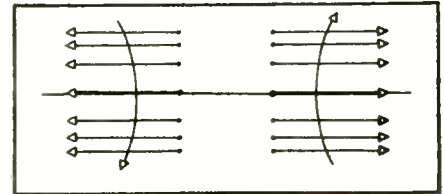

the two signals will always be in opposition and balance out to zero. Therefore, a half wave back from the end of a short-circuited transmission line the voltage is zero.

(You may ask: "Why is any signal reflected from a grounded-end transmission line? It is easy to understand reflection from an open-ended line—the electrons pile up and—having nowhere else to go—come back along the line. But why doesn't the signal just run into ground and disappear?")

The answer is easy. We have very large currents at the end of the line—the type we might expect at a short-circuit. These create a tremendous magnetic field around the line. When the signal has gone, the field collapses, producing a current that travels back along the line.)

With this short-circuited transmission line, a system of standing waves is found, similar to the open-circuited transmission line. And a similar general statement can be made: with a short-circuited transmission line, at all even-numbered quarter waves from the end the voltage is zero, at all odd-numbered quarter waves the voltage is a maximum. Plus, of course, the very end of the line where the voltage is zero.

The process for current is identical with that for the voltage, so there is no purpose to repeating the same details over again. The whole business can be put in one simple table:

VOLTAGE AT	OPEN CIRCUITED	SHORT CIRCUITED
ODD QUARTER WAVES	ZERO	MAXIMUM
EVEN QUARTER WAVES	MAXIMUM	ZERO

CURRENT AT	OPEN CIRCUITED	SHORT CIRCUITED
ODD QUARTER WAVES	MAXIMUM	ZERO
EVEN QUARTER WAVES	ZERO	MAXIMUM

That's all there is to getting a picture of what is happening along a transmission line. When properly terminated, all the energy in the line goes into the load with no reflection. But when the line is either open-circuited or short-circuited, a reflected signal is present which aids the transmitted signal at some points, and opposes the transmitted signal at other points.

This reflected voltage travels all the way back to the generator at the beginning of the line—but that's a complete story in itself, for another time. END



# POWER

your TV  
PICTURE  
with a  
**VEE-D-X**  
antenna

**ALL  
CHANNEL  
VHF-UHF**

**The Sensational ALL-CHANNEL Q-TEE**

with patented - printed circuit channel separators

**NEW RUGGEDIZED CONSTRUCTION**  
For positive element support the Q-Tee is now supplied with special reinforcing brackets, at no extra cost.

Brilliant all-channel performance in all multi-channel areas. The first antenna ever to employ printed circuit channel separators. The Q-Tee provides higher average gain than other broad band antennas and has higher uniform gain over all channels. Excellent front-to-back ratio - perfect 300 ohm match and lower standing wave ratio. Easily installed and has excellent rooftop appearance. Small and light in weight, yet features "ruggedized" construction. Available in three series - Q-Tee Single Bay for primary areas; Q-Tee Double for near-fringe areas; Q-Tee Quad for fringe areas.

\* Lic. A. A. K. Pat. 2,422,458; 2,282,292, others pending

**The New ULTRA Q-TEE**

**2-83**

**THE FIRST ALL-CHANNEL VHF-UHF ANTENNA**

Install the Ultra Q-Tee now for VHF - and it's ready for UHF. It gives brilliant reception on every TV channel from 2 to 83 using one transmission line, eliminating the need for two or more antennas with multiple lead-ins and switches.

the sensational **NEW LONG LONG JOHN**



**SUPER HIGH GAIN 12-ELEMENT YAGI**

Here is the highest gain single-channel antenna ever developed. Provides grand slam power for fringe areas. Guaranteed to outperform all others. New "rigidized" boom bracing gives extra strength. Pre-assembled for fast, easy installation. Can be stacked for extra gain.



Here are the finest **SINGLE CHANNEL ANTENNAS** ever perfected!

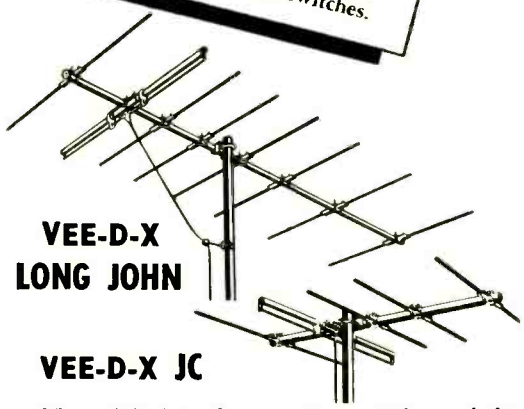

**VEE-D-X LONG JOHN**

**VEE-D-X JC**

The original 8-element Long John and the famous 5-element JC outperform and outsell all others. There is a Vee-D-X Yagi for every installation requirement in all single-channel areas.

THE LaPOINTE-PLASCOMOLD CORP RE 10  
ROCKVILLE, CONNECTICUT

Send full details on the following:

- All-channel Q-Tee
- Ultra Q-Tee
- Long John
- Long Long John
- JC Yagi
- New Catalog

NAME .....

ADDRESS .....

CITY..... ZONE..... STATE.....

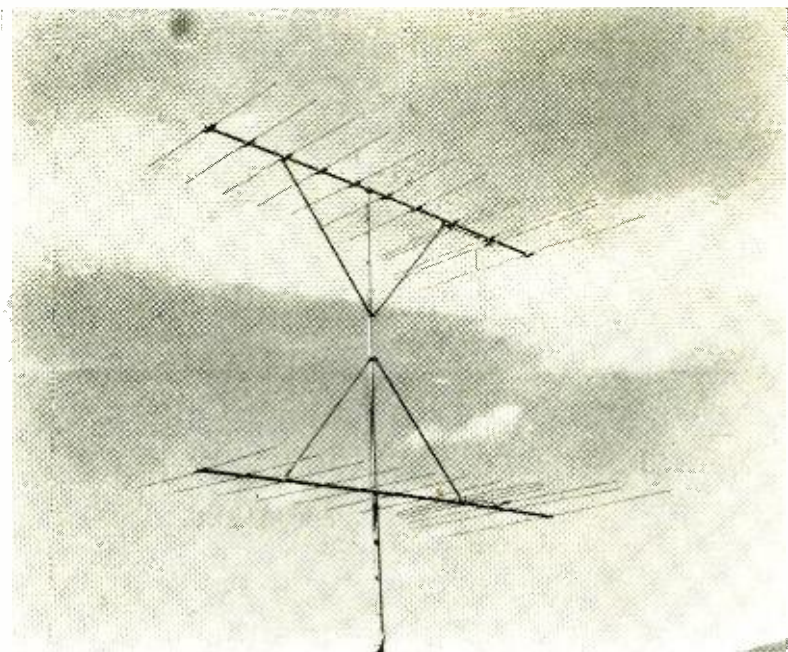

# FUTURAMIC ANTENNA

has Yagi gain and directivity plus multi-channel coverage

By HAROLD HARRIS\* and HARRY GREENBERG\*\*

THE recent end of the television freeze means that hundreds of new v.h.f. stations will be going on the air in the near future. It also means that 30 of the present stations will have to change channels. One of the many problems created by this change and expansion is the need for new types of antennas.

In the past two years the Yagi has become one of the most popular fringe-area antennas. Despite its high gain and excellent directivity it has one serious limitation. The Yagi will work on only one or possibly two channels. Wherever existing channels are changed or new v.h.f. stations are added, present Yagi antennas will have to be augmented or replaced. All new installations will have to provide for future channels.

What is needed is an antenna with

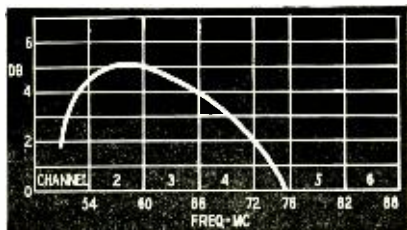

Fig. 1—Folded dipole-reflector response.

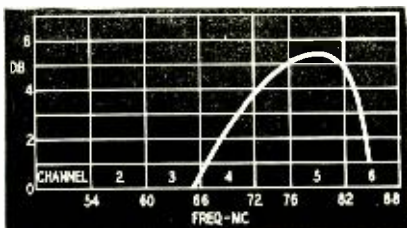

Fig. 2—Folded dipole-director response.

the outstanding gain, directivity, and structural qualities of the Yagi plus the ability to cover a number of chan-

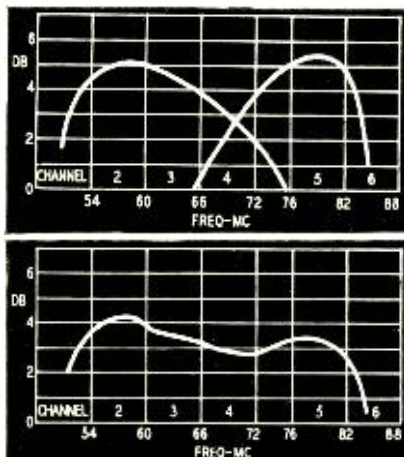

Fig. 3-a (above)—Matched dipole-reflector (low end) and dipole-director (high end). Fig. 3-b (below)—Overall response of the combination.

nels. This article explains the theory and operation of a commercial broadband Yagi antenna, the Channel Master Futuramic.

## Parasitic antennas

It will be helpful to review some of the characteristics of parasitic antenna systems. The gain curve for a folded dipole with reflector cut for a specific channel is shown in Fig. 1. Its response falls off sharply at the low end, but the high-frequency end extends over two additional channels with gradually diminishing response. A folded dipole with director (Fig. 2) has slightly higher gain than the reflector type, but differs in two important respects: First, its bandwidth is not as great; and second, its response drops sharply at the high end, and gradually at the low end.

Fig. 3 shows how these characteristics are used in the Futuramic antenna. A folded dipole and reflector cut for channel 2 is combined with a folded dipole and director cut for channel 5. The opposite slopes of the two antennas in the center of the band (3-a) give uniform sensitivity over channels 2, 3, 4, and 5 (3-b). The same principle enables two dipoles of proper length to cover the entire high band (channels 7-13).

## Adding directivity

The next step was to make the combination unidirectional. Fig. 4 illustrates the basic principle used in the Futuramic antenna. Dipoles A and B are cut respectively for the low and high ends of the band to be covered. They are spaced 45 electrical degrees (one-eighth wavelength) at the mid-band frequency, and are connected by a section of transmission line 135 degrees (three-eighths wavelength) long.

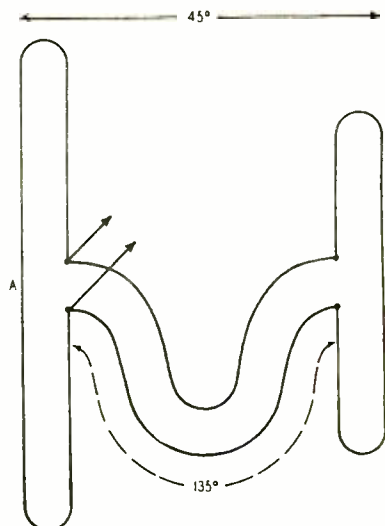

Fig. 4—Basic Futuramic dipole spacing.

\* Vice-president, Sales & Engineering, and  
\*\* Chief Development Engineer,  
Channel Master Corp., Ellenville, N. Y.



# What a profit-making pair!

**THE IDEAL COMBINATION  
FOR TV DEALERS**

## ALLIANCE TENNA-ROTOR THE TV ANTENNA ROTATOR

FOR  
V.H.F.



Model  
HIR

**ALLIANCE TENNA-ROTOR** is the proved favorite antenna rotator! Has outsold every other TV accessory. Tops for highly directional U.H.F. So when you sell 'em Tenna-Rotor, they're ready for tomorrow! Model HIR is fully automatic. Set it and forget it!

## ALLIANCE CASCAMATIC THE AUTOMATIC TV BOOSTER



**ALLIANCE CASCAMATIC**, the new automatic TV Booster. Uses the famous "California Circuit." Pre-tuned to all channels. Mounts on back of set, out of sight. Easily installed by anyone. Adds three tubes to set—steps up both picture and sound—gets more distance.

## SOLD THE MOST BECAUSE THEY'RE SEEN THE MOST!

CUSTOMERS SEE 'EM ON TV . . . SEE 'EM IN NEWSPAPERS

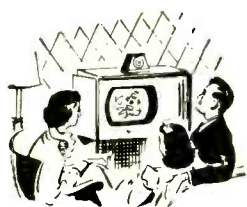

This Fall selling Alliance TENNA-ROTORS and Alliance CASCAMATIC is a cinch! Millions of people will continue to see convincing TV demonstrations and newspaper

advertising . . . powerful selling impressions that deliver that impulse to buy. It pays to display Alliance products because they're seen the most and sold the most.

**THE ALLIANCE MANUFACTURING COMPANY • Alliance, Ohio**

Depend on...  
**CONCORD**  
 for BEST  
**VALUES!**

**AMAZING BARGAIN!**  
 CUSTOM BUILT AUTO RADIO  
 Dodge-Plymouth \$ **32.50**  
 No. RC-G0TH2  
 Limited Quantity...

Custom designed, especially for '51-'52 Plymouth, Dodge, 8-Tube super. 2 Separate chassis for tuner and power supply. Complete with cables, instructions. Ship. wt. 15 lbs. Superior to similar sets selling for several times this low price!

**Sensational SESSIONS  
 CLOCK TIMERS**

Turns radios, TV sets, etc., on or off automatically. Ideal replacement for old clock radio. Controls include: on-off, switch set, time set, ringing alarm, 110 V 60 cy. AC, 10 Amp. switch contact, 3 1/2" face.  
 No. RC-W43 with "Tru-hel" alarm, round face...\$7.50  
 No. RC-W318 Square face, less alarm...\$6.50  
 No. RC-W319 Round face, less alarm...\$6.50



**Yes, you'll find these wonderful buys — and thousands more, in the new CONCORD Buying Guide.**

**DEPEND ON CONCORD, for:**

- The latest in Radio, Electronic & TV Sets, Sound Systems, Ham Equipment, Components, Accessories, Standard Merchandise and SPECIAL BUYS!
- Fast, efficient, courteous Counter Service — High-g geared Mail-order Department — a Ham Section manned by HAMS, ready to help you!

Send TODAY for your copy of our latest Buyer's Guide.

**CONCORD RADIO**  
 55 Vesey St., New York 7.



and it's **FREE** for the asking

CONCORD RADIO, 55 Vesey St., N. Y. 7 Dept. C-10  
 Send me at once your latest Buyer's Guide, Free of Charge.

Name .....  
 Address .....  
 City ..... State .....

The antenna feed points are at the terminals of dipole A.

A signal from the left hits dipole B through space 45 degrees after it hits dipole A. This signal is then fed back from B through the line section, which shifts the phase an additional 135 degrees. The feedback signal reaches dipole A 180 degrees out of phase with the original signal. Thus signals from the left cancel at the feed point. (Fig. 5-a)

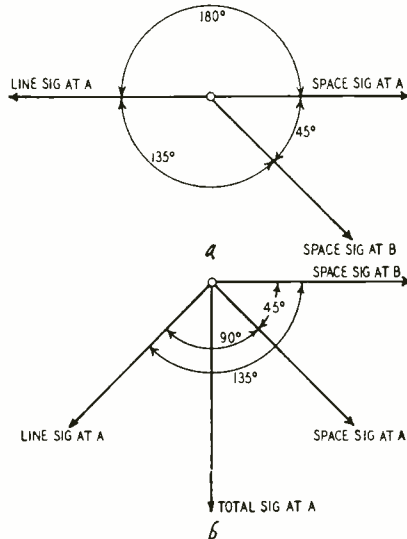

Fig. 5—Phase relationships in spaced dipole system: (a) signals coming from left; (b) signals arriving from right.

A signal from the right hits dipole B first. The space signal hits dipole A 45 degrees later, but the signal traveling through the line from B to A is shifted 135 degrees. As a result, two equal signals reach A 90 degrees (135 minus 45) apart, and their sum is 1.4 times

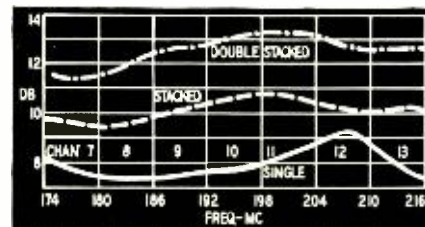

Fig. 6—Response of high-band type. the original signal. (Fig 5-b.) The basic two-dipole network thus has a 40% voltage gain (3 db) forward and rejects signals from the rear.

In the commercial models, the trans-

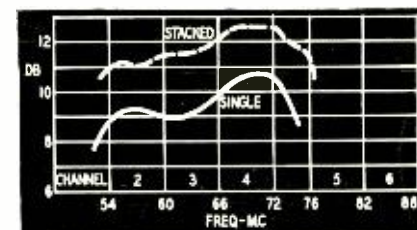

Fig. 7—One- and two-bay response curves for 3-channel Futuramic. mission-line section is actually 60 degrees (one-sixth wavelength) long, with the feed points 45 degrees from dipole B. This compensates for the inductive signals, and for the capacitive reactance of dipole A on higher-channel of dipole B on lower-channel signals.

**Increasing forward gain**

Fig. 3-b shows that the natural sensitivity of the two-dipole system is greatest at the low-frequency end of the band. A single reflector element (behind the low-frequency dipole) raises the forward gain at the low end about 4 db. Additional reflectors do not give any substantial increase in sensitivity. Seven director elements provide high gain at the high end.

A single Futuramic covers the entire

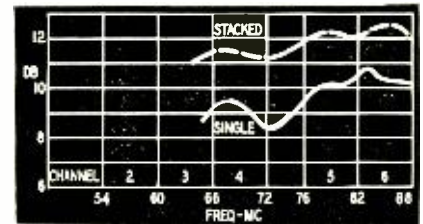

Fig. 8—One- and two-bay response of another 3-channel low-band Futuramic. high band (channels 7-13) and models were designed for covering either three or four channels of the low band. Gain curves for single and stacked antennas are shown in Figs. 6 through 10. In these figures, the terms stacked and double-stacked refer to 2-bay and 4-bay antennas, respectively. The high-band antenna can be stacked in four bays.

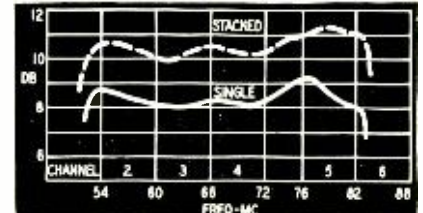

Fig. 9—Response of Futuramic 4-channel low-band model with 1 and 2 bays.

Note that antenna gain increases with frequency. This offsets the higher losses in the lead-in, and tends to keep the voltage fed to the receiver constant for all channels in the band.

The significant stacking gains were achieved by using the Channel Master Z-Match system. Most television antennas are stacked with 3/8-inch tubing, spaced 3 inches to give a characteristic

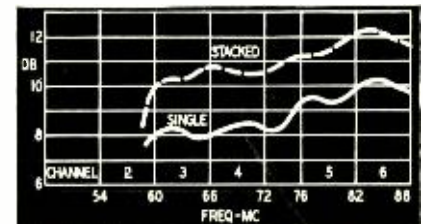

Fig. 10—Another 4-channel model.

impedance of 325 ohms. Since Yagi antennas are stacked a half-wave apart, the stacking bars function as a pair of quarter-wave transformers, transforming the impedance of each antenna to a different value at the feed points in the center of the bar. The formula for the transformer is  $Z_{N1} = \sqrt{Z_i \times Z_o}$ , where  $Z_{N1}$  is the impedance of the matching section (stacking bars),  $Z_i$  is the input (antenna) impedance, and  $Z_o$  is the output (line) impedance.



FOR THE FIRST TIME... **ANYWHERE!**

A BROAD-BAND, 3-TUBE, 3-STAGE,  
FULLY AUTOMATIC BOOSTER WITH  
ALL-CHANNEL GAIN IN EXCESS OF 16 db.

and only  
**\$39<sup>50</sup>**  
LIST



THE NEW **B-T**  
**BOOSTER**  
MODEL HA-3 Fully Automatic

Designed and Manufactured by  
Blonder-Tongue Laboratories for  
Better Television

NO Knobs to Set  
NO Tuning  
NO Band-Switching

COMPARE THESE SUPERIOR FEATURES:

- ★ Fully Automatic Broad Band Performance . . . NO Tuning.
- ★ Fully Automatic 'On and Shut-off' Power Control.
- ★ Full UHF Adaptability.
- ★ Gain on all channels in Excess of 16 db. Plus Attenuator Switch.
- ★ 3-Tube, 3-Stage Cascade push-pull Circuit.
- ★ Lower Noise Factor.

Standard RTMA Warranties Apply

Specify **B-T** Amplifiers and Accessories  
for Easy-to-Install Master TV Systems

Write for complete Data.



**BLONDER-TONGUE LABORATORIES, INC.**  
WESTFIELD, NEW JERSEY

# TRIO ANNOUNCES SENSATIONAL NEW ZIG-ZAG ANTENNA

Patent Pending

- ★ Higher Gain than any Yagi!
- Plus
- ★ All-Channel VHF Performance!

Here's the greatest advance in TV antennas since TRIO'S introduction of the dual channel yagi! The sensational new TRIO ZIG-ZAG antenna is basically a multiple element yagi type antenna on each channel, yet one 2-bay antenna — and in some models a single bay antenna — covers all VHF channels!

This sensational antenna has sharper directivity and higher front-to-back ratio. It provides snow-free pictures, and fade-free sound even in the most remote fringe areas.

Tremendous forward gain is accomplished without long, bulky, arrays that operate on only one channel. With the new fringe area model ZIG-ZAG antenna, one bay provides tremendous gain on all low channels, 2 thru 6, and the other bay provides similar high gain on channels 7 thru 13.

### HOW THIS AMAZING ANTENNA WORKS

Trio ZIG-ZAG antennas utilize a new principle whereby an array is composed of a series of elements, one or more of which is resonant on any one channel while the remaining elements, which are non-resonant on that channel, provide parasitic voltages having the proper phase relative to the direct voltage. These act as very efficient directors and reflectors. All elements are directly connected to the feed-line.

The various models, listed below, are designed to provide a simple installation for all areas, from metropolitan to extreme fringe. Two bay models, like the single bay models, are operated with a single 300 ohm lead-in to the set, with less than a 3:1 standing wave ratio.

### 8 MODELS FROM WHICH TO CHOOSE:

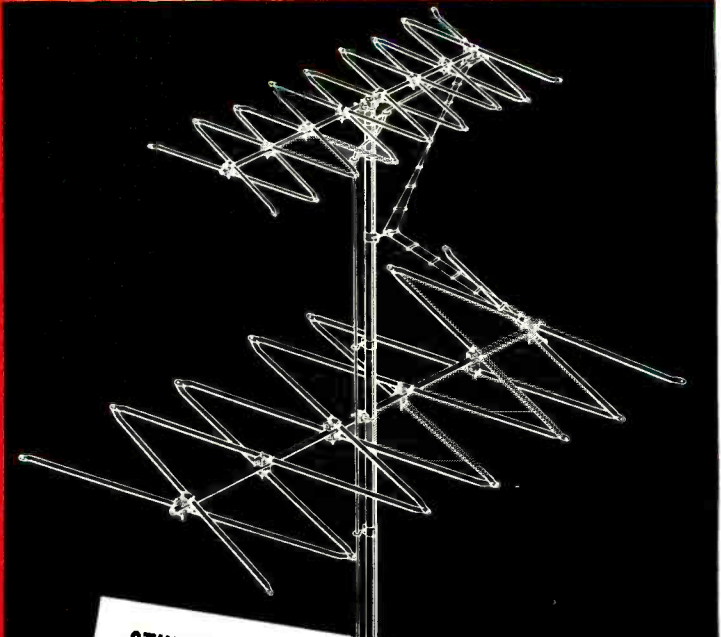

**STURDY, VIBRATION-PROOF CONSTRUCTION**  
 Rugged strength is designed into all models. Antenna is shipped with all hardware mounted on the boom with the exception of the mast clamp. Complete assembly consists only of matching color-coded elements to the color-coded boom and tightening nuts which furnish clamping action. Complete assembly is accomplished in minutes.

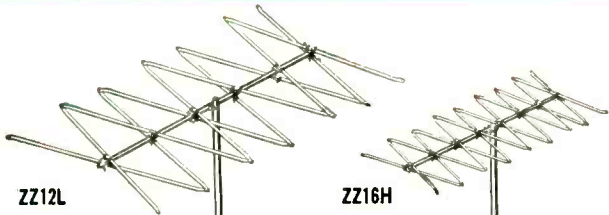

ZZ12L

ZZ16H

FOR EXTREME FRINGE RECEPTION — ZZ16H provides over 14 DB voltage gain as compared with a resonant reference dipole on Channels 7 thru 13; and ZZ12L provides gain of 12 to 14 DB on Channels 2 thru 6. Gain of the ZZ12L is 12 DB on Channels 2 and 3 and is 14 on Channels 4, 5 and 6. These models have narrowest forward lobe and highest front-to-back ratio and should be used in areas where co-channel interference is a problem.

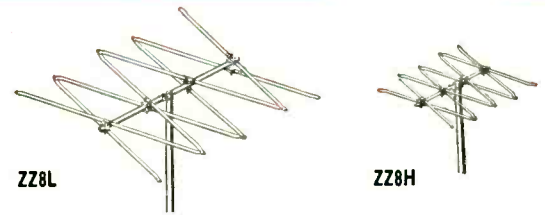

ZZ8L

ZZ8H

FOR NORMAL FRINGE RECEPTION — Where maximum gain is not necessary, these models are ideal. The ZZ8H for Channels 7 thru 13 and the ZZ8L for Channels 2 thru 6. Voltage gain is 9 DB on Channels 2 and 3 and 11 DB on Channels 4 thru 13. These models have patterns comparable to a well designed multi-element single channel yagi.



WRITE FOR CATALOG

ZZ6L

ZZ6H

FOR NEAR FRINGE RECEPTION — These models provide a voltage gain of 8 to 9 DB on Channels 2 thru 13. These models have pattern and gain comparable to a cut-to-channel yagi. ZZ6L covers Channels 2 thru 6. ZZ6H covers Channels 7 thru 13.

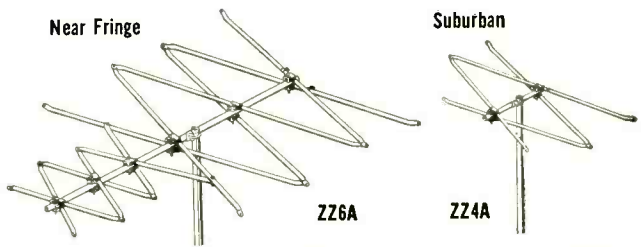

Near Fringe

Suburban

ZZ6A

ZZ4A

SINGLE BAY ALL-CHANNEL RECEPTION — Model ZZ4A is a single bay antenna providing adequate gain and directivity on all channels, 2 thru 13, in suburban areas. Model ZZ6A is also an all-channel single bay antenna providing greater gain for near fringe use.



TRIO MANUFACTURING COMPANY • GRIGGSVILLE, ILLINOIS



# The TRIO ROTATOR

*Easy to Sell!*

It's easy to sell a product with as many plus features to talk about as the TRIO ROTATOR. In design, in construction, appearance; it is by far the outstanding TV antenna rotator in the market today!

*Stays Sold!*

In addition to providing a powerful sales story, the features listed below are your assurance of complete customer satisfaction: Assurance that the TRIO ROTATOR will give dependable performance year in and year out — in all kinds of weather!

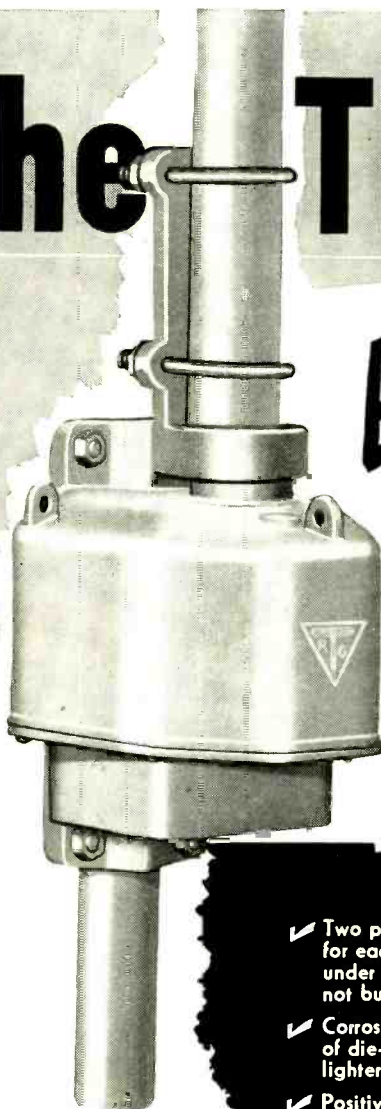

- ✓ Two powerful 24 volt motors used — one for each direction of rotation. Each motor under load only fraction of time — will not burn out!
- ✓ Corrosion resisting, weatherproof housing of die-cast aluminum for greater strength, lighter weight, perfect alignment of parts!
- ✓ Positive electrical stops at ends of 360° rotation prevent damaging or twisting of leads!
- ✓ Will support heavy TV arrays — even in 80 MPH winds!
- ✓ Permanently lubricated with special grease that functions perfectly in high and low temperature extremes!
- ✓ Ball-bearing end thrusts on all shafts, including motor! Main shaft vertical load carried on large oversized "Oilite" self-lubricating bearing!
- ✓ All motors, shafts and gears mounted on a rugged, one-piece casting for true alignment and longer life!
- ✓ 1 1/16" diameter tool steel main shaft and mast holder will withstand 4500 inch pounds bending moment!
- ✓ Rotator and mast holder fits any pipe size up to 2" OD!
- ✓ Precision built to extremely close tolerances!



*Smartly Styled*

## DIRECTION INDICATOR

The TRIO Direction Indicator is housed in a sturdy plastic cabinet of graceful lines. It is a beautiful instrument that will blend harmoniously with any furniture style.

Utmost ease in selecting the desired antenna direction is provided by a new "finger tip" control that operates at a light touch and the easy-to-read dial face that clearly and instantly indicates the exact antenna position.



## FULLY TESTED BEFORE SHIPMENT

Each TRIO ROTATOR is thoroughly factory tested to the equivalent of 3 months of constant operation. This, plus an additional torque test guarantees each unit to be perfect in every detail of assembly.

The TRIO ROTATOR's sound design and construction has been proven by three years of extensive field testing under every extreme of weather.



**TRIO** Manufacturing Company  
GRIGGSVILLE, ILLINOIS



**NEW GOODLINE AIRLEAD has everything you want!**

- Sharp, clean, "snow-free" pictures.
- Correct impedance for "ghost-free" reception. Nominal 300 ohms.
- Lower in cost than other leadlines purported to accomplish same results.
- Correct spacing for minimum radiation loss—Less than 1% of operating wave length.
- Fully insulated—approved by safety experts.
- Pure, unadulterated polyethylene insulation — specially treated by our chemists for extreme weather.
- High-efficiency conductors: Flexible, stranded — to insure long life.
- Easily installed—with standard insulators.
- Packaged in convenient lengths: 100', 250', 500', 1,000', 2,500'.
- AT YOUR DEALERS, or Write For Free Samples and Literature.

\*Patent Pending \*Trade Mark U.S. and Foreign Patents Pending  
**EXCLUSIVE LICENSEE AND SOLE MANUFACTURER**

**Don Good, INC.**

1014 FAIR OAKS AVENUE  
 SOUTH PASADENA, CALIFORNIA

**OTHER OUTSTANDING GOODLINE PRODUCTS:**

**VARIABLE TELETRAPS-2:** Highly effective for eliminating interference from FM STATIONS, and DIATHERMY and AMATEUR SIGNALS within its tuning range.

**HI-PASS FILTER:** Eliminates or greatly reduces interference picked up by I. F. AMPLIFIER or TV RECEIVER — interference arising from strong, local low-frequency fields: X-Ray, Diathermy Equipment, Neon Lights, Etc., Etc.

**WANTED**

BD110 Telephone Switchboards, BD100 Telegraph Switchboards, BD90 Power Boards, EE101 V-F Rings, BE72 Cabinets, FM19 Frames, RA43, REC30, KS5988, RA87, RA37, RA91 Rectifiers, BD101 Test Boards, SB6 Switchboards, Type CF1A, CF3A, CF2B Carrier Equipments. Any condition and quantity.

Box 752-1 Radio Electronics  
 25 W. Broadway, New York 7, N.Y.

From the earliest days of Radio . . .  
 to the present era of Television . . .

**CORNISH WIRES**

"Made by Engineers for Engineers"  
 CORNISH WIRE CO., Inc. — 50 Church St., N. Y. C. 7

**WANT REPRINTS?**

Offset reproductions of any of the fine articles appearing in RADIO-ELECTRONICS supplied! Excellent work, low cost! Orders for reprints accepted in any quantities over 100. Write for an estimate.

**PASSANTINO PRINTING CO.**  
 250 West 49th St. New York 19, N. Y.

**Every RADIOMAN can use these SERVICE HINTS!**

Valuable Manual Yours—FREE  
 Write today, no obligation  
**FEILER ENGINEERING CO. Dept. 10RC2-1**  
 8020 W. Monticello Ave., Skokie, Ill. (Suburb of Chicago)

Every page of "How to Simplify Radio Repairs" is packed with on-the-bench, practical ideas.

When two 300-ohm Yagis are stacked with 325-ohm matching transformers, each Yagi is transformed to 350 ohms at the feed points. The two 350-ohm impedances in parallel equal 175 ohms, a mismatch of almost two to one (see Fig. 11-a). In the Z-Match system, the center bar is taken out of the rear folded

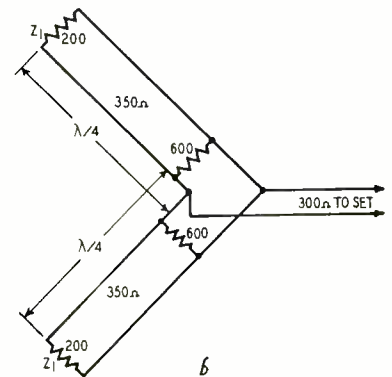
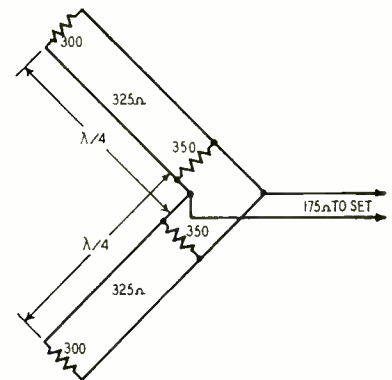

**Fig. 11—Yagi stacking methods: (a) Conventional stacking with 300-ohm antennas and 325-ohm bars. (b) Channel Master Match system, using 200-ohm antennas and 350-ohm bars.**

dipole, lowering the impedance of the array to 200 ohms. Stacking bars (quarter-wave transformers) are spaced to have 350 ohms impedance. The 200-ohm antennas are raised to 600 ohms each at the feed points. The two 600-ohm impedances in parallel total 300 ohms to match the transmission line (Fig. 11-b).  
 END



"We've been getting a lot of snow on our picture!"



# A Guiding Beacon For Quality Electronic Parts

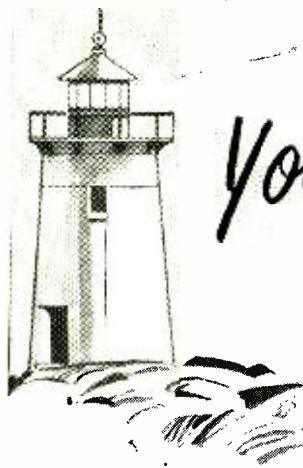

Your Local  
**RADIART**  
Distributor



## RADIART Sales Offices Across The Nation

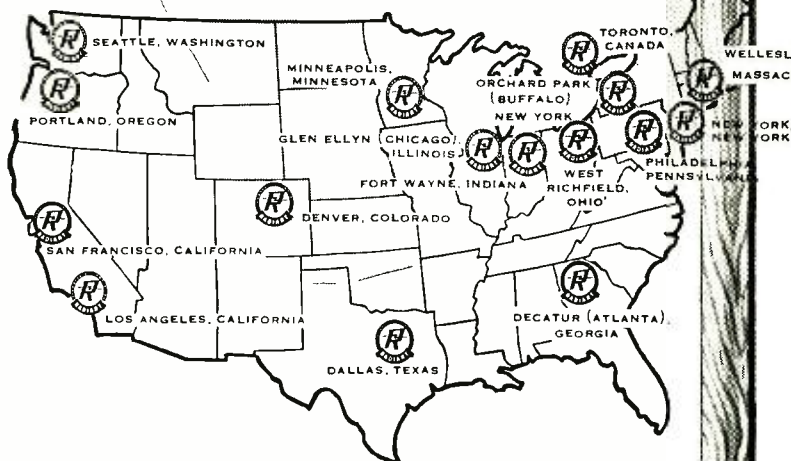

These Are The Cities With RADIART Distributors  
In Arkansas, Louisiana, Oklahoma and Texas.

### ARKANSAS

- BLYTHEVILLE
- FORT SMITH
- LITTLE ROCK
- PARAGOULD
- TEXARKANA

- NEW ORLEANS
- SHREVEPORT

### OKLAHOMA

- OKLAHOMA CITY
- TULSA

### CORPUS CHRISTI

- DALLAS
- DENISON
- FORT WORTH
- HOUSTON
- LAREDO
- LUBBOCK
- McALLEN
- SAN ANGELO
- SAN ANTONIO
- TYLER
- WACO
- WICHITA FALLS

### LOUISIANA

- ALEXANDRIA
- BATON ROUGE
- LAFAYETTE
- LAKE PROVIDENCE
- MONROE

### TEXAS

- ABILENE
- AMARILLO
- AUSTIN
- BEAUMONT
- BIG SPRING
- BROWNSVILLE

## BUY OF THE MONTH



The CDR ROTOR... model TR-12 offers all you could ask for in an antenna turning device! It will support and turn with ease any TV antenna array...and has a handsome modern design plastic cabinet with meter control dial and finger-tip lever. Other features include speedy installation with no loose parts to assemble... 4 wire cable installation... quick mounting antenna mast collet and is dependable and trouble free in operation. See them at your jobber or write for literature.

FOR NAME OF YOUR NEAREST RADIART DISTRIBUTOR  
USE COUPON BELOW

RADIART SALES CO., 1431 Pleasant Drive, Dallas 17, Texas

.....Please send names of the Radiart Distributors in my area stocking the following Radiart products in which I am interested:  Rotors,  Vibrators,  TV and FM Antennas,  "Spee-Dee" Chimney Mounts,  Lightning Arresters,  Auto Aerials,  Power Supplies

.....Please have a Radiart Distributor call on me.

Name.....  
Address.....  
City..... State.....



# THE RADIART CORPORATION CLEVELAND 2, OHIO

BOOSTERS • VIBRATORS • AUTO AERIALS • TV ANTENNAS • ROTORS • POWER SUPPLIES

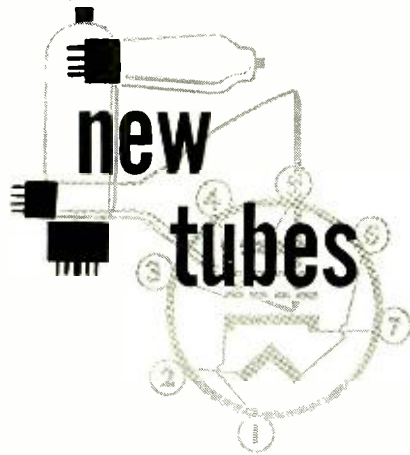

General Electric type GL-5965 is a miniature twin triode for use in digital computers. It is the companion tube to the GL-5844, which is used on a large scale in industrial computing devices.

Both types have a special heater-cathode construction designed for dependability under frequent "on-off" switching conditions. The cathodes will maintain their emission capabilities even after long periods of operation

under cutoff conditions.

Each triode section has high zero-bias plate current and a sharp cutoff characteristic. In addition, the cutoff characteristics of the two sections are closely matched. The GL-5965 has about twice the output of the GL-5844.

Average characteristics for each triode section of the GL-5965 with 150 volts on the plate: Heater, 6.3 volts at 0.45 amp, or 12.6 volts at 0.225 amp; cathode bias resistor, 220 ohms; amplification factor, 47; plate resistance, 7,250 ohms; transconductance, 6,500 micromhos; plate current, 8.2 ma.

In computer service the GL-5844 has the following characteristics: Heater, 6.3 volts at 0.3 amp. (each triode): plate supply, 150 volts; plate load resistor, 20,000 ohms; grid resistor, 47,000 ohms. "On" condition: grid voltage, 0; plate current, 4.8 ma minimum. "Off" condition: grid voltage, -10; plate current, 0.1 ma maximum.

G-E has also announced a 15-kilowatt Klystron tube for u.h.f. television transmitters. The 15-kw rating assures exceptionally good linearity at a peak signal (sync) output of 12 kilowatts. The new tube requires less than 100

watts of driving power, and can be sup-

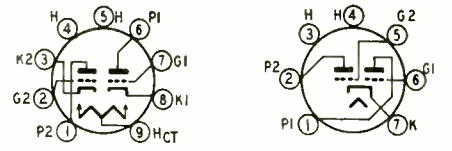

GL-5965 GL-5844  
Basing diagrams of GL-5965 and 5844.



GL-5965 twin triode for computer use.

**BUY DIRECT  
and SAVE!**

**STEVE-EL  
CUSTOM-  
MADE TV CABINETS**

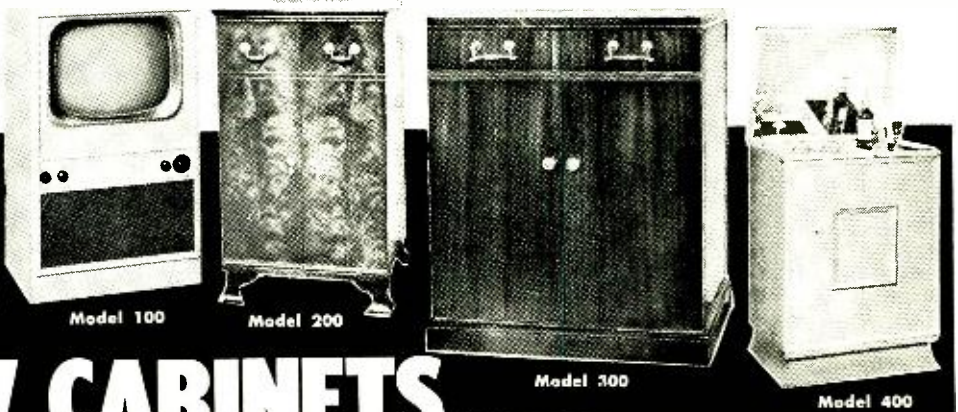

Cabinets are designed and built by country's leading craftsmen. Custom-Made and designed for standard 630 type chassis with 20" picture tube. All cabinets supplied with mask and mounting brackets. (Hardware appointments subject to change depending on availability).

- Model 100—Open face console, mahogany ..... \$55.00
- Model 200—Console with doors. Narrow type, mahogany ..... \$79.00
- Model 300—Side Mount console with doors, mahogany ..... \$89.00
- Model 400—Console with bar, blond only ..... \$136.50

**BUY THIS COMBINATION DEAL  
AND SAVE STILL MORE!**

Choose cabinet in combination with famous 630TV chassis and 20" picture tube. Note the additional saving passed on to you!

Cabinet Model	#100	#200	#300	#400
CASCADE Chassis	\$219	\$239	\$249	\$295
DF CASCADE Chassis	\$229	\$249	\$259	\$305

*Also includes 20" picture tube.*



**SUPER DELUXE  
630 TV CHASSIS**

Finest component parts. Takes all picture tubes from 16" to 24". Complete with 12" speaker. Manufactured under RCA license. With CASCADE TUNER ..... \$138.50  
With SUPER DF CASCADE TUNER ..... \$151.95  
(Specially designed for fringe area reception)

- TV PICTURE TUBES. ALL
- Brand New STANDARD
- BRANDS—NO REBUILTS!
- ONE FULL YEAR GUARANTEE
- 14BP4 ..... \$19.95
- 16GP4 ..... 26.00
- 16KP4 ..... 23.40
- 17BP4 ..... 23.40
- 19AP4 ..... 23.95
- 20CP4 ..... 32.00
- 21EP4 ..... 34.40
- 24AP4 ..... 59.60

Write Dept. RE-10 for latest catalog and complete list of tubes on special sale.

**STANDARD BRAND TUBES** Individually Boxed and Guaranteed

(Manuf. of tubes refuses permission to mention name because tubes are FAIR BELOW FAIR TRADE).

1A7	.89	6AG5	.79	6CB6	.71	6X5	.62	12SQ7	.68
1B3	.89	6AH6	1.29	6CD6	2.39	7C5	.74	14A7	.84
1H5	.71	6AK5	1.29	6J5	.54	7F7	.74	14B6	.94
1N5	.74	6AL5	.68	6J6	.94	7K7	1.09	25BQ6	1.29
1R5	.79	6AQ5	.59	6K6	.66	7N7	.84	25L6	.64
1S5	.79	6AT6	.68	6K7	.74	12AT6	.65	29W4	.78
1T4	.79	6AU6	.69	6SA7	.64	12AT7	.99	25Z6	.67
1U5	.78	6BA6	.69	6SH7	.64	12AU7	.86	35L6	.86
1X2A	.94	6BC5	.74	6SJ7	.74	12AV7	1.19	35W4	.52
3Q4	.89	6BE6	.79	6SK7	.72	12AX7	.99	35Z5	.51
3Q5	.89	6BG6	1.76	6SL7	.74	12BA6	.69	50A5	.96
3V4	.73	6BH6	.86	6SN7	.74	12BE6	.69	50B5	.79
5U4	.63	6BK7	1.15	6SQ7	.64	12BH7	.99	50C5	.66
5V4	.97	6BQ6	1.24	6T8	.99	12SA7	.77	50L6	.64
5V3	.47	6BQ7	1.15	6V6GT	.64	12SK7	.77	117Z3	.64
6AC7	.94	6C4	.54	6W4	.64	12SN7	.84		

Above partial listing only. Send for complete list.

**STEVE-EL ELECTRONICS CORP.**  
61 READE ST. NEW YORK 7, N. Y.  
Cortlandt 7-0086



plied for any frequency from 470 to 890 megacycles, to meet the requirements of TV transmitter manufacturers.

This is the second integral-cavity u.h.f. Klystron developed by Varian Associates of San Carlos, Calif., to General Electric specifications. The first, a five-kilowatt unit, was operated experimentally at Electronics Park for nearly a year.

The Cathode-ray Tube Division of Allen B. Du Mont Laboratories, Inc., has developed a new line of cathode-ray tubes employing electrostatic focus and magnetic deflection, primarily for radar installations.

The new tubes are: B1036P-, B1038P-, B1039P-, B1040P-, and B1056P-, which replace respectively the Types 5FP-, 10KP-, 12SP-, 12DF-A, and 7MP.

The new electron lens gives more uniform spot size and improves resolution considerably. Substantially automatic focus is achieved if the focusing electrode is operated at cathode potential.

In addition to their other advantages, these tubes require only -15 to +25 microamperes focus current compared to 118 to 161 milliamperes focus-coil current for equivalent magnetic types.

The reduced power requirements and the elimination of the focus coil are extremely important considerations in airborne radar, and allow substantial savings in copper. A newly designed glass-rod support for the electron-gun maintains spacing more accurately and makes these tubes much more resistant to vibration than earlier types.

Sylvania's new instant-firing ATR tube, type 6214, will permit the manufacture of more compact and less costly beacon radar equipment. A beacon located at a known point receives a radar signal from an approaching plane or ship and automatically transmits a coded answering signal which enables the vessel to determine its direction and distance from the beacon.

In radar systems using a common antenna for transmitting and receiving, the TR (transmit-receive) tube and its companion the ATR (anti-transmit-receive) protect the ultra-sensitive receiver from being damaged by the high-power transmitter signal; and prevent the weak reflected signal from being absorbed in the transmitter during reception.

Conventional ATR tubes often fail to operate immediately when the transmitter starts, preventing proper transmission for possibly several seconds. Therefore, beacon systems have been engineered without ATR tubes, making separate transmitting and receiving antennas necessary. Type 6214 is capable of instantaneous operation on the first code pulse from the transmitter.

With an instant-starting ATR tube now available, a single antenna will handle both the receiving and sending functions.

The instant starting feature of the new tube has been achieved by adding an ignitor electrode to the end plate of the tube. The power supply for this ignitor is taken from the supply for the TR tube ignitor. END

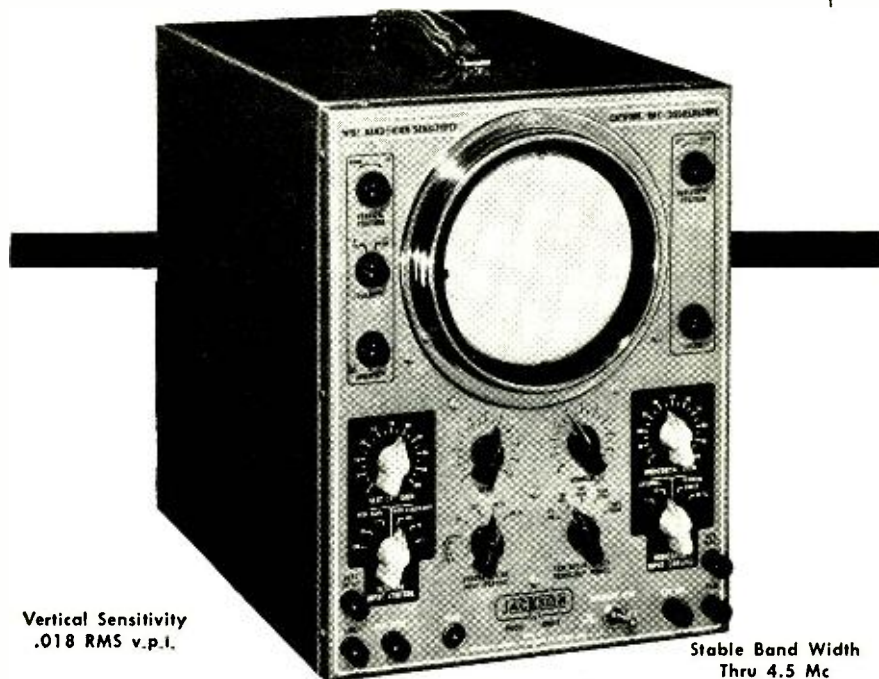

Vertical Sensitivity  
.018 RMS v.p.i.

Stable Band Width  
Thru 4.5 Mc

# JACKSON Oscilloscope gives you "dual service"

This is a high-quality, laboratory-grade 5" Oscilloscope that provides the "dual service" of both high sensitivity and wide band width.

## s p e c i f i c a t i o n s

**Vertical Amplifier**—Video-type frequency compensation provides flat response within 1.5 db from 20 cycles thru 4.5 Mc, dropping smoothly to a still useful value at 6 Mc.

**Sensitivity Ranges**—With a band width of 20 cycles thru 100 Kc, the sensitivity ranges are .018, .18, 1.8 RMS volts-per-inch. The wide band position 20 cycles thru 4.5 Mc has sensitivity ranges of .25, 2.5, 25 RMS volts-per-inch.

**Horizontal Amplifier**—Push-pull with sensitivity of .55 RMS volts-per-inch.

**Input Impedances**—Vertical: 1.5 megohms shunted by 20 mmfd. Direct to plates, balanced 6 megohms shunted by 11 mmfd. Horizontal: 1.1 megohms.

**Linear Sweep Oscillator**—Saw tooth wave, 20 cycles to 50 Kc in 5 steps. 60 cycle sine wave also available, as well as provision for using external sweep.

**Input Voltage Calibration**—Provides a standard voltage against which to measure

voltages of signal applied to vertical input.

**Vertical Polarity Reversal**—For reversing polarity of voltage being checked or for choosing either positive or negative sync. voltages.

**Return Trace Blanking**—Electronic blanking provides clear, sharp trace to prevent confusion in waveform analysis.

**Synchronizing Input Control**—To choose among INTERNAL, EXTERNAL, 60 CYCLE, or 120 CYCLE positions.

**Intensity Modulation**—60 cycle internal or provision for external voltage for intensity modulation uses.

**Additional Features**—Removable calibration screen—Accessory Model CR-P Demodulation Probe for Signal Tracing—All-steel, gray Ham-R-Tex cabinet. Total net weight only 26 pounds. Same height as other Jackson TV instruments: 13" H x 10 1/4" W x 15 1/8" D.

**Prices:** Model CRO-2, Users' Net \$197.50. Model CR-P Probe, Users' Net \$9.95.

### TWO OTHER FINE JACKSON INSTRUMENTS

#### Model 655 Audio Oscillator



Sine-wave 20 cycles to 200,000 cycles. Less than 5% harmonic distortion between 30 cycles and 15,000 cycles. Frequency calibration accurate within 3% or 1 cycle. Hum level down more than 80 db of maximum power output. Output impedances of 10, 250, 500, 5000 ohms or Hi Z resistive output.

#### Model TVG-2 TV Generator



Sweep Oscillator in three ranges from 2 Mc thru 216 Mc, all on fundamentals. Reversible sweep direction. Sweep width variable .1 Mc thru 18 Mc. Marker covers 4 Mc thru 216 Mc. Crystal Oscillator to use as Marker or Galibrator. Video Modulation, from external source for using actual video signal for check, or for use with Audio Oscillator to produce bars for linearity checks.

See your electronics distributor for more information, or write

**JACKSON ELECTRICAL INSTRUMENT CO. • DAYTON 2, OHIO**  
"Service Engineered" Test Equipment  
IN CANADA: THE CANADIAN MARCONI CO.

# 10-METER WALKIE TALKIE

By MELVIN H. DUNBRACK, WIBHD

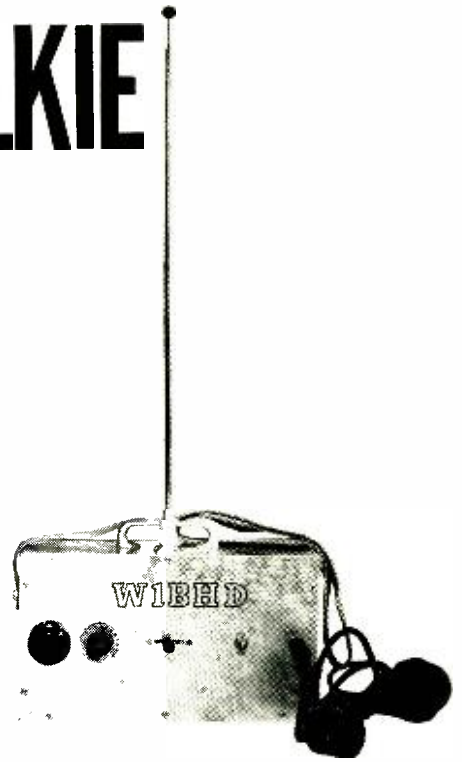
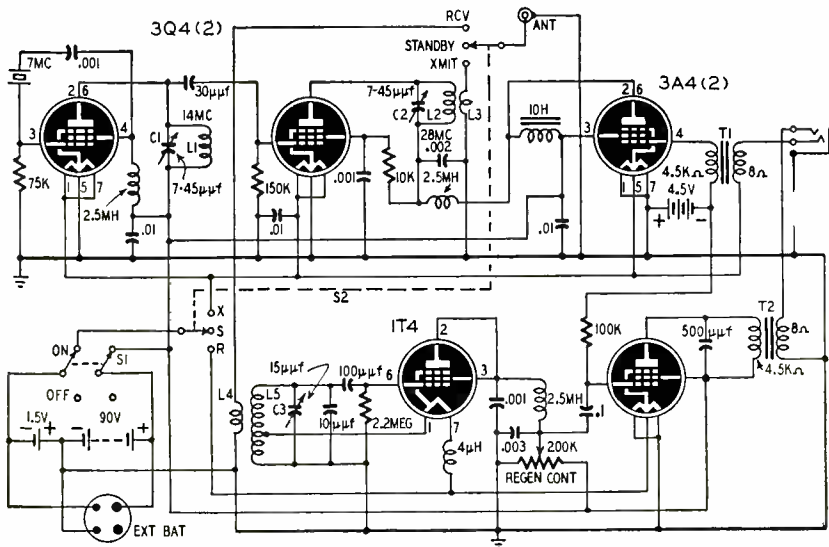

Front view of the 10-meter walkie-talkie transmitter and receiver. Antenna and handset are shown in operating position.

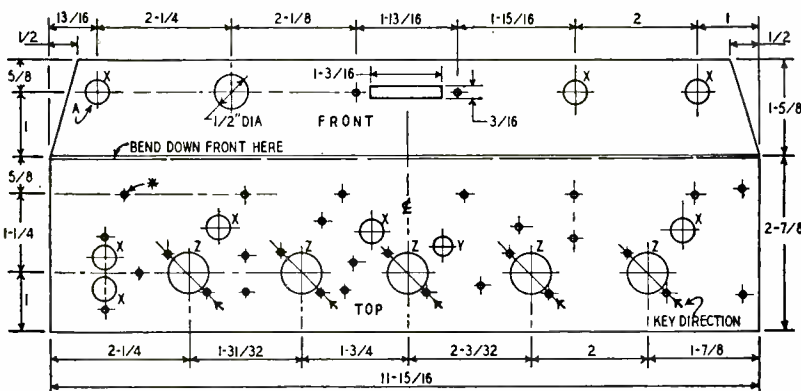

DIMENSIONS IN INCHES X=3/8 DIA Y=1/4 DIA Z=5/8 DIA \*(31) N° 25 DRILL ε= CENTER LINE HOLE A TO LINE UP WITH HOLE ON CASE MARKED A (4)

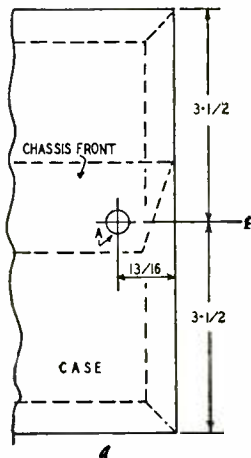

Fig. 1 (top)—Schematic of transmitter and receiver. Crystal-controlled oscillator-doubler is followed by amplifier-doubler with one-stage modulator. Receiver uses a highly efficient, low-radiation superregenerative circuit.

Fig. 2-a—Drawing of right-front edge of front panel. Dashed lines show position of chassis and lip of cabinet. Hole in front panel marked A corresponds to similar hole drilled in skirt of chassis. Fig. 2-b—Layout diagram for cutting, drilling, and bending the chassis.

THIS 10-meter walkie-talkie is one of the most valuable pieces of equipment which we have for civil defense drills and regular ham QSO's. Operating on 28,560 kc from a 7,390-kc crystal we have worked in the Everett Emergency Net and have had many successful contacts with good reports. Its compactness and light weight (7¾ pounds less handset) make the unit ideal for use in locations inaccessible to mobile or larger portable installations. It is unbeatable for liaison to mobiles and fixed stations and as an intercom between rooms in net-control headquarters.

The construction of the unit is shown in the photographs and diagrams. The circuits of transmitter and receiver are shown in Fig. 1. All parts are standard and readily available. Measuring only 12 x 7 x 3 inches, the 5-tube walkie-talkie operates from self-contained batteries and works with a modified whip-type automobile antenna.

### Transmitter section

The transmitter starts out with a 3Q4 with the control and screen grids operating as a triode Pierce crystal oscillator. The plate section of this tube operates as a 20-meter doubler.

The output stage is a 3Q4 doubling to 10 meters. We decided to operate the final as a modulated doubler after tests showed that operating the final straight through meant adding another tube as a doubler-amplifier, increased weight, added battery drain, and neutralizing problems. This stage performs very satisfactorily as a Heising-modulated doubler.



# AMAZING *NEW* IMPREGNANT

***makes good capacitors better  
by permitting higher  
operating voltages***

E-therm impregnated capacitors are now available in production quantities. E-therm is a unique new impregnating material developed and compounded by Sangamo. E-therm impregnated capacitors far exceed the requirements of JAN Specifications. E-therm possesses exceptionally high thermal stability and superior electrical characteristics. E-therm impregnated capacitors mean—higher operating temperatures—lower power factor—higher resistance—longer life.

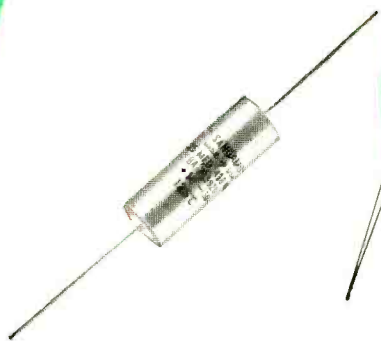
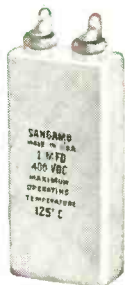

# Etherm

**DEVELOPED BY SANGAMO**  
**Operating temperature 125°C**

E-therm is another example of advanced Sangamo engineering. Continued research and development of new products enables Sangamo to meet the

existing and future needs of the electronic industry. For additional information about E-therm, write for Engineering Bulletin No. 104D.

*Those who know*



*...choose Sangamo*

**SANGAMO ELECTRIC COMPANY**

MARION, ILLINOIS

**BATTERY ELIMINATORS**

**put THOUSANDS of IDLE RADIOS BACK to WORK**

Convert Battery Radios to All-Electric



Model "S" with Selenium Rectifier

Make those battery operated portables "sing" again. No need for high battery replacement costs to shut them up when it's so economical to convert them to permanent AC all-electric operation with an EPL Battery Eliminator. Gives years of hum-free reception. Uses less than 1/4 the power of the cheapest AC radio.

**Simple as A B C**

- A—Slips into battery space.
- B—Insert battery plug or plugs.
- C—Plug into AC outlet.

- Filtering eliminates hum.
- Operates any 1.4 volt 4 to 6 tube radio from 115 volt, 50/60 cycle outlet.
- Guaranteed 3 years.

Patent 2,599,748

Model "BJ"

**MAKE MONEY Testing and Servicing Auto Radios**

**Low Cost Filtered DC Power Supply**

EPL conduction cooling doubles rectifier power rating, gives lowest cost per ampere output and dissipates over 3 times the heat. Withstands high overloads. 1-12.5 amps. 6 volts continuous output, instantaneous rating of 25 amps.

See Your Distributor! Request Folder

**ELECTRO PRODUCTS LABORATORIES**  
 4501-Rs North Ravenswood Ave., Chicago 40, Illinois  
 In Canada: ATLAS RADIO CORP. LTD.  
 Toronto, Ontario

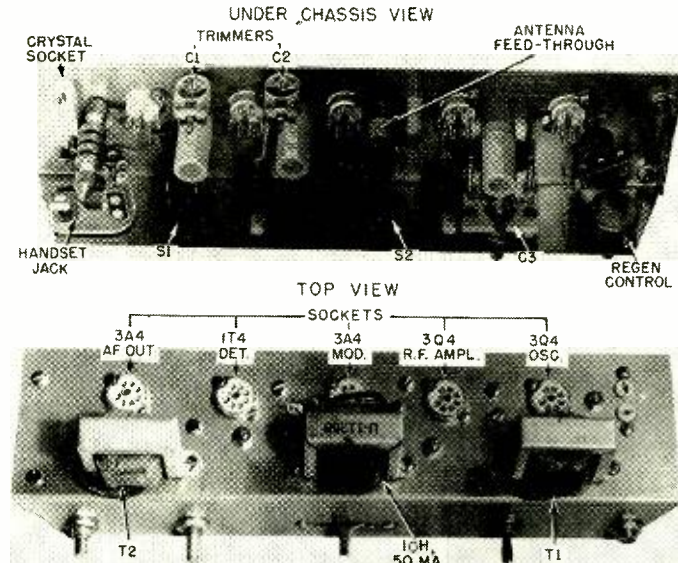

Photo A—Two views of unwired and unmounted chassis. All parts are placed for short leads and easy wiring. Midget components increase the portability.

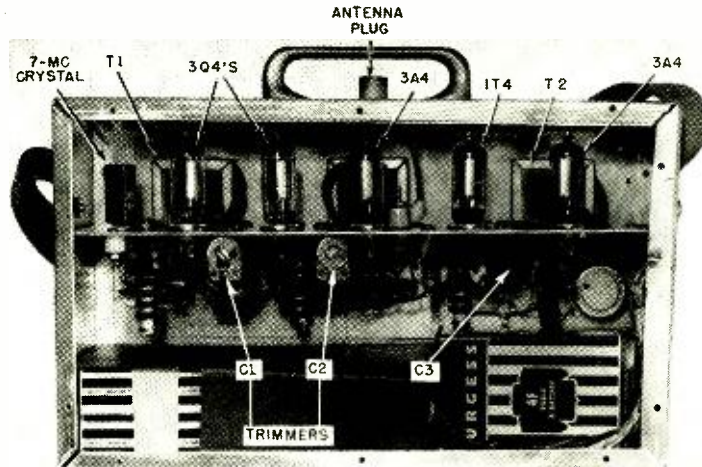

Photo B—Close-up view of the rear of the completed transmitter-receiver. Cabled leads run from chassis to the batteries mounted in the bottom of case.

The modulator is a 3A4 class-A amplifier driven by a carbon microphone in a standard telephone handset. The modulation inductance is a midget 10-henry, 50-ma filter choke. Audio input transformer T1 is a midget output transformer designed to match a 4,500-ohm plate to an 8-ohm voice coil. We selected it after experiments proved that it worked as well as more expensive mike-to-grid transformers. Excitation voltage for the microphone is taken from the transmitter filament line. Like the transmitter filaments, it does not draw current when the control switch is in the RECEIVE or STAND-BY positions.

The 20-meter tank coil L1 consists of 15 turns of No. 20 wire on a 1/2-inch ceramic form. The final tank L2 has 9 turns of No. 20 wire on a 1/2-inch ceramic form like that used for T1. The output link L3 is a 2-turn coil of No. 20 insulated wire wound over the cold end of L2. Turns on all coils are spaced one wire diameter.

**Receiver circuit**

The receiver consists of a 1T4 superregenerative detector and a 3A4 audio

output stage. A 1T4 was chosen as the detector because of its low battery drain and its ability to superregenerate readily. Radiation from this detector circuit is much lower than from ultraudion and other more common superregenerative detectors. When operated with the regeneration controls backed way down, three or more of these units can be netted in the same building without mutual interference. However, it is possible to pick up radiation from the detectors on a good superhet within about 100 feet.

You should not have any trouble getting the detector to operate satisfactorily as a superregenerator. However, if you do run into trouble, a slight change in the value of the grid leak resistor or the grid capacitor should correct it. Superregeneration is controlled by the 200,000-ohm potentiometer which supplies B plus voltage to the plate and screen.

The 3A4 audio stage is conventional and supplies plenty of power to a low-impedance receiver in the handset. Signals can be heard with good volume while holding the handset at arm's length. A volume control is not needed.



# BUILD 15 RADIOS WITH THE PROGRESSIVE RADIO "EDU-KIT"

This is a practical home radio course! No radio experience is needed. You start learning a simple radio circuit and advance as quickly as you wish. You build RECEIVERS, TRANSMITTERS, AMPLIFIERS, CODE OSCILLATOR, SIGNAL TRACER. All parts and instructions are included and clearly explained.

### ALL PARTS ARE INCLUDED!

The Progressive Radio "Edu-Kit" contains all parts necessary to build 15 different radios including tubes, paper condensers, mica condensers, electrolytic condensers, variable condensers, selenium rectifiers, chassis, hardware, tie strips, tube sockets, solder, wire, soldering iron, tubing, coils, instruction book, radio tester, etc.; in brief, everything you need in a practical radio course. The Progressive Radio "Edu-Kit" requires no instructor. All instructions are included. All parts are individually boxed and identified by name, photograph and diagram. Every step involved in building these sets is carefully explained. You cannot make a mistake.

Nothing extra to buy . . . nothing to return . . . you keep everything! You can quickly pay for kit by repairing radios. Think of it — the signal tracer alone is worth more than the small cost of this kit!

### WHAT "EDU-KIT" BUYERS SAY!

"I can assure you that it is a wonderful kit and good value" C. J. Benadie, Newton Road, Beaconfield, Kimberley, South Africa: "I am very satisfied with the "Edu-Kit" Dominic Stracuzza, 111 Clarence St., London, Ont. Canada: "I received my Progressive "Edu-Kit" and I want to let you know that I am very pleased with it" F. B. Hartman, 290 Westminster St., Providence, R. I.: "This morning I was showing my Progressive Radio "Edu-Kit" to one of our representatives from our office in Richmond, and, already he wants me to purchase some for his hospitals" Veterans Administration, Physical Medicine Rehabilitation Service, Washington, D. C.: "I received one of your Radio "Edu-Kits" and I am happy to report that my ten-year-old boy, with very little supervision, built a complete three-tube receiver - one that works - in less than three hours" Bill Leonard, C.B.S. Radio, New York, N. Y.

STUDY FOR  
A GOOD PAYING  
NEW JOB!



ENJOY AN  
INTERESTING  
HOBBY!



START YOUR OWN  
PROFITABLE  
BUSINESS!



**FREE RADIO TESTER . T. V. BOOK  
FREE QUIZZES . SOLDERING IRON  
MEMBERSHIP IN RADIO AND T. V. CLUB**

FREE Radio and T.V. Trouble-shooting Guide sent when you ask for complete information OR rush us your order and you get FREE valuable Surprise Gift Package in addition to Radio and T.V. Trouble-shooting Guide. Write today!



*Now anyone can*

# LEARN RADIO

*at Home*



**NO PREVIOUS  
TRAINING  
NEEDED... EXCELLENT  
BACKGROUND FOR T.V.**

Specifically prepared for any person with the desire to learn radio, it has been successfully used by young and old. It is unnecessary to have even the slightest background in science or radio. The Progressive Radio "Edu-Kit" is used by many Radio Schools & Clubs in this country and abroad. It is used by the Veterans Administration for Vocational Guidance and Training.

*You risk nothing -*  
**10 DAY MONEY-BACK GUARANTEE**

**BUILD 15 RADIOS**  
*Only*  
**\$19.95**  
**COMPLETE**

**PROGRESSIVE ELECTRONICS CO.**  
497 UNION AVE. RE-64 BROOKLYN 11, NEW YORK

POSTAGE PREPAID  
- E.O. ORDERS ACCERTED IN MASS.



## The SMART, NEW way to buy your C-D Seal-Vent Vibrators in the RE-USABLE Plastic Vibrator Kit

You get the re-usable plastic box FREE with the nine vibrators

You get the best vibrators money can buy

You get in one purchase the 5 types that serve over 60% of the popular replacement requirements

Save time . . . with the convenient C-D VIBRATOR KIT that gives you 9 vibrators in 5 types PLUS a sturdy transparent plastic box with a hinged cover and dividers that has dozens of uses around the shop and at home. The assortment includes two 5300; two 5301; two 5326; two 5342 and one 5335 — all with the remarkable SEAL VENT that allows the vibrator to remain sealed until used and then vents itself automatically for "breathing" when put into use for even greater performance.

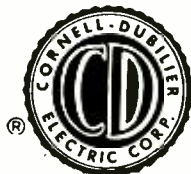

CONSISTENTLY DEPENDABLE

**CORNELL-DUBILIER**  
SOUTH PLAINFIELD, NEW JERSEY



• ROTORS • CAPACITORS • ANTENNAS • CONVERTERS  
• VIBRATORS

# WANTED

**WE NEED YOUR SURPLUS  
ELECTRONIC EQUIPMENT**

**WE PAY TOP \$\$\$ FOR:**

- ★ RADIO RECEIVERS
- ★ TRANSMITTERS
- ★ ARC-1
- ★ ARC-3
- ★ ART-13
- ★ CONTROL BOXES
- ★ INDICATORS
- ★ CLAMPS
- ★ PLUGS
- ★ CORDS
- ★ RELAYS
- ★ TELEPHONE MATERIALS
- ★ AN CONNECTORS
- ★ WE BUY ANYTHING!

Write, Wire today! Tell us what you have.

TALLEN CO., Inc., Dept. RE  
159 Carlton Ave., Brooklyn 5, N. Y.

## EASY TO LEARN CODE

It is easy to learn or increase speed with an Instructograph Code Teacher. Affords the quickest and most practical method yet developed. For beginners or advanced students. Available tapes for beginner's alphabet to typical messages on all subjects. Speed range 5 to 40 WPM. Always ready—no QRM.

**ENDORSED BY THOUSANDS!**

The Instructograph Code Teacher literally takes the place of an operator-instructor and enables anyone to learn and master code without further assistance. Thousands of successful operators have "acquired the code" with the Instructograph System. Write today for convenient rental and purchase plans.



**INSTRUCTOGRAPH COMPANY**

4701 Sheridan Rd., Dept. RC, Chicago 40, Ill.

Output transformer T2 matches a 4,500-ohm plate to an 8-ohm load. A 4.5-volt C battery supplies bias for the 3A4's in the audio output and modulator stages.

Receiver tuning is conventional and very simple when you get the hang of it. To minimize radiation from the receiver, be sure to keep the regeneration control backed down to the minimum setting which provides satisfactory reception. Failure to observe this precaution will cause the receiver to radiate a signal which may interfere with reception on nearby receivers tuned to the same frequency.

The receiver grid coil L5 consists of 9 turns of No. 20 wire spaced one diameter on a 1/2-inch form. The cathode tap is placed 2 1/2 turns up from the ground end. L4 is a 2-turn link of No. 20 insulated wire wound over the bottom end of L5. The 4-μh filament choke consists of 40 turns of No. 28 enameled wire close-wound on a 1/4-inch form.

A 2-pole, 3-position lever switch S2 (Mallory 6143 or equivalent) selects the RECEIVE, STAND-BY, and TRANSMIT functions. One section switches the 1.5-volt battery between the filament lines of the receiver and transmitter and keeps the circuit open when in the STAND-BY position. The second section of S2 switches the antenna from the transmitter to receiver. Toggle switch S1 is the battery switch. It should be placed in the OFF position when you are through using the unit. If you don't, the drain through the 200,000-ohm regeneration control will soon exhaust the B battery.

### Construction

The cabinet of the walkie-talkie is a 12 x 7 x 3-inch aluminum removable-top chassis with bottom cover plate. The chassis is a strip of 3/32-inch aluminum approximately 12 x 1 1/2 inches, bent and drilled as shown at *b* in Fig. 2. The holes and slot in the front lip of the chassis line up with similar openings cut into the front panel. The chassis and panel are held together by the controls fastened to them. Fig. 2-a shows position of chassis in cabinet. Top of chassis is 1 inch above chassis center line. The front-view photo shows the operating controls and the handset plugged into a 3-circuit jack. From left to right, the controls are: TUNING, REGENERATION, SEND-RECEIVE switch, and BATTERY switch.

Photo A shows two views of the chassis before it is wired and mounted on the panel. The top part of the photo shows the under side with the major parts mounted but unwired. The lower part of the photo shows the top-front view of the chassis. Photo B is a close-up of the rear of the unit after it is completed. The rear cover has been removed to show the inside of the finished project. Two 3/8-inch holes are drilled in the rear cover plate over the two trimmer capacitors so the transmitter can be tuned with the cover in place. Two 3/8-inch plug-buttons seal the holes against dust.

Two Burgess XX30 or equivalent 45-volt batteries connected in series are



FROM  MANUFACTURER...

TO  JOBBER... TO 

SERVICEMAN TO  CONSUMER



## ASTRON CAPACITORS

MEAN A \_\_\_\_\_ LONG LINE

OF RELIABILITY & SATISFACTION.

You can depend on ASTRON Capacitors! They've earned a reputation for outstanding performance and reliability—a reputation that means something to YOU. When you replace with ASTRON, you build your reputation for high-quality service. Every step of the way, ASTRON means reliability... reliability that pays off in more satisfied customers, less call-backs, better earnings for you. Talk to your jobber about ASTRON Capacitors today, or write us for the name of the Astron Distributor nearest you.

DEPEND ON...  
INSIST ON



# ASTRON

255 Grant Avenue East Newark, N.J.

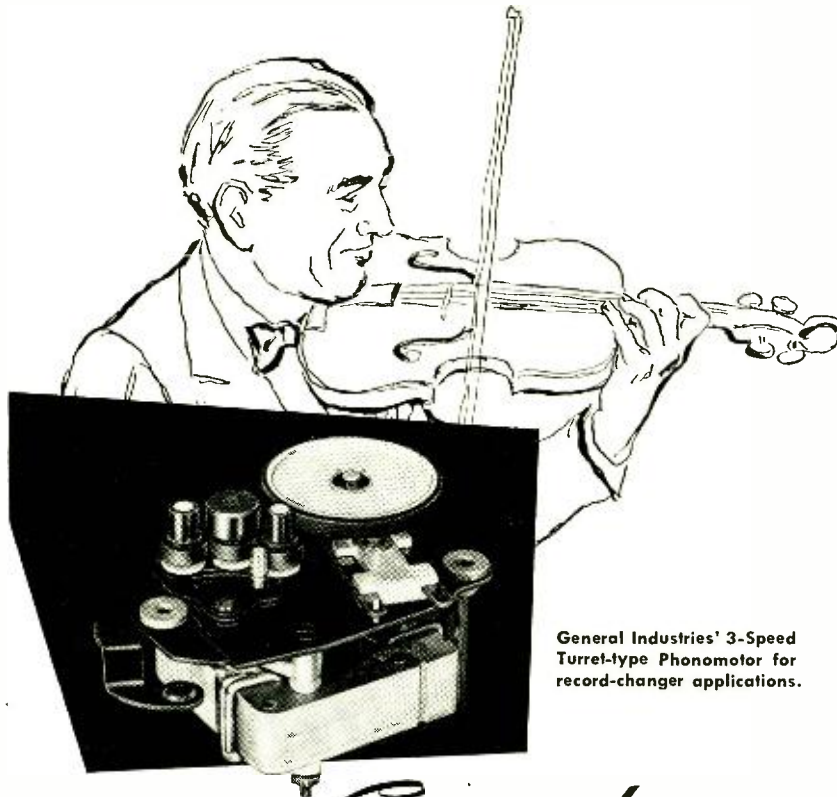

General Industries' 3-Speed Turret-type Phonomotor for record-changer applications.

*Smoothness...*

another reason why leading manufacturers prefer General Industries' 3-Speed Phonomotors

Complementing the rich, unwavering tones of a recorded masterpiece, is the uniformly smooth, quiet operation of the General Industries *Smooth Power* Phonomotor. Unique drive mechanism assures accurate turntable speed at 33 $\frac{1}{3}$ , 45 and 78 R.P.M.

Write *today* for detailed information about General Industries' *complete* line of phonomotors for every phonograph application.

**THE GENERAL INDUSTRIES CO.**

Department ME • Elyria, Ohio



installed in the lower left-hand corner of the cabinet, and a Burgess 4F or similar 1.5-volt battery is mounted in the right-hand corner. Three No. 1 flashlight cells are connected in series for the bias battery. These are mounted in a plastic soap case with two small holes drilled for leads to the battery cable. The bias battery is in the center between the A and B batteries.

The shoulder strap is made from a 36-inch length of 1-inch belt webbing. It is attached to the sides of the case by 1/4-inch bolts with 2-inch washers under the heads to ease the strain on the webbing.

The plug-in antenna is made by inserting a long 6-32 screw into the bottom end of a telescopic automobile antenna and sweating it into place. The exposed threads are then filed off so the Amphenol 83-1SP plug can be pushed on and soldered in place. A piece of insulating tubing is slid down over the antenna into the plug to keep the antenna from shorting to its shell. Our whip extends to a full 6 feet but we find that about 5 feet gives good all-around results. Local contacts can be made with the antenna collapsed to 2 feet.

The socket for external batteries, shown in Fig. 1 but not the photos, was added so the set can be used with a battery eliminator or heavy-duty batteries too large for the case.

The transmitter is easy to tune up. The first doubler is tuned roughly to 14 mc and the second doubler to about 28 mc. Then a field-strength meter or a communications receiver with S-meter is used to set both trimmers for maximum output. When operating, the final amplifier delivers approximately 1/2 watt into the antenna.

**Materials for walkie-talkie**

- Resistors:** 1—10,000, 1—75,000, 1—100,000, 1—150,000 ohms, 1/2 watt; 1—200,000-ohm potentiometer; 1—2.2 megohms, 1/2 watt.  
**Capacitors:** (Ceramic) 1—10  $\mu$ uf. (Mica) 1—30, 1—100, 1—500  $\mu$ uf; 3—.001, 1—.002, 1—.003, 3—.01  $\mu$ f. (Mica or paper) 1—0.1  $\mu$ f, 400 volts or more. (Variable) 1—15  $\mu$ uf. Millen 20015 or equivalent, 2—7.45  $\mu$ uf ceramic trimmers, Centralab TS2A.  
**Miscellaneous:** 3—2.5-mh r.f. chokes; 1—10-henry, 50-ma midget filter choke; 5—7-pin miniature sockets; 1—Coax plug, Amphenol 83-1SP; 1—coax receptacle, Amphenol 83-1R; 1—crystal socket, Millen 33102 or equivalent; 1—d.p.s.t. toggle switch; 1—2-circuit, 3-position lever switch, Mallory 6143 or equivalent; 1—3-circuit jack; 2—midget a.f. output transformers, 4,500 ohms to 8 ohms; 1—telephone handset, low-impedance carbon microphone and low-impedance receiver; 1—IT4, 2—3A4, 2—3Q4, batteries, crystal, chassis, antenna hardware, coil forms. EN1

**PRES-PROBE CONDENSER TESTER**



**Finds Intermittent Condensers Instantly**

Pres-probe's sliding tip with variable resistance prevents condenser heating. Tests with power on. Requires no adjustment. Stops guesswork. Saves time. Convenient probe size (7 1/4" long). Satisfaction guaranteed.



See Your Dist. or Order Direct  
**PRES-PROBE CO.**  
 4034 N. Sixth St., Milwaukee 12, Wisc.

**New Proximity Probe**

**TESTS ALL TV HI VOLTAGE SUPPLY SYSTEMS**

INSTANTLY checks hi-voltage transformer action-horizontal oscillator-sweep output-damper-hi-voltage rectifier, etc. Used under actual operating conditions. Determines exact procedure to trouble shoot no raster problems and intermittents. No connections—no shocks—saves time-clips in pocket. Used by professional TV servicemen for home calls and bench work. Complete instructions enclosed.

Send check or M.O. Postpaid U.S.A. Net **\$3.95** Fully Guaranteed  
**SERVICE PRODUCTS CO.**  
 Box 215 Lawrence, Mass.





**CODE SENDING RECEIVING SPEED**

Be a "key" man. Learn how to send and receive messages in code by telegraph and radio. Commerce needs thousands of men for jobs. Good pay, adventure, interesting work. Learn at home quickly through famous Candler System. Qualify for Amateur or Commercial License. Write for FREE BOOK.

**CANDLER SYSTEM CO.**  
Dept. 3-L, Box 92R, Denver 1, Colo., U.S.A.

**FREE**

Write today for "How to Service T.V. Receivers" with the HICKOK VIDEO GENERATOR.

**Hickok Electrical Instrument Co.**  
10814 Dupont Ave., Cleveland, Ohio

**ON-THE SPOT BATTERY RECORDER**

**WALKIE-RECORDALL** 8 lb. miniature BATTERY RECORDER-PLAYBACK

Continuous, permanent, accurate, indexed recording at only 3c per hr. Instantaneous, permanent playback. Picks up sound up to 60 ft. Records conferences, lectures, dictation, 2-way phone & sales talks; while walking, riding or flying. Records in closed briefcase with "hidden mike"! Write for details.

**MILES REPRODUCER CO., INC.**  
812 BROADWAY Dept. RE-10 NEW YORK 3, N. Y.

**PEN-OSCIL-LITE**

Extremely convenient test oscillator for all radio servicing; alignment • Small as a pen • Self powered • Range from 700 cycles audio to over 600 megacycles u.h.f. • Output from zero to 125 v. • Low in cost • Used by Signal Corps • Write for information.

**GENERAL TEST EQUIPMENT**  
38 Argyle Ave. Buffalo 9, N. Y.

**TEL-A-SCOPE ALUMINUM MAST**

*Something New!*

Meets a definite need in the field of TELEVISION-MICROWAVE-RADAR

Insures clear TV channel reception with minimum interference and a choice of stations.

- Easily installed and serviced by one man. No climbing - no roof damage.
- Built of tempered aluminum. Rustproof.
- Easily raised - as high as 100 feet — HYDRAULICALLY by hand, oil or water pump, or available water pressure.
- Readily adaptable to community television systems. Ideal for trailer camp or motel.

Used by Government Agencies.

WRITE FOR DETAILS.  
**THOMAS MOLD & DIE CO.**  
WOOSTER, OHIO



**FASTER STURDIER**  
Lower Installed Cost

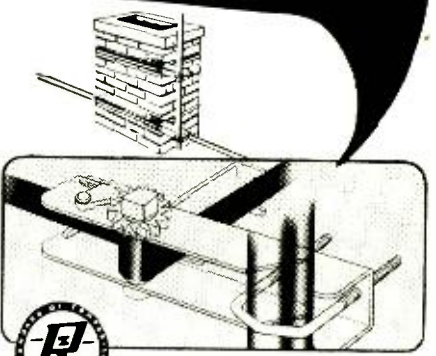

**RADIART SPEE-DEE CHIMNEY MOUNT**

**Model AK 85** The fastest-installed chimney mount ever devised for TV antennas! Rugged in design—simple to install. Simply thread strapping through ratchet, around chimney and back through ratchet—wind up ratchet tight—and the job's done! Heavy gauge, zinc-plated steel with large "U" bolt for up to 1 1/4" O.D. mast and full length galvanized steel strapping.

**THE RADIART CORPORATION**  
CLEVELAND 13, OHIO

**NEW TV COURSE**

**"TV Studio Operations"**

**CREI Announces:** a new non-mathematical, non-technical course which can get you in on the ground floor of the mushrooming TV field.



**26th YEAR**

**Mail Coupon Today For Full Details**

Capitol Radio Engineering Institute  
Dept. 5010, 3224 Sixteenth St., N.W.  
Washington 10, D. C.

Please send me further information regarding your new TV Studio Operations course. No obligation.

Name.....  
Address.....  
City.....Zone.....State.....

More than 2,000 new TV stations will be built now that the FCC freeze is off—yet even today there aren't enough trained studio personnel for TV stations already in operation. There is a good job waiting for you—if you have the "know how" which you can get from this new Home Study Course, prepared by Capitol Radio Engineering Institute with the cooperation of all 4 major television networks. This cooperation assures you that you will learn what the TV industry wants you to know.

You study and learn how the top professionals do it—in your own home—you will work very closely with CREI, whose expert instructors will guide you in a personal way. When you graduate, you will have a CREI certificate as your "passport" into the TV station industry.

Send today for a brochure that tells you all you want to know about this helpful new short course. The sooner you learn—the sooner you will earn.

# 10-DAY TRIAL

OF THE BEST-PERFORMING  
LOW-PRICED, ALL CHANNEL  
ANTENNA ON THE MARKET!

THE FRINGE AREA

**B**utterfly  
TRADE-MARK

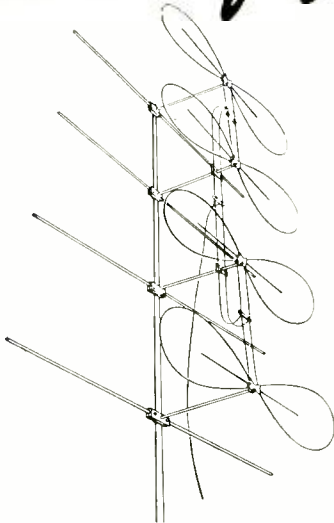

You can enjoy perfect long-range television reception for 10 days with a Fringe Area Butterfly — and it won't cost you a cent for its use.

To acquaint you with this outstanding new all-channel antenna, Tel-a-Ray will send you a Fringe Area Butterfly you can use for 10 days.

If you want to keep the Butterfly after 10 days, you may do so at a price of only \$29.95 (list price) for the four-bay array shown above. If not, send it right back.

Your only cost for using this matchless, long-range, all-channel antenna for 10 days is the shipping charge.

Give your family or customer TV reception at its best. Try a Butterfly! It's a Tel-a-Ray exclusive.

**TEL-A-RAY**  
ENTERPRISES, INC.  
HENDERSON, KY.

# DX CRYSTAL RADIO RECEIVER

By JOSEPH AMAROSE

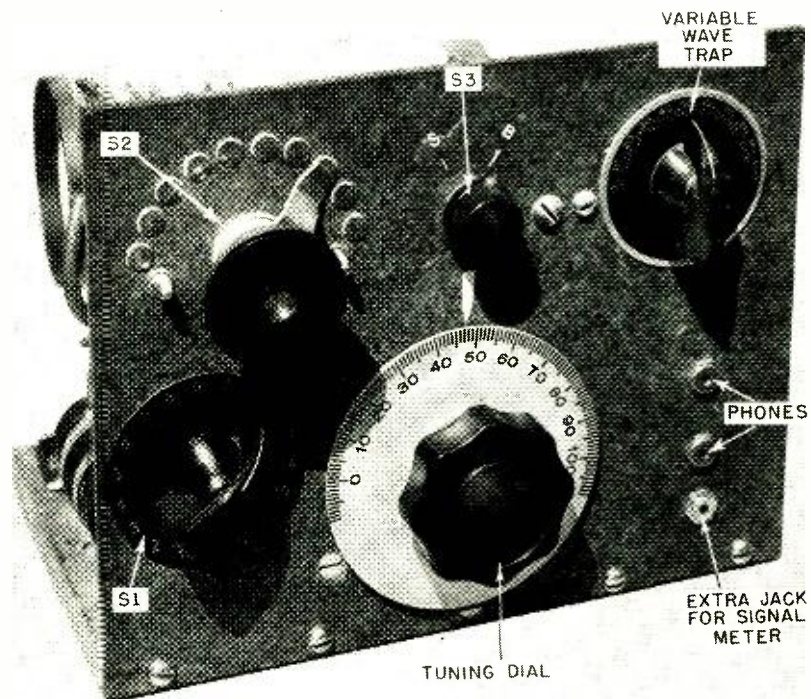
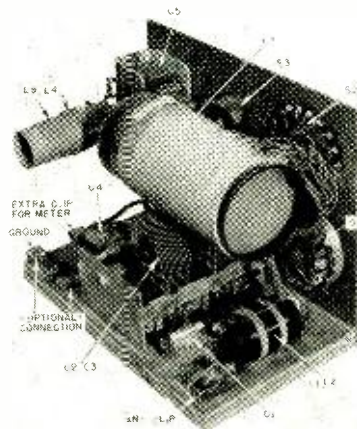

CRYSTAL radio fans follow a pattern. They search everlastingly for a newer, better circuit that will excel their previous best effort. They want better volume, greater selectivity, higher sensitivity. Everlastingly, too, they must compromise, for no such optimum state can be achieved. Occasionally, an experimenter does find a circuit that is outstanding. Such is the hookup shown. No novelty is claimed, however; basically the circuit is old—only a few embellishments have been added. Nor must the reader expect that this receiver combines all the desired characteristics. What the writer (who has spent some 30 years testing and building the latest crystal “super-doopers”) does promise is an unusual, versatile receiver that has consistently given fine results.

All last winter (in Virginia) this receiver tuned in stations from Canada to Cuba and from the Atlantic to the state of Utah, sometimes as early as 8 pm. Transmitters in Atlanta, Louisville, Chicago, Detroit, New York, New

Orleans and Cleveland were most frequently logged. Even on the hottest summer nights, dx came in with impressive regularity.

No less impressive is the selectivity of this rig. All six of the Richmond locals are received clearly with no annoying hash or cross-talk. And three of these stations are only 40 kc apart! Worse still, one is a weak sister between two strong ones. Yet this set gets all with ease. With proper co-ordination of controls all locals (from 910 to 1480 kc) can be tuned in with just the one main tuning dial. Tested in Baltimore by M. M. Schuman, another old-timer (who built this set), the receiver tuned in all eight locals clearly there, plus the more distant WTOP in Washington, D. C.

Volume on the locals is high. Richmond's WRNL, 5,000-watt transmitter, five miles away, operates a magnetic speaker loud enough to be heard clearly 15 feet from the reproducer. It doesn't shake the rafters but every word of speech is intelligible at that distance.

RADIO-ELECTRONICS



How are these results achieved? First and foremost, for good dx, the antenna system should be of the best. A 125-foot aerial was used, 31 feet high, with the lead-in taken from the far end; this proved better than the usual "L" type. Total antenna wire to the set was 260 feet. Shorter aerials are O.K., if high.

The fixed antenna wave trap, L1, L2 and C1, is to be used only when two strong stations interfere. Set C1 so it confines the most troublesome station. For dx work, eliminate this trap entirely! Sensitivity is higher.

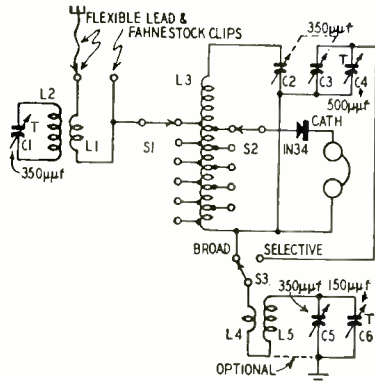

**PARTS LIST**

- C1—350-µf trimmer.
  - C2, C3—2-gang 350-µf variable capacitors.
  - C4—500-µf trimmer.
  - C5—350-µf variable capacitor.
  - C6—150-µf trimmer.
  - S1—17-point switch.
  - S2—10-point switch, or 10 switch points and lever.
  - S3—S.p.d.t. panel switch.
- Other materials needed are coils as given in the table, a crystal, a pair of sensitive phones and the necessary panel, breadboard, hardware, etc.

The main tuning coil, L3, is an MRL (Modern Radio Laboratories, 1131 Valota Drive, Redwood City, Calif.) "low-loss" type. The constructor can make his own by winding 90 turns of No. 22 double-cotton-covered wire on a 2-inch plastic coil form 4 inches long (actual winding is 3 inches). Brush on a layer of very thin coil cement to make it stick to the coil and tap both antenna and secondary sides. Tap the antenna side every three turns from the 3rd to the 51st, and tap the secondary every five turns from the 5th to the 50th. Lift the turns with an ice pick to solder.

A standard 2-gang capacitor is used for C2 and C3, with a 500-µf trimmer across the second section, for hand-spreading on high frequency end. Adjust this trimmer, C4, for best volume on a 1000 kc station.

Switch 1 selects the proper antenna primary-coil tap. Switch 2 is used to match the impedance of the crystal. Tune in all locals, select the setting that gives best selectivity with good volume, and leave set. From ground end switch 3 provides a choice between peak sensitivity and high selectivity.

In the variable trap, L4, L5 and C5, a Carron S-645 coil is used. The primary, secondary and variable capacitor are series hooked. An "optional connection" is shown. If used, it makes a conventional wave trap of the section. Not used, another tunable circuit is provided, acting like a series-tuned loading coil and capacitor. With this arrangement, tuning is better.

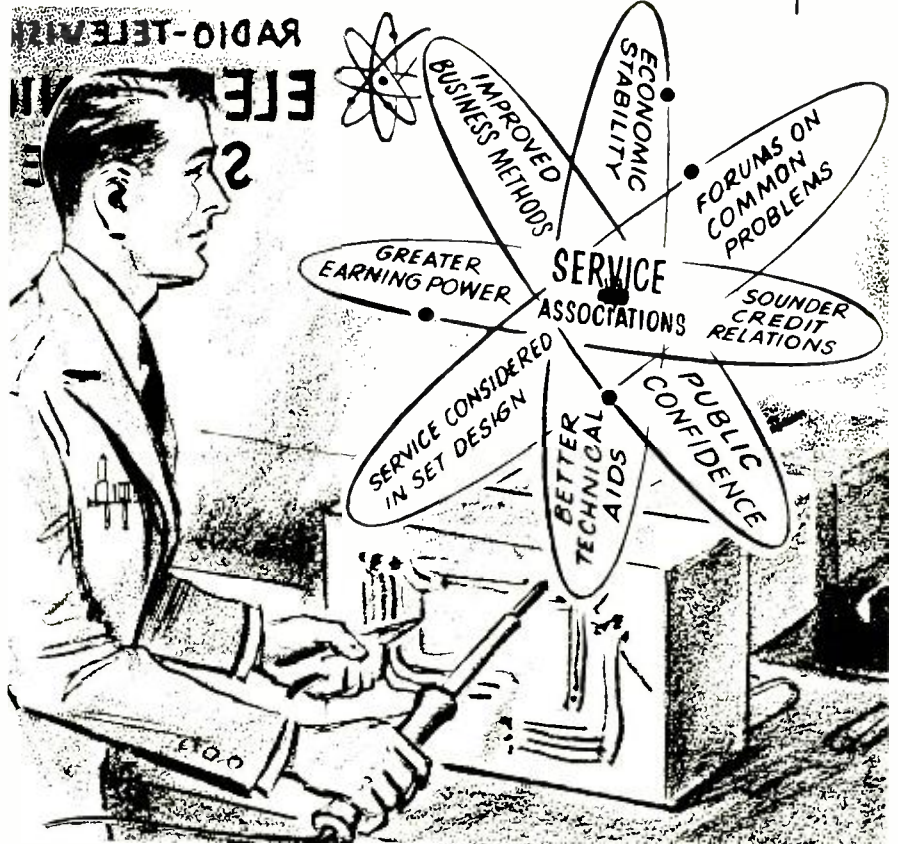

## THE MODERN ELECTRONIC TECHNICIAN HAS A NEW VIEWPOINT!

A changing attitude on the part of the radio and television service technician is the thing that is pulling the electronic service profession out of the doldrums. He is learning that he cannot call himself a success, as an individual, until he can look around and see other technicians who have assets he can admire or compare with his own. As long as there are too many in his profession operating without scruples, and trying to get along under a "hand to mouth" economic operation without adequate testing instruments and other technical aids, there is not much to measure one's success by.

His interest and attendance at the local service association meeting shows that the modern Electronic Technician is beginning to look beyond the "tip of his soldering iron." Through these associations, he is rapidly gaining recognition, not only in his own community, but also in the vast electronic industry, as being an essential link between the manufacturer and consumer.

In addition to getting valuable technical "know-how" from non-commercial sponsored lectures and demonstrations, he is finding out how to make his business bring a fair return on his rather large investment in training, experience,

and testing instruments. He is also learning how to be fair to both his customers and himself by keeping his "know-how" and test equipment up-to-date and not resorting to price cutting for his service in diagnosing trouble.

As technicians gain that feeling of mutual respect and esteem among themselves by regarding each other as business associates instead of raw competition, their most valuable asset—technical "know-how"—will no longer be obscured. The technician's interest in matters which affect his economic welfare will lead him and the entire service industry to greater economic stability.

The time and money you devote to your service organization is not an expense—it is an investment in your future that will be paid back many, many times.

Our 25th Year

# SUPREME

Testing Instruments

\*SUPREME BY COMPARISON\*

TUBE TESTERS • SIGNAL GENERATORS  
PANEL METERS • MULTI-METERS  
OSCILLOSCOPES

Supreme, Inc. Greenwood 2, Mississippi

# PHOTOFACT USERS TELL THE EXPERT WAY TO TACKLE ANY TV-RADIO SERVICE JOB

## here's what you do:

**1**

Determine the make and model number of the set on your bench. Use your PF INDEX to find the applicable PHOTOFACT Folder—takes just 60 seconds.



**2**

Reach into your PHOTOFACT library for the proper Folder. You're ready for time-saving, work-saving, expert service action.



**3**

### YOU HAVE YOUR HANDS ON THE ONE TOOL YOU'LL USE ON EVERY JOB

Here's what you find in PHOTOFACT Folders: A uniform, consistent presentation of *complete* service data, *accurate* because it's based on actual analysis of the production receiver. And here are the exclusive features—Standard Notation Schematics with voltages and wave forms right on the diagrams; chassis view photos, top and bottom, with all parts and relationships shown, all alignment points given, all parts identified; tube placement diagrams, top and bottom, all tubes and functions indicated, even socket pin locations shown, including fuse location guide and rating; tube check chart showing common troubles and tubes responsible; complete alignment instructions, including oscilloscope patterns; resistance measurements taken at every tube socket; separate photos of TV tuner, showing all parts locations and alignment points; photos of cabinet showing service controls; complete disassembly instructions; complete parts lists, each part identified by circuit symbol and keyed to schematics and photos—showing ratings, manufacturer's original part number and proper replacements available from 29 leading components manufacturers—plus—dial cord stringing instructions; special service instructions (such as horizontal sweep circuit adjustments, etc.)—everything you have a right to expect in the world's finest TV-Radio service data . . .

**4**

### NOW HERE'S HOW YOU SAVE TIME AND EARN MORE

You're ready to tackle the job—any job—because you have *all* the answers *instantly* at your finger tips in PHOTOFACT. Here are the *practical* ways it works for you: Suspect a tube? Diagnose and replace the defective tube in seconds—the tube location chart shows you which one and where. Operating voltages correct? The exact answers are right on the schematic—available at a glance. Need fuse replacement? The answer's right on the tube location guide. Defective component? There's the *right* replacement in the parts list. For these and a hundred other problems, PHOTOFACT provides the *instant, correct* solution. That's why the experts use PHOTOFACT—the practical way to *save time and earn more*.

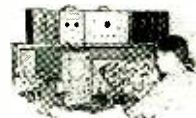

Yes, your PHOTOFACT Service Data is the ONE TOOL YOU'LL USE ON EVERY SERVICE JOB

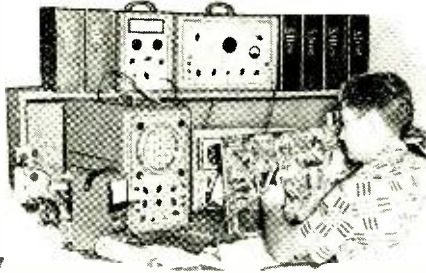

if you're not using the Expert Way—we'll prove you'll save time and earn more with PHOTOFACT service data

**FREE**

**SERVICE TECHNICIANS  
HERE'S OUR OFFER:**

We'll send you any Photofact Folder listed in the "PF INDEX and Technical Digest." If you haven't an Index, get a Free copy from your local Photofact distributor or write us for it today. To obtain Free Folder, be sure to state Photofact Set and Folder Number exactly as shown in the Index.

NOW—learn for yourself how PHOTOFACT makes your TV and Radio repair work *quicker, easier, more profitable*. We want you to get and use an actual PHOTOFACT Folder. We want you to know why over 35,000 expert service technicians count on this invaluable data daily—count on it for *successful, profitable* business. Get your FREE Folder now. Examine, compare. Then try the Expert Way on your very next job. You'll discover why you can't afford to be without PHOTOFACT!

**NOTE: Our FREE Folder offer is limited to Service Technicians only. Attach coupon to your letterhead or business card, and mention your jobber's name. Experimenters and others may obtain the Photofact Folder by remitting amount shown below.**

#### HOWARD W. SAMS & CO., INC.

HOWARD W. SAMS & CO., INC.  
2205 E. 46th St., Indianapolis 5, Ind.

I am a Service Technician. Send me Free Folder No. . . . . which appears in Photofact Set No. . . . . (as listed in the PF Index).

I am an Experimenter. Enclosed \$ . . . . . Send Folder No. . . . . which appears in Photofact Set No. . . . . (TV—\$1.00. AM/FM—50c. Record Changer or Communications Receiver—75c).

Name . . . . .

Address . . . . .

City . . . . . Zone . . . . . State . . . . .

**EASY  
PAY  
PLAN!**

**PAY AS YOU EARN!** Ask your distributor about this desirable plan. Only \$18.39 puts the entire profit-boosting Photofact library in your shop now!

The ground for this set was the pipe in a well. This makes the best possible ground connection; a signal meter showed almost twice as much signal strength as with other grounds. The urban dweller should use *cold water* pipes, with the wire attached close to the earth. Additional grounds also boost signal strength and are recommended.

### Operating the set

The settings obviously will differ in each locality, depending upon the frequencies employed by the local transmitters. Individual experiment is necessary to determine optimum settings of controls. Generally, for dx work, eliminate the antenna wave trap, throw S3 to the BROAD position, and do not make the "optional connection." For best selectivity, use the antenna wave trap, move S3 to the SELECTIVE position, and hook up the OPTIONAL CONNECTION. With the connection closed, tune the trimmer C6 to loudest volume on a 1000-ke station. This completes all adjustments on this set.

In constructing the receiver, it is important to position both wave-trap coils as far as possible from the main tuning coil. The selectivity will be poor if their magnetic fields are allowed to affect each other.

A word about "signal meters." The serious dx fan will do well to consider using a sensitive microammeter across the phone posts, to determine peak signal strength. All the unusual results achieved by this receiver are due to the use of such a meter. Many months were spent making changes until the present circuit arrangement was arrived at; more time was spent in determining the best aerial and ground arrangements. All the optimum conditions were quickly revealed by the meter readings. By the cut-and-try aural method usually used, optimum conditions could not be very readily determined. These meters are still available at prices under \$10 in surplus houses. A 200-microampere instrument is ideal. Especially useful is this device in picking out the most sensitive detector; some crystals give twice as much output as others, and a meter can spot your best one in an instant. For weak stations and dx work, this is most important. The value of such an instrument in helping to get distance cannot be overemphasized.

Finally, super-efficient as the aforementioned receiver might be, no extravagant claim is made for it. All the writer can say is, that, of the large crop of radios tested through the years, this one stands head and shoulders above the crowd. Made according to specifications, it should provide the hobbyist with no end of pleasure and entertainment.

#### COIL TABLE

L1—25 turns No. 30 enameled wire wound over L2.  
L2—125 turns No. 30 enameled wire on 1-inch form.  
(A low-impedance antenna coil will work well here. The constructor used a Carron S-645.)  
L3—90 turns double-cotton-covered wire close-wound on 2-inch coil form.  
L4—Low impedance primary of Carron S-645 broadcast antenna coil.  
L5—Secondary of same coil. \* END



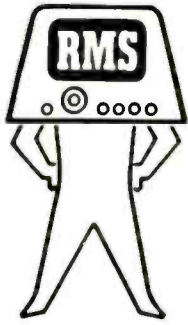

A properly selected **RMS** antenna helps you do...

# THE BEST JOB IN YOUR AREA

## HOW TO SELECT THE PROPER RMS ANTENNA FOR YOUR PARTICULAR INSTALLATION

• up to 25 miles — FA-1 OR VA-100

• up to 60 miles — FA-2, CVA-500, STY (5 element yagi)

• up to 85 miles — FA-4, CVA2-500

• over 85 miles — CVA4-500, STYL8—, STYL10—

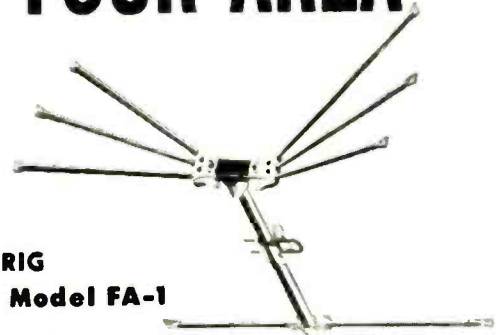

**REDI-RIG**  
**RMS Model FA-1**

- Completely preassembled — no loose parts or hardware.
- Exceptionally flat response across entire tv band.
- 3/8" dowel-reinforced aluminum elements.
- Plus six other distinctive mechanical and structural advantages!

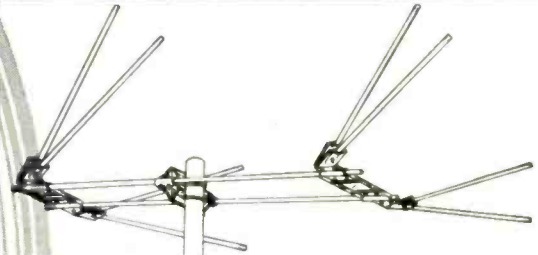

**FRINGELEADER END-FIRED ARRAY**  
**RMS Model CVA-500**

- Completely preassembled.
- High gain on all channels.
- 3/8" dowel-reinforced aluminum elements with unique double U-bolt attachment to the mast.



**SUPER STEEL-BRACED**  
**YAGIS**

**RMS Model STYL8-**

- Cut for specific channel — one of the highest gain antennas in use today.
- Steel brace assures permanent orientation.
- Deluxe construction and engineering features — the fastest installing long boom yagi on the market!

SEE YOUR  
RMS JOBBER

**RMS**



2016 BRONXDALE AVENUE • NEW YORK 60, N. Y.





three TIME-SAVING

# OHMITE *Little Devil*<sup>®</sup>

**RESISTOR ASSORTMENTS**

**FOR RADIO-TV SERVICEMEN**



WITH HANDY

**PLASTIC CABINET**

**ALL FOR THE PRICE OF RESISTORS ALONE!**

Here's a handy all-plastic resistor cabinet that's a real time-saver. Five drawers, each with eight individually-labeled compartments, make it easy to locate the right resistor and to maintain visual stock control.

The 1/2-watt assortment contains 150 carefully selected Ohmite "Little Devil," individually marked, insulated composition resistors. The 1 and 2-watt assortments each contain 125 resistors. The assortments include the 40 values (10 ohms to 10 megohms) most frequently used by servicemen.

This cabinet is offered at the price of the resistors alone. See your jobber.



**CABINETS CAN BE STACKED ON EACH OTHER**  
A dovetail joint is provided on top and bottom of each cabinet so they can be stacked one on top of another.

**NEW YORK HAS EXPOSE**

The August 8 meeting of the Associated Radio-Television Servicemen of New York City (ARTSNY) was largely devoted to a discussion of the recent exposé of cut-rate service firms in the New York metropolitan area.

Although started under excellent auspices, including some unofficial assistance from the Association itself, it was pointed out that the project suffered somewhat through being handled by one of the more sensational local newspapers; with the result that proportion was sacrificed at times for dramatic effect. Emphasis was, however, placed on the 1- and 2-dollar service call, and the principal object of the investigation was to determine if a concern advertising such rates could operate legitimately.

Worst feature of the exposé was the "gimmick," that untypical and unnatural cause of TV maloperation that no service technician expects or is likely to look for. Worst example was a case where brilliancy was sharply reduced by turning down a screwdriver control. The service technician took one look at the set, replaced the tubes whose weakness would normally be responsible for the defect, adjusted the control, and charged for a service call plus the tubes replaced. The housewife's remark after he had gone: "Why, he wanted nearly ten dollars for doing practically nothing!" indicates the standard attitude toward a service technician who might have been audacious enough to try to collect the full price of a service call for turning up a control. One wonders if he would have charged the same or a higher fee in a normal case of reduced brilliancy, where the tubes actually would have needed replacement.

Another case involved the displacement of an ion trap. Although it was pointed out that this could have been a genuine defect (the householder told the service technician that the set hadn't worked since the room was cleaned that morning) it put the technician in the position of trying to charge for a service call after "doing practically nothing," or attempting to justify his call by selling a few tubes.

Best feature of the exposé was that local technicians were consulted before and during the investigation, and quoted in one of the concluding articles. Thus it was made quite clear to the reader who had followed the series that the operations of unethical service organizations were as harmful to the service technician as to the set owner, and that the service technicians were as interested as the public in eradicating unscrupulous practices and persons from the industry.

**FULL-TIME MANAGER**

The Certified Television and Electronics Association of Maryland announces the appointment of Donald H. Kresge as full-time business manager. Mr. Kresge has been a service technician, has operated several service organizations, and has worked as field engineer for the General Electric Co.

OHMITE MANUFACTURING CO., 4894 W. Flournoy Street, Chicago 44, Illinois

Be Right with **OHMITE**<sup>®</sup>

RHEOSTATS · RESISTORS · TAP SWITCHES

RADIO-ELECTRONICS



**NEW GROUP IN VIRGINIA**

Formed to combat the widely expressed distrust of TV and radio service practices, the Northern Virginia Electronics Association has drawn up a 5-point Code of Ethics:

1. All TV installations and repairs to antennas will be in accordance with local building- and electrical-code requirements.
2. Materials used must be of a grade approved by the Association, electrical and building inspectors, and the Underwriters' Laboratories.
3. All installations and antenna repairs are to be guaranteed for a minimum of 90 days.
4. All installations must be neat and clean, rigidly anchored, and at a safe distance from power lines; any property damage during installation must be reported at once to the owner and arrangements made for repair or replacement.
5. Workmanship must be excellent and rates fair and reasonable.

Association members also pledge themselves not to "slander, abuse, or belittle" fellow members, not to make false or misleading statements to customers, to advertise truthfully, supply customers with itemized accounts of all work done and all parts furnished, and to fulfill all guarantees and contracts they may make to their customers.

Charter members of the Association are six Arlington and one Falls Church (Va.) service dealers.

**COLUMBUS ACTIVE**

The Associated Radio-Television Service Dealers of Columbus, Ohio, included both a picnic and a Lake Erie trip in their summer recreational activities, according to the latest issue of the *A.R.T.S.D. News*. The same issue of the Columbus service dealers' monthly news sheet reports on the association's project to take care of the TV receivers at the Children's Hospital and the cerebral palsy institutions free of charge.

END

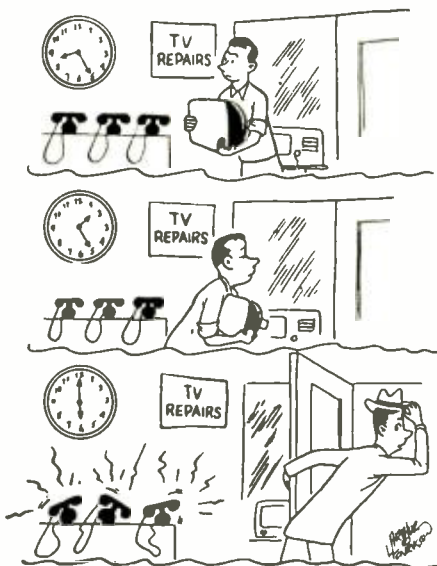

Introducing - an outstanding new cartridge in smart new "jewel-case" packing

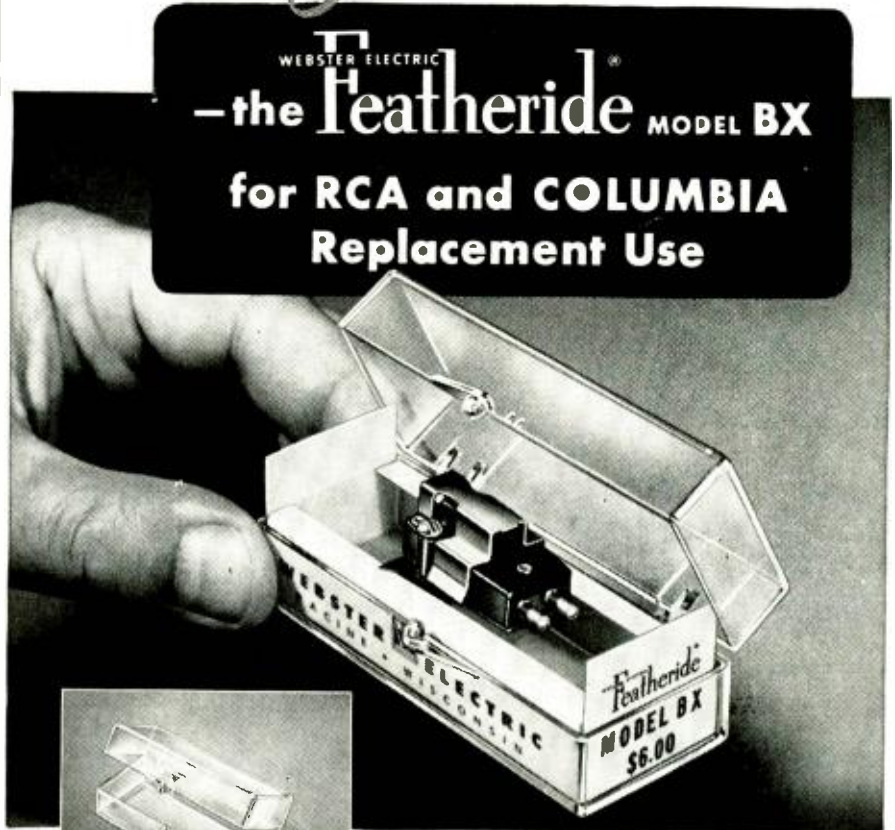

The Model BX is packed (suspended, and with needle guarded) in a beautiful Tenite "jewel case" with hinged cover... a case for which you and your customers will find countless uses.

- for installation ... in Columbia record players.
- for installation ... in R C A series RP 168 and RP 190 automatic record changers.
- for installation ... in RCA series RP 193-1 automatic record changers.

The new Featheride Replacement Crystal Cartridge Model BX meets the rapidly growing demand for a superior replacement cartridge for RCA automatic record changers and Columbia record players. It offers unusually high fidelity. Compact and light in weight, it tracks perfectly at only 7 grams pressure.

Like all Webster Electric replacement cartridges, the Model BX is protected against moisture and humidity by the famous Dri-seal crystal construction. Each cartridge is furnished with a 1-mil osmium needle, bracket and spring for installing in RCA's 168 and 190 series arms, also spacer nuts for installing in RP 193-1 series arms. With bracket and spring removed, it may be installed in Columbia or other 1/2" mounting arms. Send for Catalog Sheet No. RC 189.

**Specifications and Data**

Application: 33 1/3 and 45 RPM records.	Construction: Moulded plastic half-shells.
Output (1000 CPS): .05-.75 volts.	Mounting: Universal for RCA record changers and Columbia record players.
Tracking Pressure: 7 grams.	Terminals: Pin type.
Cut-off Frequency: 7000 CPS.	Needle: Osmium tipped, replaceable.
Weight: 10 grams.	
Size: See installation drawings.	

Webster Electric Co., Racine, Wis. ... Established 1909

**WEBSTER ELECTRIC**  
RACINE • WISCONSIN

"Where Quality is a Responsibility and Fair Dealing an Obligation"

Webster Electric Company, Clark and DeKoven Streets, Dept. RE-10, Racine, Wis.  
Please send me technical data on Featheride Pick-up Cartridges for replacement use.

Name \_\_\_\_\_ (Please print)

Address \_\_\_\_\_

City \_\_\_\_\_ State \_\_\_\_\_

Jobber  Service Technician  Zone  Other

# HERE'S YOUR WISEST BUY IN REPLACEMENTS!

## IRC Gives You Widest Variety —Greatest Dependability

You know the dependability of IRC resistors. But *do* you know their full replacement coverage? It's the *widest in the industry*—and that's worth knowing. For it means you can get the exact IRC part you need for any specific job—instead of running the risk of failures-in-service, so common with makeshift parts. Take a moment to look at IRC's replacement coverage. Then, for widest variety and greatest dependability, specify IRC.

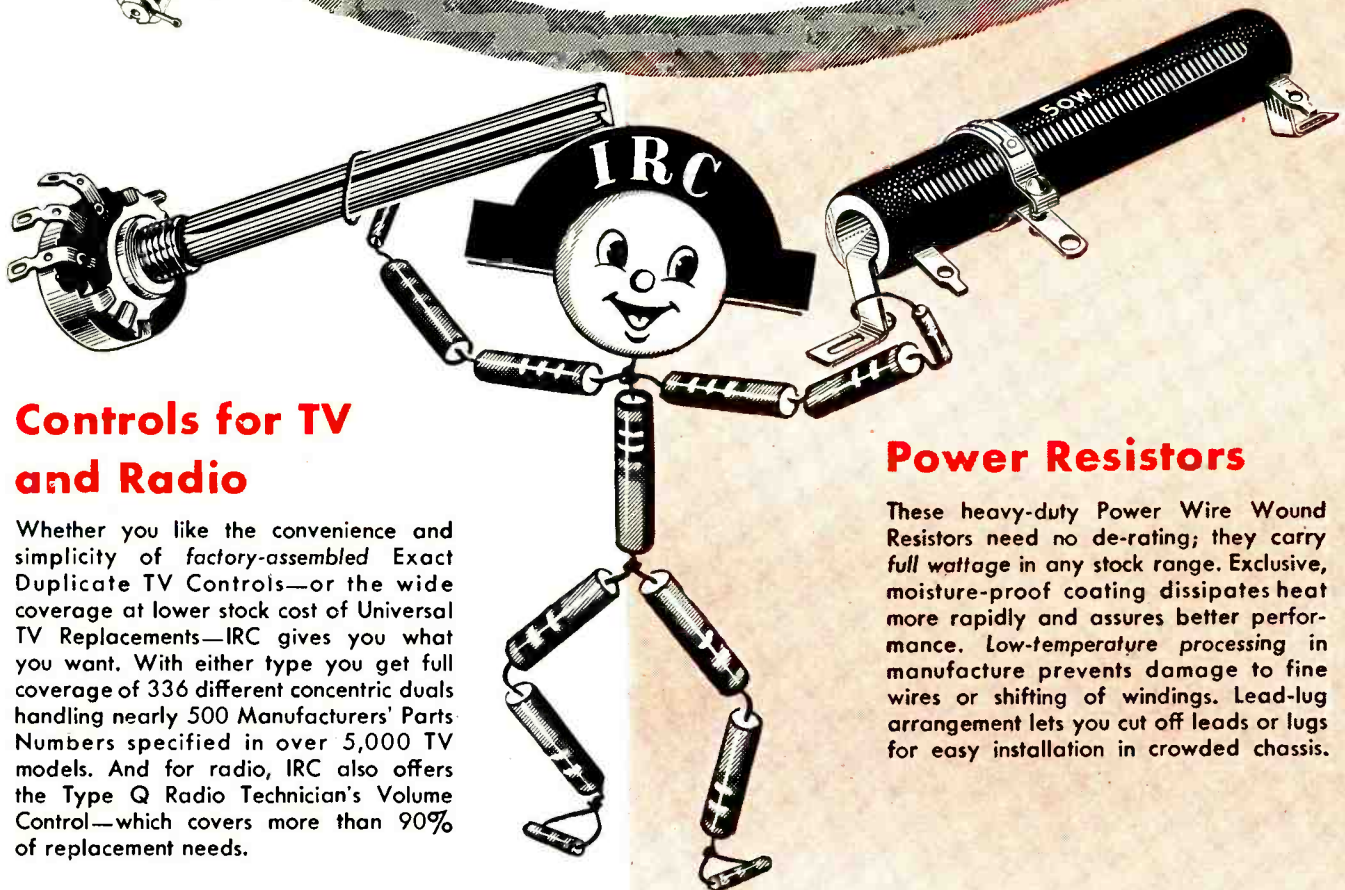
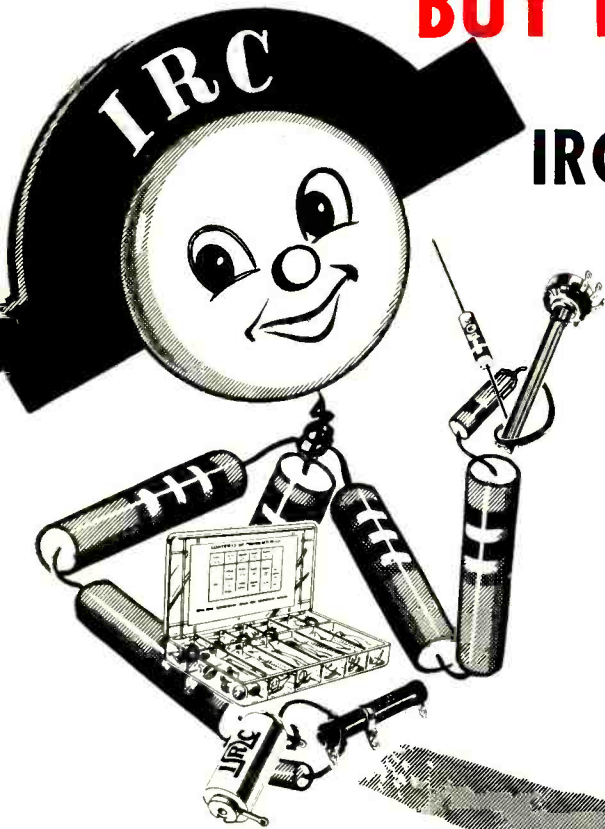

### Controls for TV and Radio

Whether you like the convenience and simplicity of factory-assembled Exact Duplicate TV Controls—or the wide coverage at lower stock cost of Universal TV Replacements—IRC gives you what you want. With either type you get full coverage of 336 different concentric duals handling nearly 500 Manufacturers' Parts Numbers specified in over 5,000 TV models. And for radio, IRC also offers the Type Q Radio Technician's Volume Control—which covers more than 90% of replacement needs.

### Power Resistors

These heavy-duty Power Wire Wound Resistors need no de-rating; they carry full wattage in any stock range. Exclusive, moisture-proof coating dissipates heat more rapidly and assures better performance. Low-temperature processing in manufacture prevents damage to fine wires or shifting of windings. Lead-lug arrangement lets you cut off leads or lugs for easy installation in crowded chassis.

MAKE YOUR IRC DISTRIBUTOR YOUR ONE-STOP SOURCE



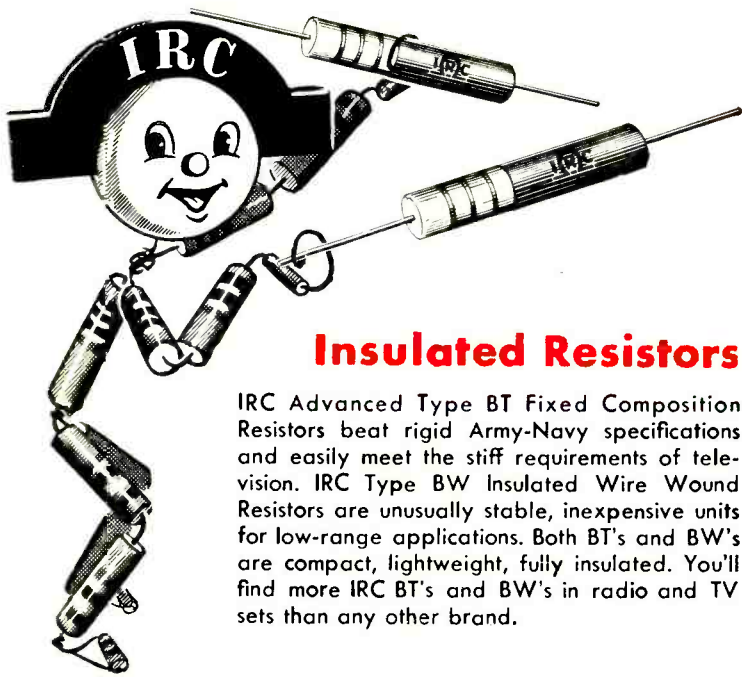

## Insulated Resistors

IRC Advanced Type BT Fixed Composition Resistors beat rigid Army-Navy specifications and easily meet the stiff requirements of television. IRC Type BW Insulated Wire Wound Resistors are unusually stable, inexpensive units for low-range applications. Both BT's and BW's are compact, lightweight, fully insulated. You'll find more IRC BT's and BW's in radio and TV sets than any other brand.

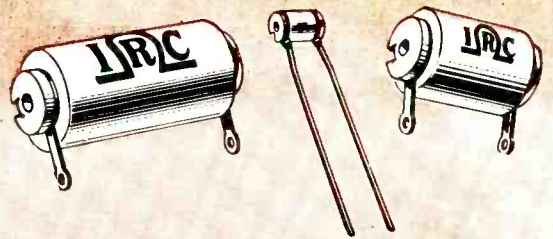

## Precision Resistors

These all-new, greatly improved IRC Precision Wire Wound Resistors far surpass critical Army-Navy specifications. New winding forms hold more wire for greater resistance. New winding technique eliminates shorted turns and winding strains. New insulation compound gives higher stability and freedom from noise—greater humidity resistance and longer life. New terminations provide greater strength in connections.



## Practical Stock Assortments

At no extra cost, IRC's handy metal Kits and Cabinets put the parts you use most right at your finger tips. Stocked with BT and BW resistors in the ranges most widely used in television—with Volume Controls and parts that cover more than 90% of Single Carbon Control Replacements—or with IRC Insulated Chokes, these handsome, compact kits save shopping time, eliminate clutter, improve your shop's appearance. There's even a flat, pocket-size kit for service calls or small bench stocks.

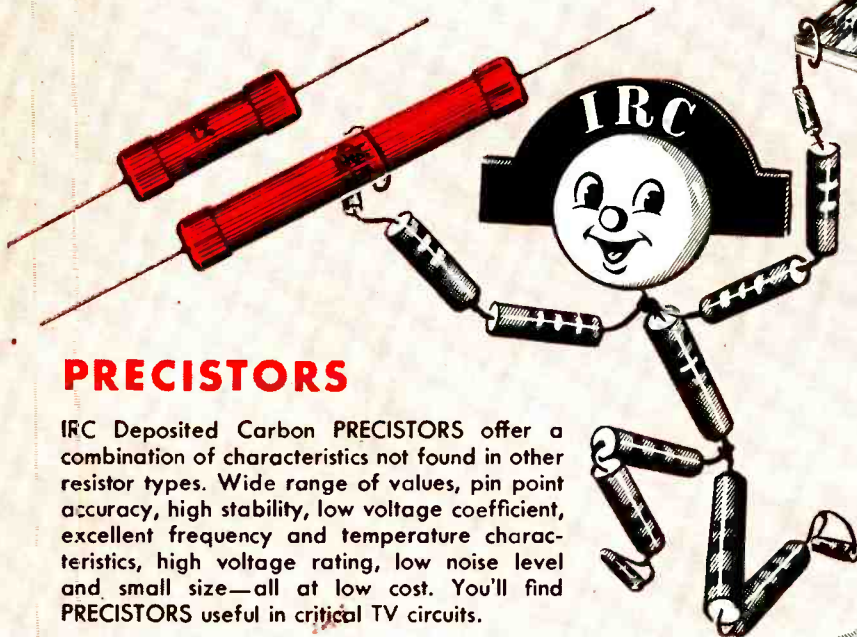

## PRECISTORS

IRC Deposited Carbon PRECISTORS offer a combination of characteristics not found in other resistor types. Wide range of values, pin point accuracy, high stability, low voltage coefficient, excellent frequency and temperature characteristics, high voltage rating, low noise level and small size—all at low cost. You'll find PRECISTORS useful in critical TV circuits.

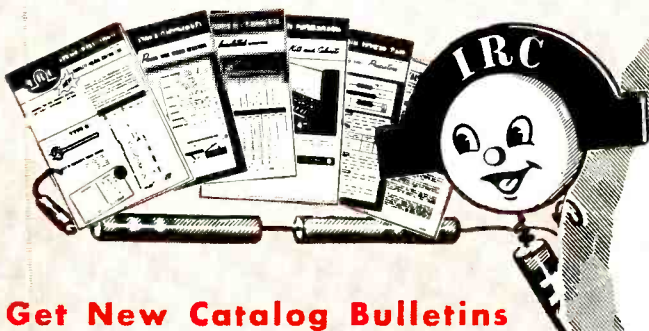

## Get New Catalog Bulletins

Your name and address on a post card will bring you Catalog Bulletins on any of these parts you specify. Or, if you wish, you can examine any of the products shown above at your IRC Distributor. For more profitable servicing, get the full IRC replacement story today.



**INTERNATIONAL RESISTANCE COMPANY**

401 N. Broad Street, Philadelphia 8, Pa.

In Canada: International Resistance Co., Ltd., Toronto, Licensee

*Wherever the Circuit Says ~~~*

**FOR ALL REPLACEMENT PARTS**



whatever  
your  
viewpoint...

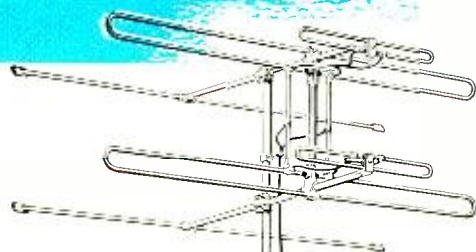

**—INLINE\***



dealer,  
installer or  
set owner...

The Amphenol Inline is the antenna for you! Stocking problems are minimized because the one antenna gives superb performance on *all* channels. Saves duplicate inventory of accessories too, because the Amphenol Inline is packaged for a quick, easy installation including twin-lead, mounting clamps, mast and stand-off insulators.

The aerodynamically clean design of the Inline preserves the neat appearance of the home and most important of all, regardless of viewpoint, is the fact that no broadband antenna now in existence can match the quality of the picture made possible by the Amphenol Inline Antenna.

See your Authorized Amphenol Distributor for your free copy of this 20-page booklet containing all the factors which determine Better TV Picture Quality.



**AMERICAN PHENOLIC CORPORATION**  
1830 South 54th Avenue • Chicago 50, Illinois

**AMPHENOL**



## New Devices

### TV BOOSTER

Alliance Mfg. Co., Lake Park Blvd., Alliance, Ohio has announced a new automatic television booster, the *Cascamatic*. The booster mounts on the back of a TV receiver, is easy to install, and turns on and off with the set. Pretuned to all channels, it contains three tubes.



### NEW LOUDSPEAKERS

Altec Lansing Corp., 9356 Santa Monica Blvd., Beverly Hills, Calif., has introduced two new loudspeakers. The 12-inch 601A and the 15-inch 602A have a frequency range from 30 to 22,000 cycles. Frequencies from 3,000 to 22,000 cycles are reproduced by a compact high-frequency unit, mounted in the center of the cone, through an exponential horn.

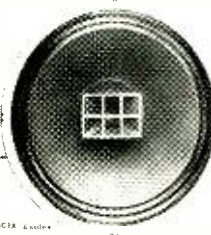
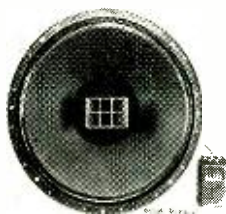

The two speakers are identical with the exception that 601A has a 12-inch cone and 602A a 15-inch one. As a result, the reproduction of frequencies below 50 cycles is somewhat better on the 602A although both speakers will reproduce fundamental tones down to 30 cycles.

### DISCHARGE CAPACITOR

Centralab Division of Globe-Union, Inc., Milwaukee, Wis., is producing a new type ultra-high-speed discharge capacitor which has the characteristics of 30 feet of solid coaxial transmission cable. The tube is 2-inches in diameter, 6 1/2 inches long. When used in the same manner as the coaxial cable, charged to 10,000 volts and discharged across a spark gap, the capacitor tube improves light intensity 900 times.



The tube is made of hi-K ceramic (K=2000), silvered inside and out. It has a capacitance rating of at least .024 ufd (24,000 µuf) and when immersed in transformer oil is rated at a working voltage of 20,000 volts d.c. The unit has a decay time, peak to peak, of  $2 \times 10^{-7}$  second, a rise time, zero to peak, of  $2 \times 10^{-7}$  second, and 50% of peak limits occur in a period of  $1.8 \times 10^{-7}$  second. Leakage resistance is over 10,000 megohms, and dielectric strength is approximately 35 volts per mil.

### NEW GENERATOR

Simpson Electric Co., 5200 W. Kinzie St., Chicago 44, Ill., has announced a new crosshatch pattern generator to make horizontal and vertical linearity, hold, height, width, and drive adjustments when transmitter test patterns are not available.

The Simpson model 485 provides a synchronized signal, modulated on the carrier frequencies of channels 2 through 6, which can be tuned and sent through the receiver under test. When the receiver has been properly adjusted, the signal will show equally spaced lines in vertical, horizontal, or crosshatch patterns on the picture tube.

All patterns are locked in place with synchronizing pulses exactly the same as the sync pulses in transmitted waveforms, making it unnecessary to double-check against an actual trans-



mitted test pattern. The output cable includes a variable termination network which can be adapted quickly to provide 75- or 300-ohm terminations for matching receiver inputs.

### TUBE TESTER

Electronic Instrument Co., Inc., 84 Withers St., Brooklyn 11, N. Y., has released its new model CRA television picture-tube test adapter.

Model CRA gives a quantitative measurement of cathode emission and tests for filament continuity and interelement shorts when used with an Eico tube tester. It is supplied with standard 12-pin picture-tube socket; actual plug-in connector for the tube tester and an extra-long 4-foot cable that enables the picture tube to remain in the set while testing.



### ANTENNA KITS

Channel Master Corp., Ellenville, N. Y., has a new master antenna kit which includes all components necessary for the average home television installation. In addition to the antenna, each kit contains a floor mount, screw eyes, guy ring and clamp, swaged mast, standoff insulators, lightning arrester, 300-ohm ribbon transmission line, and guy wire.

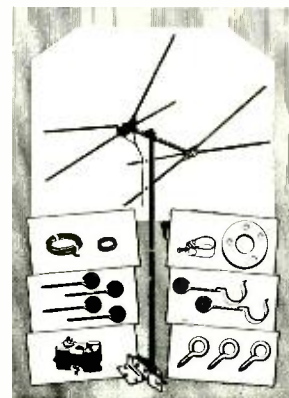

RADIO-ELECTRONICS







**UHF CONVERTER**

Regency Division, I.D.E.A., Inc., 7900 Pendleton Pike, Indianapolis, Ind., has announced a new converter for adding u.h.f. station reception to any TV set. The cabinet is a companion in style to the Regency television signal booster.

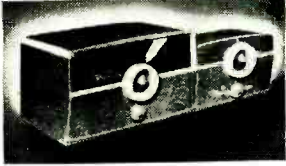
**HAM-BAND FILTER**

Grayburne Corp., 103 Lafayette St., New York 13, N. Y., has designed a TV interference filter to alleviate 21-mc ham-band interference. The model CPH Clear-Pix Filter has high rejection efficiency for the 21-mc band.

**INSULATED PLIERS**

General Cement Mfg. Co., Rockford, Ill., has developed an insulated pair of long-nose plastic pliers for TV technicians and others working around high voltages. The pliers are 8/4 inches in length, and are claimed to be absolutely shockproof. The tool is made of high-impact bakelite material.

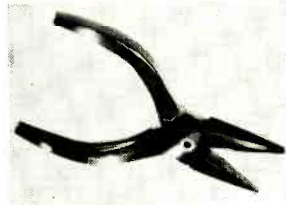
**VOLUME CONTROLS**

P. R. Mallory & Co., Inc., 3029 E. Washington St., Indianapolis, Ind., has announced the addition of a 2-watt wire-wound front control section to the line of selective-assembly dual concentric Midgetrols.

Known as the "WF" series, the sections are available in ten resistance

values from 750 to 7,000 ohms in topped and untapped types. They may be employed in conjunction with any of the previously announced "UR" carbon rear control sections to fabricate a dual concentric volume control of exact replacement characteristics.

An inner shaft, phenolic spacer, and special coupling cup and shaft end are supplied with each "WF" control section. Instructions permit assembly without special tools or soldering.

**TAPERED GERMANIUM DIODES**

Radio Receptor Co., Inc., 251 W. 19th St., New York 11, N. Y., is using a new tapered design in its germanium diodes. The tapered hexagon-shaped body shows polarity at a glance—the taper shows the direction of current flow, permits mounting against a flat surface, and speeds up assembly operations. The diode consists of a



germanium wafer soldered to a nickel alloy cathode pin, and an electro-etched tungsten whisker welded to a nickel alloy anode pin, assembled into the glass-phenolic body. It may be clip-mounted by the terminal pins or soldered in by the pigtail leads.

Available JAN types are 1N69 general-purpose and v.h.f. rectifier unit, 1N70 high-voltage diode, and 1N81 medium-voltage diode with low back leakage near 10 volts. Commercial types are 1N48, 1N51, 1N52, 1N63, 1N64, 1N65, and 1N75.

**TV LEAD-IN SHEATHS**

Don Good, Inc., 1014 Fair Oaks Ave., South Pasadena, Calif., announces four new protective coverings for 300-ohm transmission lines. *Lead-Sheath* is a protective tubing of pure polyethylene into which the lead-in is threaded to protect it from sunlight, salt spray, frost, snow, and icy conditions. *Lead-Sheath* is manufactured in a standard brown (No. 100) and silvery-gray (No. 120) colors. It is packaged on 750-foot reels, with shorter lengths available.

*Sheath-Lead* No. 803 is standard brown 300-ohm *Goodline Airlead* enclosed in a brown polyethylene tube. *Sheath-Lead* No. 823 is the clear *Good-*



*line Airlead* shielded from ultraviolet light and the elements by silvery-gray *Lead-Sheath*.

Nos. 803 and 823 are packaged on 1,000-foot reels, with shorter lengths available.

**70-VOLT TRANSFORMERS**

Standard Transformer Corp., 3580 Eiston Ave., Chicago, Ill., has added two new line-to-voice coil transformers to its line of components for 70-volt audio distribution systems. The A-8102 and A-8103 operate into 4-, 8-, or 16-ohm loads from 70.7-volt lines or from one or more of the speaker-distribution-line voltages in a series derived by successive multiplication or division of

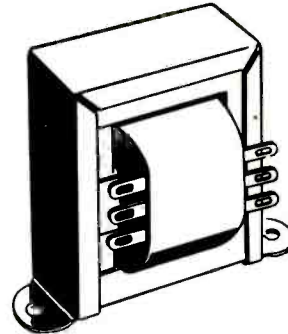

70.7 volts by 1.414. When properly terminated in its rated impedance, power output ratings for the A-8102 are 8, 4, 2, 1, and 0.5 watts and 16, 8, 4, 2, 1, and 0.5 watts for the A-8103.

**PRECISION OSCILLOSCOPE**

The Instrument Division, Allen B. DuMont Laboratories, Inc., 1500 Main Ave., Clifton, N. J., announces the type 303-A wide-band, high-gain cathode-ray oscilloscope for the study of pulses and other highspeed phenomena. In addition to the conventional qualitative analysis, the 303-A can be used for precise quantitative measurement of both time and amplitude.

Nominal bandwidth is 10 mc, with a transient response of 0.033  $\mu$ sec. The gradual fall-off of the Y-axis frequency response permits signals as high as 20 mc or more to be usefully displayed. Sweep durations are variable from

0.1 second to 2  $\mu$ sec. All sweeps may be expanded up to six times full-screen diameter, with full positioning available over the entire range. With expansion, maximum sweep speed is 10 inches per  $\mu$ second. Much higher sweep speeds may be obtained at some sacrifice in positioning and linearity; however time measurements may still be made accurately. Amplitude and timing calibration are provided by built-in voltage and frequency standards of high accuracy.

The deflection factor of the vertical amplifier is 0.1 volt peak-to-peak per inch, with 1.5 inches of undistorted deflection for unidirectional signals, and three inches for symmetrical signals.

An illuminated calibrated scale with light level varied with a front-panel control is provided as standard equipment. A filter of a color appropriate for the screen type is provided with the individual instrument. Also supplied as standard equipment is a shielded coaxial-cable adapter with 52-ohm termination for connection of the input signal to the scope through a coaxial cable.

**CORNER BAFFLE**

The Permoflux Corporation, 4900 West Grand Ave., Chicago 39, Ill., has designed a new type of baffle designed to fit in the corner of a living room.

Due to the corner placement, the tone qualities are reinforced to give a sparkling performance from a low of 30 cycles to a high of 12,000 cycles per second.

Specifications, Model CB-8-M: Height 24, width 14 inches, depth at top 9/2, at bottom 13 3/4 inches. Frequency response, 30 cycles to 12,000 cycles. Rich mahogany (Ordoval) leatherette; four-layer plywood construction. **END**

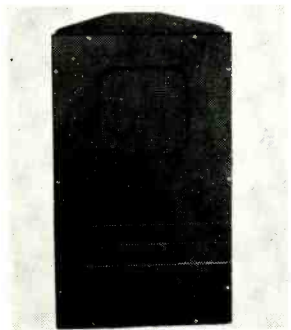

All specifications given on these pages are from manufacturers' data.



Regency



Largest Selling Booster

AT ANY PRICE!



# GREYLOCK SLASHES PRICES!

QUALITY • PRICE • SERVICE

All tubes listed below carry 6-month guarantee—excepting only burnouts and breakages. At these sensationally low prices, these tubes must be ordered in quantities of AT LEAST 10 ASSORTED TYPES. (Add 10% for orders under 10 tubes.) All individually boxed in attractive GREYLOCK Cartons.

OZ4M .59	354 .59	6AT6 .49	6C4 .49	6SG7 .89	7A4 .69	12AX7 .59	25BQ6GT .79
1A7GT .79	3V4 .59	6AU6 .49	6CSGT .49	6SH7 .79	7A8 .89	12AZ7 1.29	25L6GT .59
1B3GT .99	5U4G .69	6AV6 .49	6C6 .49	6SJ7GT .69	7B6 .59	12BA6 .49	25W4GT .49
1H5GT .69	5V4G .99	6AX4GT .69	6CB6 .49	6SK7GT .49	7B7 .89	12BA7 .99	25Z5 .49
1L4 .49	5Y4G .59	6AX5GT .79	6CD6G 1.49	6SL7GT .69	7C6 .89	12BD6 .59	25Z6GT .69
1LA4 .89	5Y3GT .49	6BA6 .49	6E5 .79	6SN7GT .59	7C7 .89	12BE6 .49	35B5 .59
1LC5 .79	5Y4G .69	6BC5 .69	6F6GT .59	6SQ7GT .59	7L7 .99	12BH7 .99	35C5 .59
1LD5 .99	6AB4 .69	6BD5GT 1.09	6H6 .59	6SR7 .69	7N7 .79	12J5GT .59	35L6GT .69
1LN5 .89	6AC7M 1.09	6BD6 .59	6J5 .49	6T8 .79	7X7 .79	12O7GT .69	35W4 .49
1NSGT .69	6AG5 .69	6BE6 .49	6J6 .89	6U4GT .59	8O7 1.79	12SA7GT .79	35Y4 .69
1R5 .59	6AG7M 1.19	6BF5 .69	6J7 .49	6U5 .69	12ABGT .49	12SK7GT .69	35Z5GT .49
1S5 .49	6AH6 .99	6BG6G 1.29	6K6GT .59	6U8 .89	12AL5 .79	12SN7GT .79	41 .69
1T4 .59	6AK5 .89	6BH6 .69	6L6GT 1.19	6V3 1.59	12AT6 .49	12SO7GT .69	45 .69
1U4 .49	6AL5 .49	6BJ6 .79	6L6GA 1.19	6V6GT .49	12AT7 .79	12S8GT .79	50B5 .59
1U5 .49	6AQ5 .49	6BK7 .89	6S4 .49	6W4GT .49	12AU6 .49	14A7 .99	50C5 .59
1X2 .99	6AQ6 .69	6BL7GT 1.09	6S8GT .49	6W6GT .79	12AU7 .99	14B6 .99	50L6GT .59
3A4 .59	6AR5 .59	6BN6 1.09	6SA7GT .69	6X4 .49	12AV6 .59	14Q7 .99	80 .59
3A5 .79	6AR6 2.49	6BQ6GT .79	6SC7 .99	6X5GT .49	12AV7 .59	19B6G6 1.29	117Z3 .49
3LF4 1.09	6AS5 .69	6BQ7 1.49	6SD7GT .79	6Y6G .79	12AX4GT .69	19T8 .99	FM-1000 .89
3Q4 .49							7JP4 16.50

**FAMOUS BRAND TV BOOSTER**  
  
 Model DB-410  
 While present \$14.95 stocks last!

**WEBSTER N-10 CARTRIDGES**  
  
 Exact repl. for L72A, 82A \$1.95

**CRYSTAL PICKUPS**  
  
 Complete  
 Webster N-7 \$1.95  
 Astatic L71A \$2.60  
 Astatic L82 \$2.60

**Clarostat Vol. Controls Reduced**  
  
 Flat shaft, SPST switch, indiv. boxed. 5M, 10M, 100M, 250M. Your Choice, each .35e  
 Kit of 4 controls, 1 each of above \$1.25

**TV VARIABLE CONTROLS**  
  
 Pix & Sound, 10M ohms, 1 Meg W/SPST switch \$.79  
 Vert. & Horiz.  
 50M ohms, 1 Meg. \$ .69  
 Focus & Bright, 50M ohms, 2250 Ohms. \$ .59  
 Kit of 3 (1 ea.) \$1.98  
 Kit of 6 (2 ea.) \$3.89

**McMURDO SILVER TV PREAMPLIFIER**  
  
 Simple to hook up, instructions included. Special, while they last! \$9.95

**TELEVISION E-Z-I LIGHT & ELECTRIC Self-Starting CLOCK.** Walnut, square face \$6.95  

**SPEAKER SPECIALS**  
 All PM speakers have Alnico V slugs.  
 3" OM .68 oz \$1.29  
 4" or 5" PM .68 oz 1.29  
 4"x6" PM 1 oz 1.39  
 6" PM 1 oz 1.59  
 5"x7" PM 1.47 oz 1.89  
 6"x9" PM 3.16 oz 3.49  
 8" PM 2.15 oz 3.69  
 10" PM 6.8 oz 5.95  
 12" PM 3.2 oz 4.95

**AUTO SPEAKERS**  
 7 1/4" 4 ohm less output 2.19  
 7 1/2" PM less output 4.95  
  
**Lindstrom 78 RPM PHONO MOTOR**  
 With 9" Turntable \$1.49

**TV PICTURE TUBE REJUVENATOR**  
  
 Simple to use, puts new life into old picture tubes \$2.79

## STANDARD BRAND TUBES INDIVIDUALLY BOXED

Manufacturers of tubes do not permit mentioning their names because tubes are FAR BELOW FAIR TRADE. 6 Month guarantee, excepting burnouts and breakages.

OZ4G .69	6C4 .59	34 .99
1A5GT .69	6CSGT .69	35/51 .79
1A7GT .89	6CB6 .69	35B5 .79
1B3/8016 .99	6CD6G 2.39	35L6GT .79
1E7 .59	6F6 .69	35W4 .49
1H4G .59	6H6M .69	35Y4 .69
1H5GT .69	6J5GT .59	35Z5GT .49
1N5GT .79	6J6 .99	36 .69
1Q5GT .99	6J7GT .89	37 .69
1R5 .79	6K6GT .59	39/44 .69
1S4 .99	6N7M .99	47 .99
1S5 .79	6R7GT .99	50A5 .99
1T4 .79	6S4 .69	50C5 .69
1T5GT .99	6SA7M .69	50L6GT .69
1U4 .79	6SG7M .89	56 .59
1X2 .99	6SH7GT .89	57 .59
3D6/1299 .59	6SJ7GT .69	58 .59
3Q4 .89	6SK7GT .69	76 .69
3Q5GT .99	6SL7GT .79	77 .69
354 .79	6SN7GT .79	117Z6GT 1.09
3V4 .79	6SQ7GT .59	11A4 .99
5U4G .69	6T8 .99	11C5 .99
5V4G .99	6V6GT .69	11G5 .99
5Y3GT .49	6W4GT .69	11E3 1.19
5Z3 .79	6X5GT .59	11G5 1.19
6AB4 .79	6Y6G .99	11H4 1.19
6AC7 1.09	12A6 .69	11N5 .99
6AG5 .79	12AT6 .69	11LH4 1.19
6AG7 1.29	12AT7 .69	7A8 .89
6AH6 1.29	12AU6 .69	7B7 .89
6AK5 1.29	12AU7 .89	7C6 .89
6AL5 .69	12AV6 .69	7C7 .89
6AQ5 .69	12AV7 1.19	7E5 .79
6AR5 .69	12BA6 .69	7E6 .79
6AR6 2.49	12BE6 .69	7E7 .79
6AT6 .59	12BH7 .99	7H7 .89
6AU5 1.29	12J5GT .59	7N7 .89
6AU6 .69	12K8GT .69	7L7 1.09
6AV6 .59	12SA7GT .79	7O7 .89
6AX5GT .79	12SJ7GT .69	7V7 1.29
6A3 .99	12SK7GT .79	7Z4 .69
6A7 .99	12SN7GT .89	14A4 .79
6BA6 .69	12SO7M .69	14C5 .99
6BC5 .79	12SQ7GT .69	14F7 .89
6BG6G 1.69	19B6G6 2.39	14F8 1.19
6BL7GT 1.29	25BQ6 .99	14J7 .99
6BN6 1.29	25L6GT .69	14Q7 .99
6BQ6GT 1.29	25W4 .79	14R7 .99

Dept. C-10

**GREYLOCK'S FINEST "BONDED" CONDENSERS**  
  
 Unit price in lots of ten or more assorted, shown. Additional 10% off for orders of 100 or more assorted.  

Mfd	WVDC	Each
16	150	\$ .29
24	150	.35
30	150	.35
40	150	.39
20X20	150	.39
20X40	150	.39
30X30	150	.44
40X40	150	.45
50X30	150	.45
8	450	.29
8X8	450	.49
16	450	.39
30	450	.44
40	450	.49

**TUBULAR ELECTROLYTIC KITS**  
 Fine assortment, popular types for radio, TV service.  
 10 condensers \$1.49  
 25 condensers \$3.69

**"DOOR-KNOB" CERAMIC**  
  
 Hi-Voltage  
 500 Mmfd 20 Kv. .59  
 500 Mmfd 10 Kv. .29

**INSULATED RESISTORS**  
  
 1/4 & 1/2 Watt, Kit of 100 Assd. \$2.25  
 1/2 Watt A-B & IRC, separated, in plastic container, 20 popular sizes \$4.85

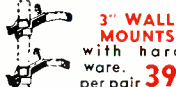
**3" WALL MOUNTS**  
  
 with hardware, per pair \$3.95

**300 OHM TWIN LEAD**  
  
 \$12.95 per M ft.  
 \$ 1.49 per C ft.

**CAN TYPE CONDENSERS**  
  
 Separate Leads, 450 V. Working.  

Mfd	Size	Net
8	1 1/2"x3	.59
12	1 3/8"x3	.65
16	1 3/8"x3	.69
20	1 3/8"x3	.79
30	1 3/8"x3	.89
40	1 3/8"x3	1.05
8-8	1 3/8"x4	.75
8-16	1 3/8"x4	.89
16-16	1 1/2"x4	1.05
20-20	1 1/2"x4	1.19
8-8-8	1 1/2"x4	1.05

 5% off, lots of 50 assd.  
 10% off, lots of 100 assd.

**TUBULAR PAPER BYPASS CONDENSER KITS**  
  
 100 Assd, 400 WV \$4.95  
 100 Assd, 600 WV \$5.95

**DEFLECTION YOKES**  
  
 63" RCA 20SD1 \$ .99  
 70" Type 206DI \$ 2.99  
 60" Type 201DI \$ 2.49

**ION TRAPS Permanent Magnets.**  
  
 Single, 203D1 \$ .39  
 Double, 203D3 \$ .69

**HORIZ. OUTPUT & HI-VOLT FLYBACK**  
  
 TRANS., for 16", 17" Pix Tubes \$2.99

**EXTRA!**  
 5% ADDITIONAL DISCOUNT ON ANY ASSORTMENT OF 100 TUBES OR MORE!

All Prices F.O.B. NYC. Please include postage and insurance with your remittance. 25% deposit on all C.O.D. orders. 50c Handling charge on orders under \$5.00.

**THE LADY SAYS SHE WANTS A SET WITH  
A HOT FRONT END... SHOW HER THOSE NEW  
MODELS WITH THE TARZIAN TUNERS**



● Since the early days of Television, the TARZIAN TUNER has been used exclusively by—and is closely identified with—most of the nation's leading set manufacturers. The TARZIAN TUNER is an outstanding engineering achievement. For selectivity... unexcelled stability... and trouble-free performance, the TARZIAN TUNER is recognized as a leader in the industry.

And, the full band—all channel—approach to UHF is a further example of Tarzian pioneering "in the right direction." Isn't it only natural that the world's largest producer\* of switch-type tuners should produce the best?

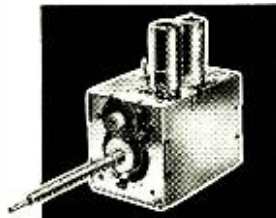

\*SARKES TARZIAN, Inc., Tuner Division, Bloomington, Indiana

**TARZIAN MADE PRODUCTS**

Tuners                      Air Trimmers                      Selenium Rectifiers                      Cathode-Ray and Receiving Tubes

STATIONS WTTT (5000 WATTS) AND WTTV (CHANNEL 10)  
OWNED AND OPERATED BY SARKES TARZIAN IN BLOOMINGTON

**NEW! MOSLEY WALL-THRU**



Cat. No. 625  
List Price \$1.95

Cat. No. 625-PK WALL-THRU, complete with MOSLEY Universal TV Lead-In Socket and Plug.  
List Price \$3.00

- For TV, FM and Amateur Transmission Line**
- Fits Any Wall Up To 13" Thick!
  - Completely Weather-Proof!
  - For Standard Flat 300 Ohm Line or RG-59/U Co-ax Cable!
  - MOSLEY Lead-In Socket Can Be Mounted Direct To Inside Plate!
  - Precision Molded Polystyrene End Plates!
  - Easily, Quickly Installed!

**MOSLEY ELECTRONICS**

2125 Lackland Road                      Overland, Missouri

**LIGHT AMPLIFIER**

Patent No. 2,594,740  
Lee deForest, Los Angeles, Calif.,  
and William A. Rhodes, Phoenix, Ariz.

This device can amplify both light and invisible radiation. It consists of a glass or plastic base on which various thin layers are sprayed, deposited, or coated. Nine such layers are shown here at the right of the glass base.

The first layer is photoemissive. When light shines through the glass into the layer, electrons are emitted. They move through the second layer, a wire screen or grid connected to B1. The particles then continue through the grid into the

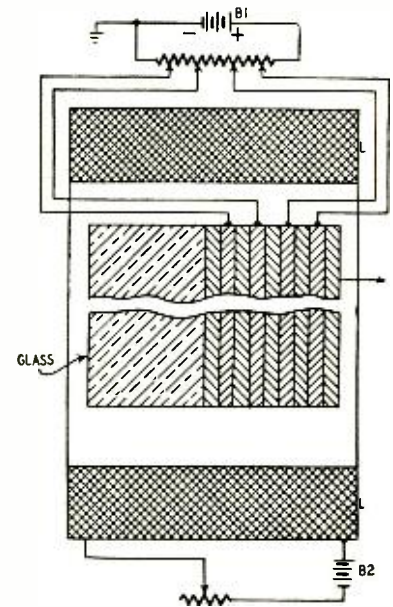

third layer, prepared for secondary emission. As many as 10 electrons may be emitted for each primary electron. The secondary particles are accelerated by the fourth layer, a wire grid also biased positively by B1. These four layers comprise one stage of the light amplifier.

The figure shows a second stage of amplification following the first, accounting for 8 of the 9 thin laminae. The output is a greatly magnified electron beam which is fed into the last layer. This one is fluorescent. It glows when electrons strike it. The output light beam may be hundreds of times more intense than the input light beam.

A coil L surrounds the amplifier. Current from B2 generates a magnetic field within this coil. It forces all electrons to move in the same general direction (toward the output). Spreading is prevented and the output image remains sharply focused.

**SIGNAL SELECTION**

Patent No. 2,593,600  
Winthrop S. Pike, Princeton, N. J.  
(Assigned to Radio Corp. of America)

This circuit separates frequencies which make up a composite signal. Such a signal is often used between a TV transmitting station and a portable TV pickup. The composite includes a 60-cycle pilot tone for synchronization purposes as well as audio for telephone messages.

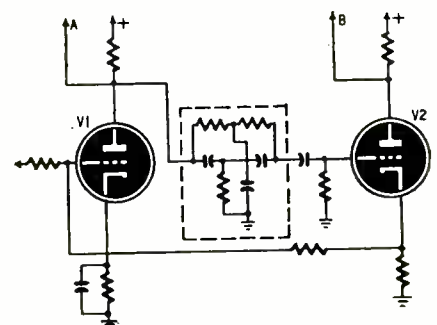

RADIO-ELECTRONICS



# 50% More for Your Money!

With "SILENCER"

... the amazing new Volume Control and Contact Restorer!

**3 OZ. (NOT 2 OZ.)**

FOR **\$1.00** RETAIL

(dropper included)

- One drop of "Silencer" instantly eliminates all noise indefinitely.
- Cleans, restores volume controls, band switches, push button assemblies, tuners, etc.
- For superior to temporary carbon tetrachloride.
- Not an oil that changes capacities and gums controls.
- Tested, approved and used extensively by thousands of servicemen.

**FREE** See your jobber for FREE Sample of "Silencer" or write factory direct for sample.

**ORDER FROM YOUR JOBBER TODAY!**

Dept. RE-10-52



**ILLINOIS RESEARCH LABORATORIES**

22 West Madison St., Chicago 2, Ill.  
Financial 4-0456 Suite 900



# IT'S A SHAME

to throw away that beautiful old Console . . . replace the obsolete radio with a modern, easily-installed

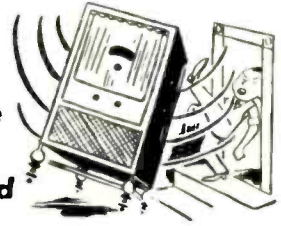

## ESPEY AM / FM CHASSIS

and your console is "right-up-to-date"



It is not necessary to spend a large sum of money to modernize your old radio or to become a "High Fidelity" enthusiast. ESPEY chassis provide the Highest Quality at moderate prices.

Fully licensed under RCA and Hazeltine patents. The photo shows the Espey Model 511-C, supplied ready to play. Equipped with tubes, antenna, speaker, and all necessary hardware for mounting.

**NEW FEATURES**—Improved Frequency modulation circuit, drift compensated • 12 tubes plus rectifier, and pre-amplifier 12AT7 tube • 4 dual purpose tubes • High quality AM-FM reception • Push-pull beam power audio output 10 watts • Switch for easy changing to crystal or variable reluctance pick-ups • Multi-tap audio output transformer supplying 3.2—B—500 ohms.

Makers of fine radios since 1928.

Write Dept. RE-10 for literature and complete specifications on Model 511-C and others.

**ESPEY**

**MANUFACTURING COMPANY, INC.**

528 EAST 72nd STREET, NEW YORK 21, N. Y.

# FIX ANY RADIO

## Amazing New Invention

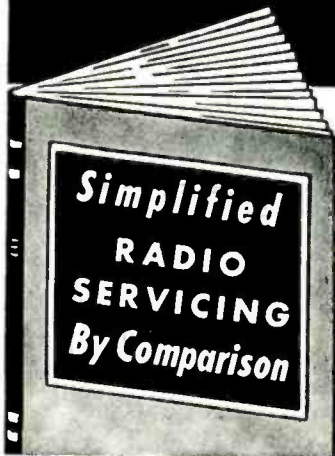

Find radio faults with a new simplified method. Repair all radios in minutes instead of hours. Revolutionary, different Comparison technique permits you to do expert work almost immediately. Most repairs can be made without any test equipment. Simplified point-to-point, cross-reference, circuit suggestions locate faults quickly and easily.



### NO TESTERS NEEDED

This newly developed method tells you how to locate the source of trouble in any radio set without equipment. Make needed tests, measure voltage, trace the signal, by using only a 5¢ resistor, small condenser, and a crystal detector. Inject signals without any signal generator. Test parts by the new Comparison method. Test tubes without equipment. Repair any radio expertly following simplified picture plans. Improve your radio servicing ability. Data on all sets, portables, FM, AC-DC, P.A., inter-coms, clock radios. Send coupon.

### CHARTS, BLUE-PRINTS, TESTS

Learn time-saving trouble-shooting short-cuts: find any radio fault with ease. Follow the tests shown on 24 large circuit blueprints. Gives over 1,000 practical repair hints. For all types of radios. Hundreds of simplified tests using only a 5¢ resistor and any filter condenser. Introductory material to help beginners. Several chapters on test equipment. Complete plan in manual form, 61 job-sheets, data on all tubes, 92 large pages, 8 1/2 x 11 inches. Schematics, pictures, charts. Sold on no-risk trial. Price, only \$1.50. Use coupon below.

### Supreme Radio & TV Manuals

Your complete source of all needed RADIO and TV diagrams and service data. Most amazing. Still sold at pre-Korean prices. Only \$2 in best volumes. Every Radio manual contains large schematics, all needed alignment facts, parts list, voltage values, trimmers, dial stringing, and service hints. Each TV manual is a practical guide on servicing the year's sets, with glass, eprints, patterns, waveforms, charts, suggestions, and changes. See coupon at right for a complete list of these low-priced manuals.

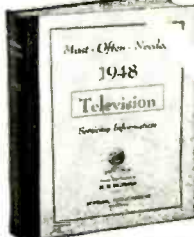

**Supreme Publications**  
Sold by All Leading Radio Jobbers

### NO-RISK TRIAL ORDER COUPON

**SUPREME PUBLICATIONS, 3727 W. 13th St., Chicago 23, ILL.**

#### Radio Diagram Manuals

- New 1952 Manual, \$2.50
- 1951 Radio Manual, EACH
- 1950 Manual, EACH
- 1949 Radio Manual, EACH
- 1948
- 1947
- 1946
- 1942
- 1941
- 1940
- 1939
- 1926-1938 Manual, \$2.50

**\$2.50**  
**PRICED AT ONLY \$2 EACH**

Send Radio and TV manuals checked  at left and below. Satisfaction guaranteed or money back.

- Simplified Radio Servicing (Fix Any Radio) \$1.50
- 1952 Television Manual, \$3.       1951 TV, \$3.
- 1950 Television Manual, \$3.       1949 TV, \$3.
- 1948 TV, \$3.       1947 TV & FM, only \$2.

I am enclosing \$..... Send postpaid.

Send C.O.D. I am enclosing \$..... deposit.

Name: .....

Address: .....

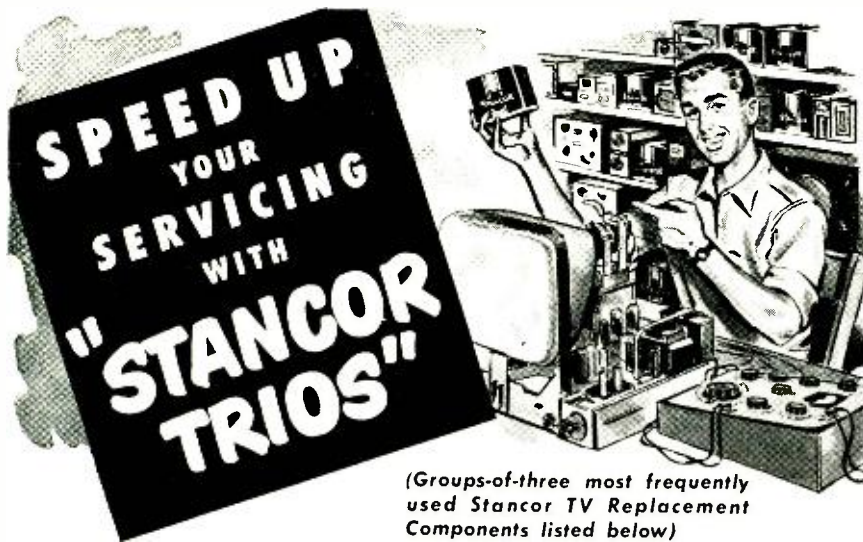

**Don't Waste valuable time waiting for a replacement—carry it in stock!**

STANCOR CHOKES	C-2325 C-2326 C-2327	<b>COVER 70%</b> of your TV REPLACEMENTS*
STANCOR DEFLECTION YOKES	DY-1 DY-8 DY-9	<b>COVER 70%</b> of your TV REPLACEMENTS*
HORIZONTAL DEFLECTION OUTPUTS	A-8127 A-8128 A-8130	<b>COVER 45%</b> of your TV REPLACEMENTS*
VERTICAL DEFLECTION OUTPUTS	A-8112 A-8115 A-8123	<b>COVER 70%</b> of your TV REPLACEMENTS*
VERTICAL BLOCKING OSCILLATORS	A-8111 A-8121 A-8122	<b>COVER 65%</b> of your TV REPLACEMENTS*

\* Based on a statistical analysis of all replacement recommendations in the Stancor TV Replacement Guide.

Stancor Transformers are listed in HOWARD W. SAMS' Photofact Folders and JOHN RIDER'S Tek-Files.

**FREE!** Stancor's new 24-page catalog listing over 475 transformers and related components for all types of electronic applications. Includes over 100 TV units. Get your free copy from your Stancor distributor or write Stancor direct!



**STANDARD TRANSFORMER CORPORATION**  
3592 ELSTON AVENUE, CHICAGO 18, ILLINOIS

**OVER 50,000  
TECHNICIANS  
HAVE LEARNED**



**'SERVICING BY  
SIGNAL SUBSTITUTION'**  
A BEST SELLER FOR OVER 12 YEARS!  
(NEW, UP-TO-DATE, 12th EDITION)

**HOW TO GET  
THE MOST OUT  
OF BASIC TEST  
EQUIPMENT**

**ONLY 40¢**  
103 pages. Invaluable information that will help you *really* double the value of your basic test equipment.

The Modern, Simplified, Dynamic Approach to Receiver Adjustment & Alignment Problems.

- ★ Nothing complicated to learn
- ★ No extra equipment to purchase
- ★ Universal... non-obsolete
- ★ Employs only Basic Test Instruments

Ask for "S.S.S." at your local Radio Parts Jobber or remit 40¢ in small stamps or coin directly to factory.

**PRECISION APPARATUS COMPANY, INC.**  
92-77 HORACE HARDING BLVD., ELMHURST 4, N. Y.

for A.M. - F.M. - TV

A parallel-T network (shown in the dotted box) couples the two triodes. This network passes all frequencies except the one to which it is tuned, in this case 60 cycles. Thus the pilot tone does not appear at the grid of V2. The a.f. is amplified by V2 and may be taken off at B.

Note that a.f. is also taken off at the cathode of V2. It is fed back degeneratively to V1. This weakens the a.f., so very little audio appears at point A. The pilot tone is not fed back, so full output appears at A.

**MEASURING DISPLACEMENT**

Patent No. 2,596,531

Howard F. Clarke, Pullman, Wash.

(Assigned to United States of America as represented by the U. S. Atomic Energy Commission)

This instrument measures displacement (or vibration) accurately. The vibrating element is coupled only through an electromagnetic field. Therefore the element is not loaded down during a measurement.

A microwave generator feeds energy into a waveguide. The u.h.f. is modulated by a square-wave generator. The microwaves are attenuated and fed into a "magic-tee" bridge. This bridge balances when its right and left arms have the same impedances. In that case there is no output. The left arm contains a tuned element. It is adjusted for zero bridge output with the vibrating element in neutral position.

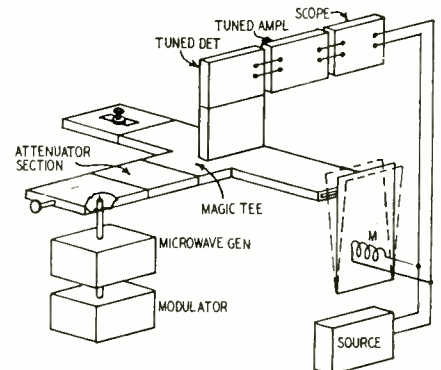

When the vibrating element is displaced in either direction, there is a change in the reflected energy in the right-hand arm. The bridge is unbalanced and output appears. The microwave energy is detected and amplified (at the square-wave frequency). This low-frequency signal is fed to an oscilloscope. For convenience, the displacement or vibration is effected by magnet M energized from the line. The line also sweeps the scope, so its pattern remains stationary.

**IMPROVED  
SCINTILLATION COUNTER**

Patent No. 2,590,867

Harmut P. Kallman, Bellaire, N. Y.

(Assigned to United States of America as represented by the Secretary of the Army)

This invention using stibene crystals cancels out noise in scintillation counters. These crystals give off flashes of light when bombarded with nuclear particles. A multiplier photocell converts the flashes to pulses of voltage. Thus we can tell the strength of radiation by counting the pulses. Unfortunately, we cannot distinguish between noise voltages in the multiplier cell and the voltage pulses produced by the flashes of light. By eliminating the noise we obtain a more accurate count.

The scintillation crystal is ground in the shape of a triangle. In a radioactive field, flashes will

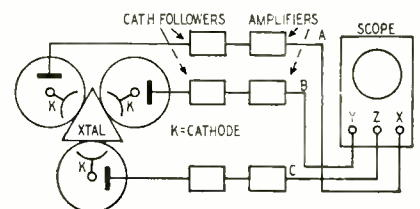



# SAVE \$50. on this Brand New 1953 SUPER-POWER TV CHASSIS

FOR CUSTOM INSTALLATION IN YOUR OWN BOOKCASE, WALL OR CABINET. RMA Guaranteed—Factory Wired

directly adaptable for color and UHF

The first time! 1953 New design Super-Cascade TV Chassis model 620. The ideal companion model for the famous 630 DX-Chassis.

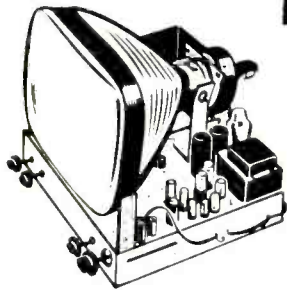

**NEW!**  
**NEW!**  
**NEW!**  
**NEW!**

- Super-Cascade standard coil tuner for longer range and greater sensitivity; doubly shielded to prevent interference and radiation.
- Auto-Stable synchronized circuits to give a perfectly stable picture even in fringe areas and under all conditions.
- Low-Noise hi-filter IF system to widen the band width and produce the ultimate in picture quality.
- Local-fringe switch to increase sensitivity for ideal fringe area reception.

Now! **\$123.50** Complete (less CRT)

This new chassis incorporates all the new advances in TV that have been developed in the largest research laboratories and in various test homes.

**COMPARE THESE INVALUABLE FEATURES!**

- Super-cascade turret tuner: 12 channels may be converted to UHF in 10 seconds.
- Fast action automatic gain control to eliminate outside interference & simplify tuning.
- Hi-voltage section protected by fuse.
- Cosine yoke for edge to edge focus with perfect linearity.
- Increased hi-voltage for better daylight viewing.
- Increased sensitivity in fringe areas by using special new local-fringe switch.
- Large, heavy magnet Alnico V PM speaker.
- Front & rear mounting brackets for all tubes.
- Finest quality, standard components used throughout.
- Chassis comes complete with plugs & sockets for yoke, focus coil & speaker—ready to play. Connect antenna—turn it on!

**EXTRA SAVINGS! Complete Combinations!**

- 620 Chassis plus 17" picture tube **\$144.50**
- #620 Chassis & 17" tube & table model cabinet, a complete TV set **154.50**
- 620 Chassis & 17" tube & console cabinet, a complete TV set **169.50**
- 620 Chassis plus 20" picture tube **154.50**
- #620 Chassis & 20" tube & table model cabinet, a complete TV set **179.50**
- #620 Chassis & 20" tube & console cabinet, a complete TV set **194.50**
- 620 Chassis plus 21" picture tube **159.50**
- 620 Chassis & 21" tube & full size decorator cabinet with 3/4 doors, a complete TV set **229.50**

Above combinations include mahogany cabinets and are completely assembled—ready to give you endless hours of pleasure and entertainment!

FREE! New TV trouble shooting book with each chassis.

Save up to \$50 on these Decorator TV Cabinets



Model 100: Original list, \$79.95. Now only **\$38.50**

Model 200: Original list, \$99.95. Reduced to **\$45.50**. Blotie finish, add \$10.

For 17", 19", 20" & 21" Picture Tubes—630 or other Chassis. Every beautiful cabinet is richly finished with hand rubbed mahogany and made by our own cabinetmakers. They are custom styled, guaranteed new & perfect. Includes safety glass, mesh & mounting brackets. Cabinets are also available with blank control panel to fit any chassis.

**630-DX Chassis**

With new Cascade tuner, 3i-tubes, for 16" to 24" picture tube. Adaptable for color and UHF.

RMA Guaranteed, Factory wired, tested and ready to play. Includes 12" speaker, hardware and knobs.

FREE! New trouble shooting book with every chassis!

Universal Mounting Brackets \$5.95

For extra long range and finest reception up to 200 miles without a booster! Can't be beat for price or quality.

**\$144.50** (incl. Fed Tax, less CRT)



**SPEAKERS** New Low Prices! All Alnico V

- 4" PM ea. \$1.29
- 5" PM 1.39
- 6" PM 1.69
- 4" x 6" PM 1.49
- 8" PM 3.95
- 12" PM 5.95
- 6" 62 ohm double duty with output trans. 2.75
- 4" x 6" 1500 ohm with output trans. 2.75
- 12" 2500 ohm 3.95

Add Dividends!

DEDUCT 10c from the price of any speaker in lots of 10 or more—may be assorted.

SAVE PLENTY—ORDER MANY!

**CONVERT YOUR OLD TV SET TO 17", 20", 21" or 24" PICTURE TUBE.**

Complete conversion kit to match your set! Wonderful new kit comes complete with all parts and diagrams necessary to easily convert any set to larger tube size. Kit includes:

- 70" Cosine yoke
- Matched hi-voltage transformer
- Width coil
- 20,000 V. condenser
- Kit of resistors
- Diagram of instructions

Dealer **\$9.95** Net:

Complete Kit. Be sure to send us make & model of your set for matching conversion kit.

**Great Savings on Nationally Known PHONOGRAPHS**

Guaranteed, Brand New, Sealed Cartons

2-Watt powerful amplifier, 115 V. AC, Alnico V PM Speaker, volume control & switch; heavy duty constant speed motor, shock-proof, covered in beautiful simulated leather.

- Single speed: Lots \$12.95
- 3:95 ea. of 3: ea.
- 3-Speed: Lots \$16.50
- \$17.95 ea. of 3: ea.

3-Speed with VM Automatic Changer, plays all size records: Lots \$42.50 ea. \$46.95 ea. of 3: ea.

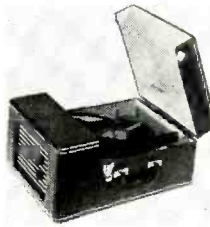

**New Reduced TV PICTURE TUBES**

Full Year Guarantee—Non-glare—Black Face—Brand New—Standard Brands—Sealed Cartons

10B4 Round Glass \$19.95	16K4 Rect. Glass \$24.95
12L4 Round Glass 22.95	17B4 Rect. Glass 23.95
14E4 Rect. Glass 23.95	19AP4 Round Metal 33.95
16A4 Round Metal 36.95	20CP4 Rect. Glass 34.95
16GP4 Round Metal 28.95	21EP4 Rect. Cyl. face 36.95
16MP4 Round Glass 32.95	24AP4 Round Metal 63.95

Never before have we been able to sell these tubes at such low prices—order now!

**Genuine MOLDED CONDENSERS**

Fresh Stock! All mineral oil filled—Fully molded—100 Centigrade—Meets Jan. C91 tests—GUARANTEED

All 600 Volts		All 600 Volts	
Cap.	per 10	per 100	per 100
.001	\$.79	\$6.90	\$.01
.002	.79	6.00	.02
.005	.79	6.90	.05
			1.25

May be assorted in 100 lots

**5-TUBE, AC/DC RADIO SUPERHET**

Table model radio of famous make with illuminated dial, glistening plastic cabinet, automatic volume control. Licensed by RCA. 5-Tubes, incl. rect. AC DC superhet. circuit Alnico V speaker 540 to 1650 KC (560 to 182 meters) 6 tuned circuits Built-in loop antenna Dealer Net: \$15.95 ea. \$14.95 ea.

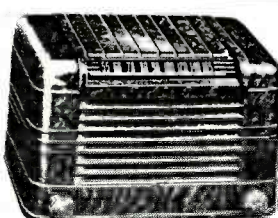

**D.P.D.T. SWITCH** For Hi-Lo frequency antennas. Special close-out price: 39c ea.

box of 10 **29c** ea.

TODAY! Write for new fall catalog with hundreds of savings—tubes, parts, accessories for TV and radio, also test equipment.

**Rose Co.'s ANTENNA KIT Saves you many dollars!**

New antenna kits contain everything needed for a complete safe-factory installation. NOW is the time to purchase these add extra worth out antennas with these brand new aluminum jobs. Be ready for the millions of dollars of TV entertainment scheduled for '53. Don't miss a single show because of poor reception!

No. K-21 KIT includes: 1—8 element antenna 75 ft. highest quality 300 ohm wire 2—5 ft. 1 1/2" steel mast sections 2—mast stand-off insulators 4 screw-eye shackoffs 1 all-angle base unit 1 U.T. approved lightning arrester

Save! Dealer **\$6.99** Net:

No. K-22 KIT includes: Same as K-21 except that it includes 2-8 element covered antennas and 1 set of stacking bars.

Terrific Buy! Dealer **\$9.99** Net:

No. K-31 KIT includes: Same as K-21 (above) except that it includes a new single pre-assembled super-fan conical antenna. Finest conical ever made.

Great Value! Dealer **\$10.99** Net:

No. K-32 KIT includes: Same as K-31 (above) except that it includes 2 supporting conical antennas and one set of stacking bars.

Best Buy! Dealer **\$14.99** Net:

**Tubes** BRAND NEW, STANDARD BRANDS, FULLY GUARANTEED, INDIVIDUALLY BOXED

0Z4	\$.55	6BN6	\$.99	12A6	\$.59
1B3	\$.89	6BQ6	\$.99	12AU7	\$.89
1X2A	\$.89	6CB6	\$.75	12AT7	\$.99
5U4	\$.65	6F8	\$.99	12BH7	1.10
6AG5	\$.80	6L6GA	1.35	25B6	\$.99
6AL5	\$.60	6J6	\$.85	25L6	\$.60
6AQ5	\$.65	6SA7	\$.60	35L6	\$.63
6AU6	\$.60	6SN7	\$.82	35W4	\$.44
6BC5	\$.75	6T8	\$.79	3Z5Z	\$.47
6BG6	1.79	6V6	\$.65	39/44	\$.49
6BL7	1.10	6W4	\$.60	50L6	\$.63

All other Tubes in Stock

MIN. ORDER: \$5.00. 25% with order, balance C.O.D. include postage with order. All merchandise subject to prior sale. Prices subject to change without notice. FOB New York City.

100 Park Place—Dept. E-10—New York 7, N. Y. COrtlandt 7-6195.

**ELECTROLYTIC CONDENSERS** LOWEST PRICE WE KNOW

Mfd.	ea.	Lots of 10	Lots of 100
20/20-150 V.	39c	\$3.50	\$33.95
40/40-150 V.	45c	3.95	37.95
50/30-150 V.	45c	3.95	37.95
50/50-150 V.	49c	4.39	39.95
40/40/20-150 V.	49c	4.49	37.95
50/30/20-150 V.	49c	6.49	37.95
50/50 x 200 150 V.-25 V.	79c	7.49	67.95
25-25 V.	19c	1.50	13.50
25-50 V.	19c	1.50	13.50
20-150 V.	29c	2.59	23.95
40-150 V.	29c	2.59	23.95
8-450 V.	39c	3.59	29.95
10-450 V.	39c	3.59	29.95
14-450 V.	39c	4.95	47.95
30-450 V.	59c	4.95	47.95

**THE ROSE COMPANY**

show at each face of the crystal. These fall on separate photomultiplier tubes. For convenience we show only a cathode and collector in each tube. The three pulse outputs follow separate paths: A, B, and C. Each circuit includes a cathode follower for isolation and an amplifier.

Pulses from A, B, and C are tied to the X, Y, and Z (horizontal, vertical, and blanking) terminals, respectively. The beam is set just below visibility. Pulses from C feed the amplifier so the beam becomes visible. When 3 pulses arrive together we see a diagonal trace. If only one or two arrive, we see either a dot or nothing at all.

It is not likely that random noise will occur in all three circuits simultaneously more than once every 16 minutes. Noise is effectively cut out and we are assured an accurate scintillation count.

**D. C. MEASUREMENT**

Patent No. 2,589,494

William D. Hershberger, Princeton, N. J.  
(Assigned to Radio Corp. of America)

This invention is based on the principle of nuclear resonance. It makes possible the accurate measurement of direct current.

Nuclear particles are like gyroscopes. While spinning, they can absorb energy from surrounding magnetic fields and can also radiate. This inventor immersed the nuclei in two fields—one d.c., the other r.f. Nuclear absorption and radiation then occurs at the r.f. rate. This reaction is greatest at a critical ratio of frequency/d.c. field. The most important fact is that nuclear resonance is *ultra-sharp*. It acts like a tuned circuit having a Q of 70,000.

To make a measurement, we may vary either the d.c. field or the r.f. field. When reaction

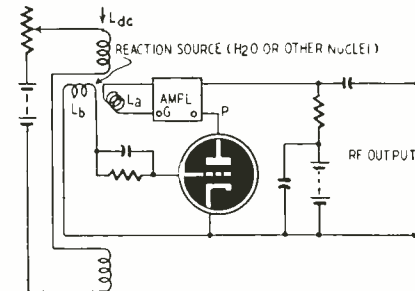

occurs, we know that frequency/d.c. field is at the critical value. If the frequency is known, we can easily find the strength of the d.c. field. For hydrogen nuclei (common protons) the critical value is 4257.76 cycles per gauss.

The figure shows three coils:  $L_{d.c.}$ ,  $L_a$  and  $L_b$ .  $L_{d.c.}$  is placed vertically and is energized from a regulated d.c. source.  $L_a$  is fed by the output of a high-gain r.f. amplifier.  $L_b$  is connected to the input stage of this amplifier. Coils  $L_a$  and  $L_b$  are at right angles to each other, so they are not coupled magnetically. All three coils are placed near a test tube filled with water (which contains hydrogen). Energy absorbed by the hydrogen protons in the field of ( $L_{d.c.}$ ) is radiated and received by the field of  $L_b$ . Thus these coils are coupled only through *nuclear resonance*.

$L_a$  and  $L_b$  are connected like the plate and grid coils of an oscillator. Energy from the first can be fed back to the second. Maximum feedback occurs only at the critical frequency, once the d.c. field is set. For any given value of current in  $L_{d.c.}$  there is a definite output r.f. We can measure the frequency; then by referring to the critical ratio, we find the field about  $L_{d.c.}$ . If the coil is calibrated, the direct current may be known exactly. END

**DOLLAR FOR DOLLAR WE BRING YOU YOUR BEST BUYS IN TV!**

OUR POLICY OF FAIR DEALING — i.e. top quality items supplied *completely* at prices indicated (no extras, no gimmicks, Federal tax included) HAS WON NATIONAL ACCLAIM. CABINETS, supplied to fit the #630 or with blank knob panel for any TV set, any 12 1/2" to 21" CRT cutout, mahogany or walnut, at prices shown.

**SAVE 10%** On a COMBINED PURCHASE of a CHASSIS, any CABINET and any PICTURE TUBE. 10% off the total—Bringing you the world's best TV set at the price of an ordinary set.

**The VOGUE**

Most popular table model and the best value ever!



H-24", W-26", D-23".  
Wgt. 48 lbs.

**\$39.89**

**VOGUE for 24" or 27"**  
H-31", W-27", D-23".

Wgt. 60 lbs. **\$62.54**

**#630 SUPER DELUXE 31-TUBE TV CHASSIS**

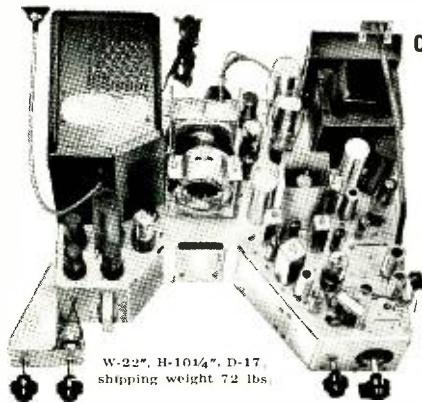

W-22", H-10 1/4", D-17",  
shipping weight 72 lbs.  
**NATIONALLY KNOWN MFR.**  
Licensed under RCA patents

**OPERATES ALL 16" TO 24" PICTURE TUBES**

Engineered in strict adherence to the genuine RCA #630, plus added features ★ ★ ★ ★ ★

**NOTHING BETTER AT ANY PRICE!**

- Standard Cascode Turret Tuner for DX
- Cosine 70° Deflection Yoke for Definition
- Original 630 Synch. Chain for Stability
- 16 KV for Clarity and Brilliance
- Fast Action Pulse Keyed AGC
- Large Concert-tone 12" PM Speaker

**COMPLETE READY TO PLAY \$167.97**  
with all tubes, hardware, universal mounting brackets, etc.  
(less C.R. Tube)

The **MANHATTAN**  
It Has Everything  
Style, Quality, Price



H-11", W-25", D-23".  
Wgt. 36 lbs.

**\$59.37**

**MANHATTAN** 24"-27"  
H-46 1/2", W-27 3/4", D-24".  
Wgt. 78 lbs. **\$86.22**

**FINEST STANDARD GUARANTEED PICTURE TUBES**

Most desirable 4 sizes — Choice of DUMONT or SHELDON each with one full year guarantee

**17" Rect. \$29.63**  
shipping weight 23 lbs.

**20" Rect. \$39.74**  
shipping weight 31 lbs.

**21" Rect. \$44.68**  
shipping weight 38 lbs.

**24" Round \$69.49**  
shipping weight 43 lbs.



**The STREAMLINER**  
Center Drop Panel  
Conceals Tuning Knobs.



H-42", W-26", D-24".  
Wgt. 80 lbs.

**\$74.98**

**The MAYFAIR**  
Smartly modern, elegance  
of simplicity in styling.



H-40", W-27", D-23".  
Wgt. 85 lbs.

**\$98.56**

**The TOWN & COUNTRY**  
Styled as the popular credenza  
special for the 24" or 27" CRT



H-42", W-30", D-24".  
Wgt. 100 lbs.

**\$109.62**

**The PLYMOUTH**  
Interior decorator's choice  
exquisite in every detail.



H-40", W-27", D-23".  
Wgt. 82 lbs.

**\$105.48**

**The NEW YORKER**  
A Deluxe Cabinet  
With a Piano Finish.



H-42", W-26", D-24".  
Wgt. 100 lbs.

**\$96.87**

**BROOKS RADIO & TV CORP., 84 Vesey St., Dept. A, New York 7, N. Y.**

TELEPHONE  
COrtland 7-2359



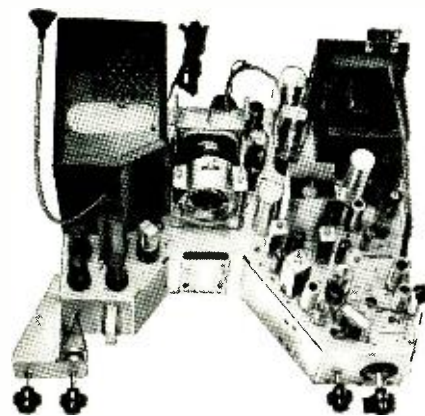

## #630 STANDARD TV KIT

THIS OFFER MAKES TV HISTORY... Never ever so low a price, never ever such high quality... Quality and improvements in components that will enable the finished chassis to operate 10" 12 1/2" and certain 16" picture tubes. This STANDARD KIT consists of a complete set of parts, similar to those used in the famous RCA #630 29-tube chassis, including all tubes, speaker, resistors in correct 5%, 10%, 20% tolerances, the new Cascade tuner and the Brooks LIFE-SIZE Instructions (less CRT & wire)

only... **\$93.78**

## #630 SUPER DELUXE KIT

For the 31-tube CHASSIS that operates all 16" to 24" picture tubes... Tops for fringe areas... Peak performance for clarity, brilliance, stability and definition... This SUPER DELUXE TV KIT consists of a complete set of parts, including the basic components of the STANDARD KIT plus added features, more tubes, doubler components, AGC components, Cascade tuner, Cosine 70° deflection yoke, 12" speaker, etc., and the Brooks LIFE-SIZE Instructions. (less CRT & wire)

only... **\$119.44**

## #630 PARTS • IN SETS

VIDE0 AND I.F. KIT, 19 items.....	\$7.84
AGC KIT, complete with instructions.....	4.59
VARIABLE CONTROL KIT, 9 controls.....	5.83
CARBON RESISTOR KIT, 107 resistors.....	6.98
WIREWOUND RESISTOR KIT, 4 resistors.....	2.31
BACKET AND SHIELD KIT, 18 items.....	8.63
ELECTROLYTIC CONDENSER KIT, 6 cond.....	7.37
TUBULAR CONDENSER KIT, 38 condensers.....	4.28
CERAMIC CONDENSER KIT, 28 condensers.....	3.37
MICA CONDENSER KIT, 11 condensers.....	1.38
COMPLETE SOCKET KIT, 25 sockets.....	1.57
TV WIRE & SOLDER KIT, for any Set.....	1.49

## STANDARD PICTURE TUBES

DuMont or Sheldon With a Full Year Guarantee!

10" — #10BP4A (Round, Black).....	\$18.36
12 1/2" — 12LP4A (Round, Black).....	24.72
14" — 14CP4A (Rectangular, Black) ..	26.48
16" — 16AP4A (Round, Metal, Black) ..	28.97
16" — 16DP4A (Round, Black).....	28.97
16" — 16GP4A (Round, Metal, Black) ..	28.97
16" — 16TP4 (Rectangular, Black) ..	28.97
17" — 17BP4A (Rectangular, Black) ..	29.63
19" — 19AP4A (Round, Metal, Black) ..	34.82
20" — 20CP4A (Rectangular, Black) ..	39.74
21" — 21EP4A (Rectangular, Black) ..	44.68
24" — 24AP4 (Round, Metal, Black) ..	69.49

## SPECIAL #630 TV PACKAGE

Hints for Better Pictures on Your #630 TV  
630 TV Diagram with Modifications All for only  
Illustrated TV Conversion Manual  
Pulse Keyed AGC Circuit Diagram  
RMA Resistor & Mica Code Charts

**\$1.00**  
post-paid

You will also receive our latest catalog and flyers with special offers in TV, Chassis, Cabinets, Picture Tubes, Parts, Radios, Portables, Auto Radios, Radio Tubes, Test Equipment, Accessories, Etc., at WHOLE-SALE PRICES.

## BROOKS RADIO & TV CORP.

84 Vesey St., Dept. A, New York 7, N. Y.

OCTOBER, 1952

# Brooks LIFE-SIZE Edition

## #630 TV KIT BUILDER - SET OF INSTRUCTIONS

Simplifies BUILDING any #630 **\$2.49** postpaid A Television Course in Itself!

## COMPLETE PARTS LISTING FOR ALL #630 TV SETS

Comprises set of parts for the original #630 STANDARD or the SUPER DELUXE.

Parentheses indicate amounts of parts needed in lots of two or over.

\*s Indicate alternate or extra parts needed for the SUPER DELUXE or AGC.

STANDARD CASCODE TUNER, incl. tubes	\$22.49	PUNCHED CHASSIS PAN, cadmium plated	\$4.87
ESCUTCHEON PLATE, for tuner.....	.69	630-KIT, screws, nuts, rivets, washers.....	1.69
COMPLETE SET OF KNOBS, incl. decals.....	1.34	HI VOLTAGE CAGE ASSEMBLY, complete	3.73
POWER TRANSFORMER, 295ma. 201T6.....	9.97	VOLTAGE DIVIDER SHIELD & COVER ..	1.79
VERTICAL OUTPUT TRANS. 204T2.....	2.69	ELECTROLYTIC COND. SUB-CHASSIS.....	.94
VERTICAL BLOCKING TRANS. 208T2.....	1.32	SOUND DISCRIMINATOR SHIELD.....	.19
HORIZONTAL OUTPUT TRANS. 211T1.....	2.47	DEFLECTION YOKE BRACKET.....	.29
*HORIZONTAL OUTPUT TRANS. 211T5.....	3.98	DEFLECTION YOKE MOUNTING HOOD.....	.59
* FOCUS COIL, 247 ohms. 202D1.....	2.29	FOCUS COIL BRACKETS.....set	.49
* FOCUS COIL, 470 ohms. 201D1.....	3.42	CATHODE TRAP COIL SHIELD.....	.39
DEFLECTION YOKE, 60° 201D1.....	2.97	CHASSIS MOUNTING BRACKETS, set of 4	.44
* DEFLECTION YOKE, Cosine 70° 206D1.....	3.98	BRIGHTNESS & HOLD CONTROL BRACKET	.59
SOUND DISCRIMINATOR TRANS. 203K1.....	1.12	WIDTH CONTROL BRACKET.....	.16
1st PIX I.F. TRANSFORMER. 202K2.....	1.08	TUNER SHAFT BRACKET.....	.17
2nd PIX I.F. TRANSFORMER. 202K3.....	1.08	* FUSE (.25 amp.) & HOLDER.....	.24
1st & 2nd SOUND I.F. TRANS. (2) 201K1 each	1.02	HY RECTIFIER, SOCKET ASSEMBLY, single	.79
HORIZONTAL DISCRIM. TRANS. 208T8.....	1.49	* HY RECTIFIER, SOCKET ASSEMBLY, double	1.37
FILTER CHOKE, 62 ohms.....	1.47	TV 6' LINE COIL, with both plugs.....	.29
CATHODE TRAP COIL..... 202K4.....	1.08	INTERLOCK SAFETY CONNECTOR (input)	.17
WIDTH CONTROL COIL..... 201R1.....	.44	COMPLETE TERMINAL STRIP KIT, set of 30	.98
* WIDTH CONTROL COIL, keyed AGC IR4AG	.79	TUBE SHIELD & CLIP.....2 sets	.22
HORIZONTAL LINEARITY COIL. 201R3.....	.39	* AGC BRACKET & SOCKET.....	.39
3rd & 4th PIX COILS, (2) 202L1 each	.39	MINIATURE WAFER SOCKETS (10), each	.07
FILAMENT CHOKES, (5) 204L1 each	.09	MINIATURE MOLDED SOCKETS (2), each	.12
VIDEO PEAKING COIL. 203L1.....	.18	OCTAL WAFER SOCKETS (13),.....each	.07
VIDEO PEAKING COIL. 203L2.....	.18	CATHODE RAY TUBE SOCKET, 18" leads.	.39
VIDEO PEAKING COILS, (2) 203L3 each	.18	HY KINESCOPE LEAD, with clip.....	.39
VIDEO PEAKING COILS, (2) 203L4 each	.18	AUDIO OUTPUT TRANSFORMER (6K6).....	.69
ION TRAP BEAM BENDER, double 203D3.....	.98	8" PM SPEAKER, heavy alnico #5 magnet	3.97
* ION TRAP BEAM BENDER, single 203D1.....	.79	* 12" PM SPEAKER, heavy alnico #5 magnet	6.94

### VARIABLE CONTROLS

PICTURE & SOUND, 10k ohms 1 meg. & switch	1.14
VERTICAL & HORIZ. 50k ohms 1 meg.....	1.04
BRIGHTNESS CONTROL, 50k ohms.....	.44
HORIZ. CENTERING, wirewound 20 ohms.....	.57
HEIGHT CONTROL, 2.5 megohms.....	.48
VERTICAL LINEARITY, 5000 ohms.....	.44
VERTICAL CENTERING, wirewound, 20 ohms.	.96
FOCUS CONTROL, wirewound, 1500 ohms.....	.98
HORIZONTAL DRIVE, 20k ohms.....	.44
* HORIZONTAL TRIMMER, 40-103 mmf.....	.39

### WIREWOUND RESISTORS

5000 ohms, 5 watts.....	.22
* 5000 ohms, 5 watts (2).....	.22
VOLTAGE DIVIDER, 1360/250 ohms.....	.74
VOLTAGE DIVIDER, 5300/2-500 ohms.....	.89
VOLTAGE DIVIDER, 6750/12/93 ohms.....	.72

### MICA CONDENSERS—85°C Operation

270 mmf — 500 v. (7).....	each .12
390 mmf — 500 v.....	.12
470 mmf — 500 v.....	.12
680 mmf — 500 v.....	.16
4700 mmf — 500 v.....	.29
* 2200 mmf — 1500 v.....	.29

### ELECTROLYTIC CONDENSERS—85°C

40/10/80 mfd — 450/450/150 v.....	1.37
40/40/10 mfd — 450/450/450 v.....	1.49
80/50 mfd — 450/50 v.....	1.49
40/10/10 mfd — 450/450/350 v.....	1.37
20/80 mfd — 450/350 v.....	1.49
250/1000 mfd — 10/6 v.....	.98

### TUBULAR CONDENSERS—85°C

.005 — 400v (3) ea.....	.07	.01 — 600v (2) ea.....	.12
.01 — 400v (5) ea.....	.09	.05 — 600v (6) ea.....	.15
.015 — 400v (2) ea.....	.11	*.05 — 600v.....	.15
.05 — 400v (5) ea.....	.12	.1 — 600v.....	.17
.1 — 400v (2) ea.....	.14	.001 — 1000v.....	.14
.25 — 400v (2) ea.....	.21	.004 — 1000v (2) ea.....	.14
.002 — 600v.....	.09	.035 — 1000v.....	.18
.0025 — 600v (2) ea.....	.09	.05 — 1000v.....	.18
.004 — 600v.....	.11	*.1 — 1000v.....	.22
.005 — 600v.....	.11	*.5 — 200v.....	.24

### CERAMIC CONDENSERS

10 mmf 10% Tolerance.....	.12
51 mmf 10% Tolerance.....	.12
56 mmf 10% Tolerance.....	.12
82 mmf 10% Tolerance.....	.12
82 mmf 10% Tolerance (2).....	each .12
1200 mmf not less than rated capacity.....	.14
1500 mmf not less than rated capacity (21) ea.	.14
6800 mmf not less than rated capacity.....	.19
* AGC RESISTORS & MICA.....	set of 7 .74

### H. V. FILTER CONDENSERS—(Cartwheels)

15kv — 500 mmf.....	.67
* 20kv — 500 mmf.....(3) each	.79

### CARBON RESISTORS

1/2 WATT, 5% TOLERANCE, 10, 3900, 4700, 5600, 10k(2), 18k, 680k(2), 820k OHMS, 1.2, 1.5 MEG.....	each .09
1/2 WATT, 10% TOL., 3.3 39(3), 330 560, 680, 800, 2700(2), 3300, 4700, 6800(4), 8200(4), 10k(4), 22k, 27k(2), 47k, 56k, 100k(3), 150k, 270k 470k(3) OHMS, 1(2), 2.2(2) 4.7, 6.8 MEG	each .07
* 3.3, 47, 390k OHMS.....	each .07
1/2 WATT, 20% TOL., 100(3), 150(5), 1000(8), 3300 22k(3), 150k, 220k(2), 330k, 470k(3) OHMS, 1(3), 10 MEG	each .05
* 220k OHMS.....	each .05
1 WATT, 5% TOL., 2.2, 39k, 47k OHMS each	.14
1 WATT, 10% TOL., 1800, 3300, 4700(2), 10k(2), 18k, 22k, 27k, 39k, OHMS, 1 MEG	each .12
* 18k OHMS (in series) in sleeves.....	set .58
4-470k OHMS (in series) in sleeves.....	set .58
1 WATT, 20% TOL., 1000, 10k OHMS	each .10
* 470k OHMS.....	each .10
2 WATT, 10% TOL., 100, 270 OHMS.....	each .18
2 WATT, 20% TOL., 2200(2) OHMS.....	each .14

### #630 TV TUBES—STANDARD MAKES

6AG5..... R. F. Amplifier.....	1.27
6J6..... R. F. Oscillator & Converter.....	1.39
6BA6..... 1st and 2nd Sound I.F. (2).....	each .84
6AU6..... 3rd Sound I.F. (2).....	each .84
6AL5..... Sound Discriminator.....	.94
6AT6..... 1st A.F. Amplifier.....	.69
6K6GT..... Audio Output.....	.77
6AG5..... 1st, 2nd, 3rd, 4th Pix I.F. (4) each	1.27
6AL5..... Pix, Det. & DC restorer.....	.94
6AU6..... 2nd Video Amplifier.....	.84
6K6GT..... 1st Video Amplifier.....	.77
6SK7..... 1st Sync. Amplifier.....	.84
6SH7..... Sync. Separator.....	1.04
6SN7..... 2nd Sync. Amp & Hor. & D's.....	1.04
6J5..... Ver. sweep osc. dis.....	.69
6K6GT..... Vertical sweep output.....	.77
6AL5..... Hor. Sync. Discriminator.....	.94
6K6GT..... Hor. Sweep Oscillator.....	.77
6AC7..... Hor. Sweep Osc. Control.....	1.39
6BG6G..... Horizontal Sweep Output.....	2.32
5V4G..... Reaction scanning.....	1.14
1B3..... High Voltage Rectifier.....	1.27
5U4G..... Power Supply Rectifier (2).....	each .69
* 1B3..... High Voltage Rectifier.....	1.27
* 6AU6..... Keyed AGC.....	each .84
C.R. Tube.. Optional	

# Sensational TV BARGAINS!

**FREE**

With Each order of \$10 or more received on or before October 31, you will receive our Rocket 7 Ft. Interlock Line Cord. Permits adjustment, testing, repair of set while operating with back removed. When ordering, state that you want this gift. Don't delay as quantities are limited. Only one given to a customer.

**AMAZING 360° ALL CHANNEL RECEPTION**

- 360° Electronically Switched Beam
- No Motors
- No Roof Orientation
- No Electric Power
- No Ghosts
- Flick of Switch Clears Picture Instantly

with the Famous **Rocket DIRECTRONIC**

**MOTORLESS TV ANTENNA**

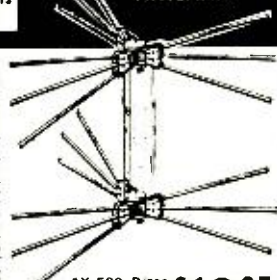

Provides same clear pictures as rotating aerials costing 4 times as much. Electronically beams in all directions with full 360° rotation. You select direction with Directronic Beam Selector located at set. Model AX-59 stacked array includes 18 bifurcated aluminum elements, 1 set connecting stubs, Universal U-Clamps for mast, Directronic Beam Switch, and 7 feet of TFL-X lead-in. Model AX-59 Directronic-9-element Single.....\$10.35

AX-599 Directronic, As shown.....\$16.95

## ROCKET 8 ELEMENT YAGI

Super-Powered Fringe Reception



Designed for clear pictures in urban fringe and other areas where signal is weak. Highly directional—engineered for maximum reception on each channel. Pre-assembled for quick rig. Eight bifurcated elements include one folded dipole, 6 directors, and 1 reflector. Less mast.

Channels 7-13... \$7.95  
 " 4, 5, or 6... \$12.95  
 " 2 or 3... \$15.95

## Rocket 5-Element Yagi



Excellent Pictures in Medium Fringe Areas  
 Designed for high gain with minimum interference from ghosts and noise due to directive pattern. Produces clear sharp pictures. 5 heavy aluminum elements include one folded dipole, one reflector, three directors. Strong molded insulator. Non-slip mast clamp. Completely pre-assembled. Less mast.

Channels 2 or 3.....\$7.95 ea. 4, 5, or 6.....\$6.95  
 Channels 7 to 13.....\$3.95

When ordering specify exact channel number desired.

## ALL CHANNEL CONICALS

Single Bay (8 elements).....\$3.65  
 Stacked array with tie rods (16 elements).....7.95

## Rocket 35-foot Mast Kit

Economy mast kit contains 3-10' seamless duralcated 1 1/4" O.D. masts, one 5' mast, 300 feet of 6/20 galvanized steel guy wire, and everything else needed including guy rings, mast connectors, insulators, cable clamps, guy hooks, and swivel mounting base.  
 Rocket 35' mast kit.....ONLY \$12.95  
 Rocket 25' mast kit.....ONLY \$9.95

## LOWEST PRICES ON ANTENNA ACCESSORIES

Mast Steel (Duralcated 5' crimped) 1 1/4" O.D.....\$1.05  
 Mast Steel (Duralcated 10' 1 1/4" O.D.....1.95  
 Mast Connectors for 1 1/4" O.D. mast......59  
 Chimney Mount Complete with Straps.....1.19  
 Peak Roof Saddle (will take up to 1 1/2" O.D.).....1.59  
 Lightning Arrestor-TV......69  
 Galvanized Steel Guy Wire-6/20.....34c ft.  
 Galvanized Steel Guy Wire-11/20.....1 1/2c ft.  
 Rocket Twin-Lead-7/28 stranded......2c ft.  
 Rocket Open Line Twin-Lead (500' reel).....19.95  
 Mast Stand-off Insulators-3"......11  
 Stand-off Screw Insulators-3"......03  
 Wall Bracket-6" clearance......49  
 12" Clearance.....2.49

ALL PRICES F.O.B. CLEVELAND, OHIO. Do not remit more than complete purchase price. Pay shipping charges on receipt of goods. 25¢ deposit on C.O.D. orders, please. Money-back guarantee.

Catalog Available upon Request

**National Electronics**  
 OF CLEVELAND  
**THE HOUSE OF TV VALUES**  
 210 Delco Building, Cleveland 3, Ohio

## HIGH-RESISTANCE TESTS

In some experimental work, it is necessary to measure very high resistances such as the leakage resistance of a capacitor or the insulation resistance of a length of cable or a tube socket. Such resistances are beyond the range of conventional ohmmeters but they can be easily measured by using the R-C oscillator technique where the unknown resistance is the R component.

The diagram shows a neon-tube relaxation oscillator with the components

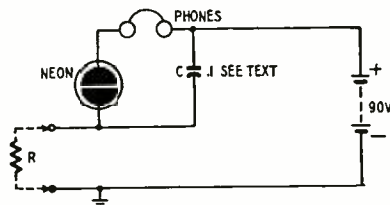

juggled so the resistance is at ground potential. C is chosen to give a low oscillation frequency. A value of 0.1 μf is suitable for resistances in the range of 10 to 100 megohms. Connect the unknown resistance to the terminals and count the clicks produced in a convenient interval of time; say one minute. From this, calculate the average time between clicks. Call this time t. The resistance is given by the formula  $R = t/C$  where R is in megohms, t is in seconds, and C is in microfarads. This will not give the exact value of the resistance but it will be close enough for most purposes.—Charles Erwin Cohn

## COVERS FOR R.F. CHOKES

Small pie-wound r.f. chokes and coils are very delicate and easily damaged. We must be always on the alert to avoid touching the winding with a hot soldering iron and to prevent stray bits of solder or metal filings from becoming imbedded between the turns and eventually causing a short or open circuit. Plastic bottle caps come in a

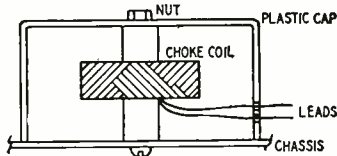

variety of shapes and sizes and it is not hard to find one that will make a good protective shell for that small choke or coil. Drill two small holes in the side of the cap for the leads, then mount the cap by running a bolt through a hole in its top and the core of the choke as shown in the drawing.—B. W. Welz

## IMPROVING A.V.C. ACTION

In many receivers, the tubes controlled by a.v.c. have their screens fed through dropping resistors connected to the B plus line. This connection reduces the effectiveness of the a.v.c. system. When the a.v.c. voltage rises—becomes more negative—the screen current drops and screen voltage rises. The

## \$3.00 FOR CARTOON IDEAS

RADIO-ELECTRONICS prints several radio cartoons every month. Readers are invited to contribute humorous radio ideas which can be used in cartoon form. It is not necessary that you draw a sketch, unless you wish.

Address  
**RADIO-CARTOONS,**  
**RADIO-ELECTRONICS**  
 25 West Broadway,  
 New York 7, N. Y.

## ENGINEERS



Make this your home for important work under ideal conditions

- TV Receiver Design Eng.
- Test & Inspection Eng.
- Electronics Eng.
- Field Engineers
- Lab Technicians

## TO WORK ON:

Radar, G. C. A., Mobile Radio, Auto Radio, Airborne Communication & Navigation Equipment, Television, Antennas, Microwave Equipment, Servo Mechanisms, Guided Missiles and Test Equipment.

## YOU BENEFIT

from high wages, a modern, air-conditioned plant, paid vacations and holidays, group insurance and a good chance for advancement. Housing immediately available in the beautiful suburban and country areas that surround the Bendix plant.

Write  
 Wire,  
 Phone  
 Mr. E. O.  
 Cole,  
 Dept. 5

# Bendix Radio

DIVISION OF BENDIX AVIATION CORP.  
 BALTIMORE-4, MD. Phone: TOWSON 2200



**TOP-SELLING TV-RADIO PUBLICATIONS** distributed by HOWARD W. SAMS & CO., INC.

**COYNE**

**FAMOUS SHOP-TESTED REFERENCE BOOKS**

**"Latest Testing Instruments for Servicing Radio-TV"**

New 1952 edition tells all about modern electronic testing equipment and how to use it most effectively. Packed with money-making short-cuts on trouble-shooting, servicing, construction and other subjects involving use of test instruments. Covers Multipliers, Resistors, Ohmmeters, Oscilloscopes, etc. All data shop-tested for practical application. Profusely illustrated, 350 pages. ORDER CTB-3. Only.....\$3.25



**"TV Servicing Cyclopedia"—A Best Seller**

The fact-packed TV reference book by H. P. Manly. Covers every phase of TV, including latest data on color and UHF. Shows you how TV works, how to service sets. Special sections on picture pattern servicing; testing and measuring; alignment; full treatment of amplifiers, antennas, controls, ion traps, sync. circuits, power supplies, video IF amplifiers, sweep oscillators, adapters, converters—covers everything. 750 pages. ORDER CTB-1. Only.....\$5.95



**"Television and Radio Handbook"**

1952 edition of the famous TV and radio "answer" book. Over 3000 facts packed into a single volume to speed trouble-shooting. Covers solutions to most frequent TV-radio service troubles; offers short-cut time-saving tips; data on TV boosters, latest UHF conversion methods, etc. 375 pages, hundreds of illustrations. ORDER CTB-5. Only.....\$2.75



**BOYCE**

**AUTHORITATIVE TV & RADIO HANDBOOKS**

**"Video Handbook"**

Covers entire subject of TV; gives expert data on design, construction, operation and servicing. Fourteen complete sections cover the field of TV exhaustively. All subjects treated practically and simply for easy understanding. A remarkable handbook widely used by schools, engineers, experimenters, and industrial technicians. 892 pages. ORDER BB-2. Only.....\$5.95



**"Radio and Electronics Handbook"**

Here is the basic knowledge and data of Radio and Electronics digested in 18 sections; complete, easy-to-locate data. Clearly explains radio and electronic theory, and covers all phases of the subject in detail. The most widely used handbook of its kind—absolutely invaluable to anyone interested in radio or electronics. 890 pages; illustrated. ORDER BB-1. Only.....\$4.95



**HOWARD W. SAMS & CO., INC.**

Order from your Parts Jobber today, or write direct to Howard W. Sams & Co., Inc. 2205 East 46th St., Indianapolis 5, Ind.

\$.....enclosed. Send the following books:  
 CTB-3     CTB-1     CTB-5  
 BB-2     BB-1

Name.....  
 Address.....  
 City.....Zone.....State.....

increased screen voltage tends to increase the gain of the stage and cancels a part of the gain reduction due to a.v.c. action.

It is better to feed the screens from a tap on a heavy voltage divider. The screen voltage remains constant and the improvement in a.v.c. action is quite noticeable. Only one-half the previous a.v.c. voltage is needed for the same decrease in gain.—Charles Erwin Cohn

**POWER SUPPLY SWITCHING**

When developing or experimenting with receivers, amplifiers, and the like, we often desire to adjust or work on the circuit as soon as the power is turned off. If we do, we run the risk of damaging our multimeters or receiving a serious shock from the charge remaining on the filter capacitors. Therefore, it is desirable to rapidly discharge the filters as soon as the power is turned off. A heavy bleeder will do this but it consumes power while the supply is turned on.

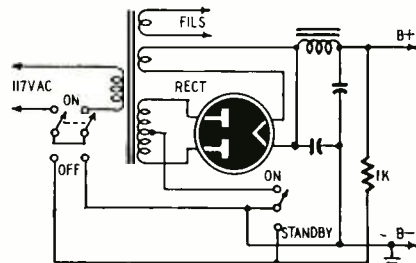

The diagram shows a simple power supply with a.c. and stand-by switches arranged to discharge the filter capacitors when either is turned off. The 1,000-ohm resistor limits the current through the switch contacts as the capacitors are shorted out.—J. Sareda

**SIMPLE A.F. OSCILLATOR**

While working on a project late one evening, we found that we needed a neon tube for a relaxation type a.f. oscillator to complete the job. The stores were closed and we didn't have a neon lamp, so we substituted a fluorescent lamp starter. The starter was opened and the capacitor was removed from across the small neon tube. A capacitor of 10-50 µf was connected across the tube and a resistance of three megohms was connected between one side of the lamp and a source of 90-135 volts d.c. (See diagram.) The audio signal is taken from across the resistor through a .01-µf blocking capacitor and may be fed to a key and headphones for code practice, to the modulation jacks of an r.f. oscillator, or to the input of an audio amplifier being tested. The pitch of the note can be changed by varying the capacitance or resistance in the circuit.—G. J. Macheak

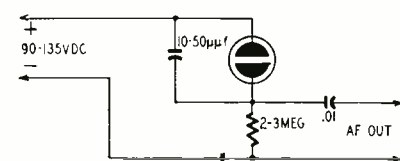

**TV PROBLEMS? GRAYBURNE gives you EFFECTIVE answers!**



**TV-IF SIGNAL BOOSTER**

An added stage of TV-IF wired up in Adaptor form. Produces excellent results in near-fringe areas and where a modest gain is required.

- Overcomes roof antenna restrictions
- Amplifies signal over 20% on all channels
- Eliminates or minimizes "snow"
- No switches or external connections
- Simple, permanent, easy installation inside cabinet

Write for free Technical Bulletin "Plug-In TV Booster" by Jack Grand. Model TS8-1 List \$995, plus extra tube required.

**CLEAR-PIX TV INTERFERENCE FILTERS**

4 Popular, Fast-Selling Models—reject 4 most common interference causes.

Incorporate scientifically designed and proved circuits. Have high rejection efficiency. Extremely simple to install—less than one minute.

Model #	Interference Rejected
CPF	FM
CPD	Dialtherapy
CPI	Ignition
CPH	Amateur (21 mc)

Low Cost: List \$198 each.

**DUAL TUNABLE TV INTERFERENCE FILTERS**

for Professional Installations and where Interference is intense.

Precision-engineered. Incorporate a dual set of coils and condensers center-tapped to ground for greater efficiency. Very easy to install and balance.

Model #	Interference Rejected
SW-10	10 meter band
SW-20	20 meter band
DT	Dialtherapy
FM	FM

List \$275 each

**BE PREPARED!** Keep 1 of each type of Filter in your Tool Kit at all times!

For complete Grayburne Catalog and name of your nearest distributor, write NOW to Dept. G.



**GRAYBURNE CORPORATION**  
 103 Lafayette Street, New York 13, N. Y.

## PRECISION RESISTOR KINK

Ordinary composition carbon resistors can be used instead of expensive precision units in step attenuators, R-C oscillators, meter multipliers, etc. They will hold their resistance within 1% if you take two precautions: (1) Limit the voltage drop, and the power actually dissipated in each resistor to not more than 10% of its commercial ratings. (2) Use special care not to overheat the body of the resistor while soldering it in the circuit.

In 1943 I constructed step attenuators from standard 1/4-watt resistors checked on a bridge to within 1% of the desired values. Four years later, the resistors were rechecked and found to be within the original tolerances. The attenuators were operated in grid circuits at levels of about 1 volt. Similar resistors used as plate loads failed in service.

In the original assembly, the resistor leads were sandpapered clean, then soldered with a very hot iron while the body was held under water. The underwater treatment is hardly necessary with 1- and 2-watt resistors. Just leave the leads long, clean them, then solder rapidly with a very hot iron. The amount of heat transferred to the body of the resistor depends on the length of time that the iron is applied. Make it fast. (Instead of the water bath, try the thermal shunt described on page 78 of the July 1951 issue. It is equally effective and more convenient to use. —Editor)

(If you cannot find a resistor within the desired tolerance range, select the closest value so little padding is necessary. The chances of hitting 10,000 ohms within 1% by selecting two 5,000-ohm units are slim indeed. If you start with 8,000 or 9,000 ohms, the chances of hitting 10,000 on the nose are much better because the permissible tolerance of the padding resistor is much greater. If a padder resistor changes the total resistance by 10%, a 1% change in padder resistance will change the total resistance only 0.1%.)

If the available resistor is smaller than the desired value, a padder resistor is inserted in series. Its resistance is the difference between the desired and available values.

Parallel padding is used when the available resistance is too large. If the percentage change in the total resistance produced by the padder is 20% or less, you can use the following procedure for mentally computing the padder value:

1. Divide the desired resistance value by the required reduction in resistance.
2. Multiply the figure thus obtained by the desired resistance.

For example: We need 100,000 ohms. The closest available value is 105,000 ohms—just 5,000 ohms too high. In step 1, 1,100,000 divided by 5,000 equals 20. In step 2, we multiply 20 by the desired resistance (100,000) and find that the padder resistor is 2,000,000 ohms or 2 megohms.—L. Fleming

The finest all-channel antenna ever made!

the SKYLINE

★ 28 fewer element connections

★ 8 integral elements VS. 40

★ Pre-assembled

★ Quick rigtime

★ Extra heavy—all aluminum

★ Amazing reception up to 150 miles

Patented

The Skyline foldable colinear antenna possesses higher gain with respect to signal strength because the elements are integral!

No loss of signal strength through a multiplicity of mechanical connections.

Only the Skyline continues to maintain high gain with respect to signal strength over an indefinite period of time.

The Skyline colinear antenna, with its new engineering developments, is fast replacing all other types in fringe areas.

Request further information from your local dealer

SKYLINE MFG. CO. 1458 B3 E. 17 St., Cleveland 14, Ohio

## PARTS LISTS

Bills of material for most of the pieces of equipment described in RADIO-ELECTRONICS construction articles are on hand at all radio parts jobbers and distributors who sell the magazine. See your dealer for a complete parts list of any of this apparatus you wish to construct.



# OLD TEST EQUIPMENT WANTED

Your discarded test equipment can save you over \$60.00 on a popular

## SUPREME

### MODEL 666 SIGNAL GENERATOR

Supreme needs some specimens of old test equipment to be used in a research project now underway. We need these specimens as quickly as possible so we are making this unusual offer. Supreme will ship a popular Model 666 Generator at a special price to those who send in an old tester. Instruments manufactured by Supreme prior to 1948 are preferred. There are over 175,000 in this group. A late model which has had extreme abuse or has been exposed to weather, water, or extreme temperatures is acceptable. The quantity of Model 666 Signal Generators allotted for this project is limited. As soon as the desired number of specimens is obtained, this offer will be withdrawn. Take advantage of this most unusual Supreme offer. Send your order today.

For 25 years Supreme has been a leader in designing and manufacturing high quality equipment which still performs when many others are cast aside. Thousands of Supreme Tube Testers, Multi-meters, Oscilloscopes, Signal Generators, and other types over ten years old are still in use today, proving to the world that "Supreme By Comparison" is more than just three words . . . IT'S A FACT!



**SUPREME MODEL 666 RF, AF, and TV Marker Generator** is the most ideal signal source on the market. It cannot be beat for performance, durability, or accuracy even at many times the price. Completely variable AF oscillator (15 to 15,000 cycles) which can be used by itself, or, to modulate the RF section. RF oscillator covers 65kc to 20.5mc on fundamentals. Useful to 120mc on harmonics. Incorporates two VTVM sections for reading AF (5 Modulation) and carrier level—plus many other important features you would expect to find only in a signal generator selling for over \$225.00! Panel size 11½ x 15½ inches. Weight, 35 pounds.

REGULAR PRICE \$141.60. SPECIAL PRICE TO THOSE WHO SEND A DISCARDED TESTER WITH ORDER. . . . **\$79.85**

Supreme will pay shipping charges on the Model 666 when full amount (\$79.85) is sent with order. If C.O.D. shipment is desired, send 20% deposit. For prompt delivery of your Model 666, send transportation receipt showing prepaid shipment of old tester with your order. Shipment can then be made before old tester is received by us. This is an unusual opportunity for many who have long wanted to own one of these popular, high quality Supreme Generators. Buying a Supreme instrument is not an expense—it is the best money-making investment you can make. All Supreme instruments are fully guaranteed for one year from date of shipment from factory.

Supreme, Incorporated, Greenwood 14, Mississippi

Our 25th Year

# SUPREME

Testing Instruments

"SUPREME BY COMPARISON"

OCTOBER, 1952

## POWER-LINE TV ANTENNA

The old trick of using the power line for an antenna will work with TV sets in good locations. I found that a power-line antenna actually works better than the built-in antennas in some sets. It will probably be very useful to the technician who does not have access to an outside antenna when he is servicing a set. (Warning: Power-line antennas can produce queer effects of their own. Don't get confused!)

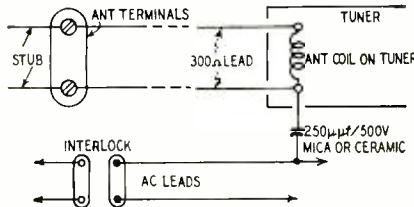

I used a 250-µf mica capacitor between one side of the 300-ohm antenna input terminals and one side of the a.c. line. I got good ghost-free pictures on channels 4 and 5, the only two low-channel stations in this area. Channel 7 was snowy, but by attaching a 300-ohm line stub of the right length to the antenna connectors I got a good picture on that channel.

I got best results with the circuit drawn above. Try the capacitor on each side of the antenna coil and reverse the a.c. line plug for best reception. —B. W. Welz

## USING THERMAL RELAYS

Heat-operated switches (thermostats) such as the Fenwall Theroswitch type 1565, have a number of useful applications in the home, ham shack, laboratory, and on the farm. They have normally-closed contacts which can be adjusted to open at any temperature from well below zero to 400° F. In the home, they can be used to control exhaust fans in the kitchen, basement, or attic. A few may be installed in the attic, basement, garage, barn, or any place where a fire is likely to start and burn unnoticed. They can be connected to an alarm system and set to go off when the temperature rises above normal.

Amateurs can use them to control cooling blowers or heat elements in precision oscillators. One can be taped to the side of a power transformer and set to open the circuit when the transformer gets hotter than normal.

Fruit growers can set them to turn on an alarm when the temperature drops to the point where frost is likely to form.

The thermostat can be used as the control unit of a time-delay circuit. The unit may be taped to the side of a light bulb or enclosed in a small oven with a heating element. The timed interval is started by turning on the light or heater and is ended when the temperature rises enough to open the switch contacts. The timed interval can be varied over wide limits by using bulbs or heaters of different wattages and different settings of the temperature control.—O. C. Vidden



## RELAYS... WORLD'S LARGEST STOCK!

Your requirements of large or small quantities of relays can be quickly supplied from our huge stock.



Wide variety of types, all made by leading manufacturers. Each relay is brand new, inspected and fully guaranteed by Relay Sales.

- ✓ STANDARD TELEPHONE RELAYS
- ✓ SHORT TELEPHONE RELAYS
- ✓ DUAL TELEPHONE RELAYS
- ✓ SLOW ACTING RELAYS
- ✓ SEALED RELAYS
- ✓ ROTARY RELAYS
- ✓ MIDGET RELAYS
- ✓ KEYING RELAYS
- ✓ DIFFERENTIAL RELAYS
- ✓ PLATE CURRENT RELAYS
- ✓ ANTENNA SWITCHING RELAYS
- ✓ "BK" SERIES
- ✓ STEPPERS & RATCHET RELAYS
- ✓ LATCHING & INTERLOCKING RELAYS
- ✓ MECHANICAL ACTION RELAYS
- ✓ VOLTAGE REGULATORS
- ✓ OVERLOAD & CIRCUIT BREAKERS
- ✓ REVERSE CURRENT RELAYS
- ✓ AIRCRAFT CONTACTORS
- ✓ MOTOR & CONTROL DEVICES
- ✓ TIMERS
- ✓ SOLENOIDS
- ✓ RELAY ASSEMBLIES



New  
RELAY SALES  
CATALOG  
NOW READY

WRITE FOR YOUR  
COPY TODAY



833 W. CHICAGO AVE.  
DEPT. 10, CHICAGO 22, ILL.

END

# WINCHARGER

## NEW LOW COST TELESCOPING TV ANTENNA SUPPORT

Pat. Applied For  
Wincharger . . . pioneer in guyed tower, presents a new design in HIGH QUALITY, RUGGED, DURABLE TV Antenna Support Masts at a budget price. Properly guyed, these masts will support large antenna arrays against high winds and heavy ice loads.

**SAFER  
EASIER  
FASTER**

### Exclusive 3-Point SAFETY CLAMPING RING

with a smoother guying surface, provide maximum rigidity against tubes twisting and loosening inside each other due to high winds. Aids in erecting a straighter mast.



### AUTOMATIC SAFETY CLIP



Assembly Tool. Snaps in place with a "click", warning that tube has been pulled out as far as it can safely go. Made of heavy-gauge spring steel wire. This is an exclusive Wincharger safety feature.

### A WINCHARGER BASE FOR EVERY TYPE ROOF

Hinged Foot for flat and sloping roofs.

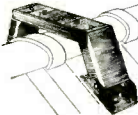
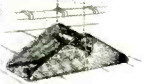

Ridge Straddler . . . for use on broad or ridged roofs, such as tile, etc.

Ridge Straps . . . A simple mounting where there is no ridge roll to bridge.



Sell WINCHARGER

**SAFETY and FASTER, EASIER INSTALLATION.**

Sell WINCHARGER

### TELESCOPING TV ANTENNA SUPPORT MASTS

Order now from your jobber— or write for complete details

**WINCHARGER CORPORATION**  
SIOUX CITY 2, IOWA

### OSCILLOSCOPE CONVERSION

Ordinary oscilloscopes with free-running recurrent sweeps will not give clear pictures of transients or unstable recurrent waveforms even with full synchronization. Special scopes (synchrosopes) are needed for viewing waves of these types. These have "one-shot" sweeps that produce a trace *only* when a sync pulse is applied.

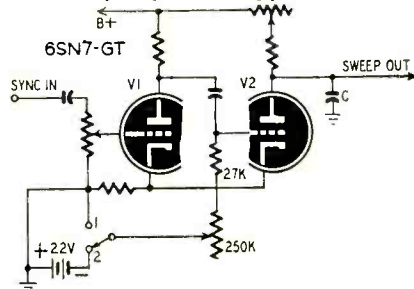

Fig. 1—Bias battery in fine-frequency control circuit gives "one-shot" sweep.

Any standard scope with a *multivibrator* sweep oscillator can be easily converted to operate as a synchroscope. For example, in many scopes, the arm of the fine frequency control—which biases the discharge tube—is normally grounded. Fig. 1 shows the circuit modified by connecting the arm to a s.p.d.t. switch. In position 1 the arm is grounded for normal recurrent sweep. In position 2 a fixed negative bias of 22.5 volts holds the tube below cutoff

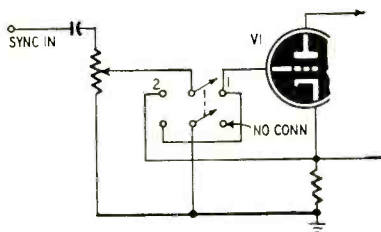

Fig. 2—Input selector for triggering sweep with positive or negative sync.

and prevents sweep capacitor C from discharging. The spot is held at the right-hand edge of the screen until a 3 or 4-volt *negative* pulse at the sync input triggers the circuit. Capacitor C discharges, returning the beam to the left, and recharges slowly to form the sweep trace. A single sweep is produced for each trigger pulse. The scope controls must be set so the charging time of capacitor C is long compared to the duration of the pulse to be viewed.—H. J. Carter

(A d.p.d.t. switch may be added as shown in Fig. 2 to provide for either positive or negative trigger pulses. In position 1 negative trigger pulses are applied to the grid; in position 2 the grid is grounded and positive pulses are applied to the cathode. Both switches and the battery terminals can be mounted on the oscilloscope panel.—Editor)

### NOVEL OHMMETER CIRCUIT

Conventional ohmmeters have the following disadvantages when used for checking resistances in electronic and electrical equipment:

1. Scale graduations are wide

# STAN-BURN

## ANTENNAE SPECIALS

DOUBLE V 3/4"	\$2.98	12 or more \$2.20
DOUBLE V 3/8" Dowel	3.45	2.45
DOUBLE V 1/2" Dowel	3.95	2.95
10 Element Conical 3/8"	3.55	2.55
Folded Ht Straight Low Quick	4.25	3.25
Rig 1/2" elements	4.95	3.75
WINDOW CONICALS		
5 FOOT SWEDGED	.79	.69
10 FOOT PLAIN	1.39	1.29
55 Mil. 300 OHM		\$14.95 M Ft.
72 OHM COAXIAL		45.00 M Ft.

## CATHODE RAY TUBE SPECIALS

10BP4A Sheldon	\$13.95	17BP4A Federal	23.00
10BP4A N.U.	18.95	19AP4A Sheldon	29.95
12LP4 Sheldon	15.95	19AP4A GE	38.00
12LP4A Thomas	19.95	19BP4A Thomas	39.95
16AP4 Sheldon	24.00	19BP4A Sheldon	29.95
16AP4A GE	34.20	20CP4A Dumont	37.00
16DP4A Thomas	28.80	20CP4A Sheldon	31.00
16BP4A Sheldon	24.00	21EP4A Federal	29.00
16GP4 Sheldon	24.00	21EP4A Dumont	39.00
18GP4A Rauland	30.25	24AP4A Sheldon	63.00
18IP4A Sheldon	24.00	24AP4A GE	68.40
18RP4A GE & NU	23.40	Single ion traps	.39
18KP4A Sheldon	24.00	Double ion traps	.59

CHASSIS 830 REGAL with Cascade Tuner. \$139.50  
211 T3 Tube Bag (Similar to RCA) . . . 2.98  
OPEN FACE CABINET . . . 39.00

## TRANSFORMERS

RCA type for 16" to 24" X032	\$3.85
G.E. type for 16" to 24" X045	3.85

These are very special prices while they last!

## DEFLECTION YOKES

Cosine Ferrite Todd Yoke 70°	\$4.20
------------------------------	--------

## SPECIALS

4 Prong Vibrators, each	\$1.29
Lots of 12 or more	1.19
Standard TV Tuners	18.95
12" Heavy Slug Speaker	Special 4.98

## Audio Devices, Discs, and Scotch Tape in Stock

Audio Plastic Red Oxide Plastic tape—	
Half hour spool	\$2.30
One hour spool	3.30

## WIRE RECORDERS IN STOCK

WILCOX GAY—Model 2A10	\$89.97
PENTRON—Model 913C—2 spd. Tape R'cdr net	134.50
Model RC2-BHF Amplifier	42.89
CRAFTS—Model RC10—AM-FM Tuner	130.84
MEN—Model C5—Williamson Amplifier net	99.45

CANCODE Guaranteed Tuners (with tubes)  
Special while they last. . . \$21.95

## AUTHORIZED DISTRIBUTORS for: General Electric, Kenrad, Tung-Sol, National Union, Jewel, De Wald, Regal, Automatic and Setchel Carbon

We carry a complete line of popular makes of radio and TV tubes, at 50% discount. Also many other special purpose and transmitting types, and all electronic parts and equipment at lowest prices. Send us list of your requirements for prompt quotations. Terms: 20% with order. Balance COD All prices FOB. New York Warehouse. Minimum order \$5.00

Write for our latest price list to Dept. RE-10

**STAN-BURN RADIO and ELECTRONICS CO.**  
(C.B.S. THEATRE BLDG.)  
1697 BROADWAY • NEW YORK 19, N.Y.

## WEBSTER-VM-G.I.

### 3-SPEED RECORD CHANGERS

Fully automatic. Plays all size records 7", 10", 12". BRAND NEW. G. I. CHANGER. OUR PRICE \$15.95



Immediate Delivery \$47.50 List. 12"x12 3/4"

Long life needle incl. ORDER YOURS TODAY. Comes with RCA plug to attach to your radio or TV set. Metal base for above \$3.50. Fully guaranteed. Original factory cartons.

NOT MANY LEFT AT THIS PRICE

### REPLACE YOUR OLD CHANGER NOW!

RCA VICTOR—2-SPEED CHANGER	
Same as VM Model 950.	
2 Needles	17.95
VM #950 Flip Cart. 3 speed.	22.95
WEBSTER #100 Flip Cart.	24.95
WEBSTER 100 with G.E. Triple Play Reluctance Cartridge	30.95
VM #950 with G.E. triple play variable reluctance cartridge	28.95
Pre-Amp with tube for G.E. Cart.	4.95
METAL BASE for Webster or VM.	3.50

### PHONO AMPLIFIER

3 tube amplifier 8" speaker volume and tone controls with tubes. Ready to operate. Same as used in portable phonographs . . . \$7.95

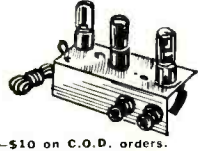

Send for descriptive literature. Please include shipping charges. Come in or order by mail—\$10 on C.O.D. orders. Send for free catalog

JAN ELECTRONIC DIST. CO., Dept. R.E.  
222 Fulton St. New York 7, N.Y. WO. 4-0632



open at the center of the dial and accuracy is higher than usually required. At the ends, markings are crowded and difficult to read, and accuracy is often lower than the tolerance of conventional resistors.

2. Several ranges must be provided to insure high accuracy on the lower ranges.

3. The operator must take care to remove all voltages and to discharge any heavy capacitors which may be in the circuit under test, or heavy currents may flow through the instrument and damage the meter movement or its calibrating resistors.

A novel ohmmeter which has a single range with expanded graduations at the low end of its scale and internal protection against damage by external voltages is described in patent No. 2,583,130 issued to Woodrow F. Wrolson and Harold Overdick. The circuit of the units is shown in the diagram at *a* and the drawing of a typical dial scale of the instrument is shown at *b*.

Resistors R1 and R2, the 100- $\mu$ a meter, and batteries BA1 and BA2 are in series across the test terminals in the usual ohmmeter circuit. R2 is selected so its resistance plus the resistance of the meter equals the resistance of R1.

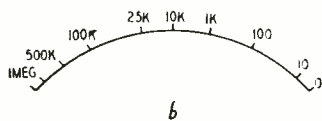
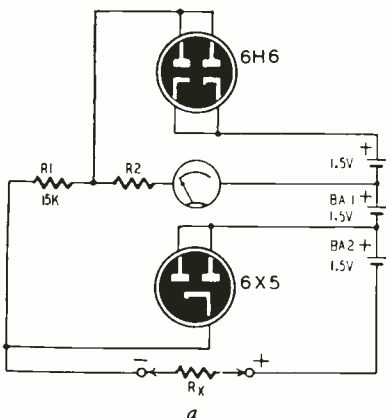

The 6X5 connected in series with BA1 across the meter and R1 and R2 spreads the dial markings at the low end of the dial so the 10-ohm point falls at about the same place as 1,000-ohm point on a conventional ohmmeter.

When  $R_x$  is a comparatively low value, the current flowing through it from BA1 and BA2 is high. A part of this current flows through the meter and the rest is bypassed through the 6X5. This reduces the current through the meter and causes the calibration to fall to the left of the point it would take if the 6X5 were left out of the circuit. As the resistance of  $R_x$  increases, the voltage drop across it increases and effectively subtracts from the voltage between plate and cathode of the 6X5. This causes the resistance of the tube to increase, lower-

# NOW!...RCP gives you 2 sensational new test instruments for all your TV SERVICING needs!

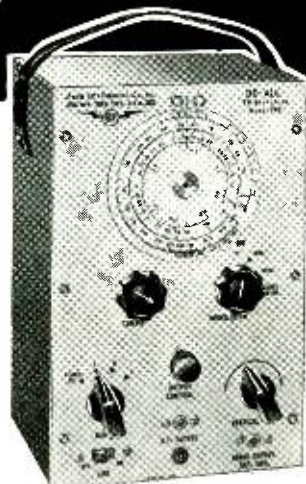

**MODEL 740 TV "Do-All" Generator**

**IT'S A SIGNAL GENERATOR:**  
Covers every channel (VHF and every IF band on any TV or FM receiver—ALL ON FUNDAMENTALS.

**AN AUDIO GENERATOR**  
**A MARKER GENERATOR:**  
Accurate to within 1/10 of 1% on 9-11 megacycle band, and better than 1/2 of 1% overall. Perfect for alignment.

**A PATTERN GENERATOR**  
THE only single easily portable instrument that provides for testing and alignment of: Front Ends, IF's, Horizontal and Vertical Linearity, Syncs, Sweeps, Size, Position, Focus Coil, Deflection Coil, Ion Trap

**MODEL 740—Complete with \$69.50 NET**  
output cable, ready to operate



**MODEL 808 TV SET & TUBE TESTER**  
(Includes VT Voltmeter and Reactivator)

**ALL IN ONE UNIT:**

- A TUBE TESTER
- A CATHODE RAY TUBE TESTER
- A CATHODE RAY TUBE REACTIVATOR
- A VACUUM TUBE VOLTMETER (AC-DC)
- AN OHMMETER

Housed in handsome hand-rubbed oak carrying case with test leads, isolation probe, batteries, etc. Size: 12 1/2" x 12 3/4" x 4 3/4". Weight: 12 lbs.

**MODEL 808—Complete, \$99.95 NET**  
ready to operate

High voltage multiplier Probe for Model 808, extends range of VTVM to 30,000 volts. **\$89.95 NET**  
MODEL No. HVMP-1

Write for the latest RCP Catalog to Dept. RE-10

**RADIO CITY PRODUCTS CO., INC.**

152 WEST 25th ST • NEW YORK 1, N. Y.



You can't beat

**Radio-Electronics**

for complete coverage of

**Radio, Television and Audio**

**500 FORMULAS TO SUCCESS**

MANY million dollar firms started with a single formula, for which they paid a big price. Here you have 500—no less—tried and tested formulas, recipes and processes for making things... all at the ridiculously low price of 25c. Here is your opportunity to start a business with but a few dollars' capital and with undreamed of profits in prospect. You can also use these formulas in your own home to cut household expenses to the bone. Or you can put them to use in your workshop to cut costs as much as 100%. Quit paying out many dollars in profits to manufacturers, wholesalers, and dealers, when you can make the same thing yourself for a few cents. It's so easy when you follow our simple instructions.

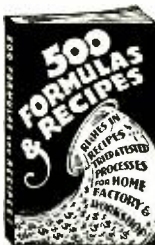

66 PAGES. 47,000 WORDS IN TEXT  
Send for "500 FORMULAS AND RECIPES" today. Enclose 25c, that's all! You won't be asked for another cent now or later. Sold on a money-back guarantee.

**NATIONAL PLANS COMPANY**  
1966R Broadway, New York 23, N. Y.

# Your best book buy!

The new Gernsback Library

**Streamlined!  
Enlarged!**

Gives you thorough and accurate coverage of practical electronics at just a fraction of the usual cost of technical books!



## Check these important new books on RADIO • TV • AUDIO!

**TELEVISION TECHNICAL NOTES.** No. 46—\$1.50. Cuts down on TV trouble-shooting time! Tells you how to find and correct more than 600 troublesome bugs which have cropped up in scores of sets made by 27 leading manufacturers. Compiled by the editors of RADIO-ELECTRONICS from the reports of practicing service technicians and from manufacturers' servicing notes. 128 pages.

**BASIC RADIO COURSE.** No. 44—\$2.25. By John T. Frye. At last a book that actually makes learning fundamentals a pleasure! RADIO-ELECTRONICS' popular technician-writer leads you along the rocky path of theory from Ohm's Law to an understanding of advanced servicing techniques and makes what you've learned stick. 176 pages. Durable hard cover.

**RADIO TUBE FUNDAMENTALS.** No. 45—\$1.00. Gets right to the heart of radio! Gives you a clear understanding of what radio tubes are and how they work in a circuit. Used as a reference text at New York University. The author is an instructor and engineer. 96 pages.

**MODEL CONTROL BY RADIO.** No. 43—\$1.00. Tells what radio control is and how to use it in model airplanes, boats and autos. Covers construction of coders, transmitting and receiving systems and other components as well as complete systems. 112 pages.

**HIGH-FIDELITY TECHNIQUES.** No. 42—\$1.00. By James R. Langham. Probably the best book on hi-fi ever written—at any price! In a spicily and highly readable style. RADIO-ELECTRONICS' famous audio writer tells you how to design your own equipment and get top performance from it. 112 pages.

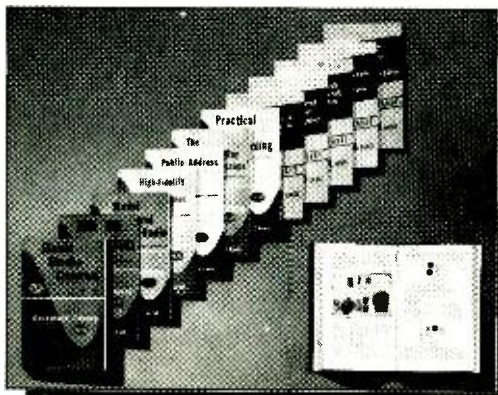

## Have you read these acclaimed best sellers?

**PUBLIC ADDRESS GUIDE.** No. 41—75c. Tells how to earn more money in PA work! Covers installation, maintenance, construction. Construction details for a system to handle 90% of all P.A. jobs.

**AMPLIFIER BUILDER'S GUIDE.** No. 33—50c. For the designer and builder of audio equipment. A wide range of technical data on amplifier design and construction. Proven best-seller!

**UNUSUAL PATENTED CIRCUITS.** No. 30—50¢. A gold mine of important hook-ups. Control circuits, detectors, amplifiers, power supplies and foreign circuits.

**HANDY KINKS AND SHORT CUTS.** No. 29—50¢. A treasury of time savers! Antennas, power supplies, test equipment, etc. A great value at this give-away price!

**THE CATHODE-RAY OSCILLOSCOPE.** No. 40—75c. How the 'scope works and how to use it in servicing TV, FM and AM receivers, amateur equipment and audio amplifiers.

**ADVANCED SERVICE TECHNIQUE.** No. 32—50c. Devoted to specialized problems not found in ordinary texts. A treasury of ideas, methods and procedures for advanced technicians.

**PRACTICAL DISC RECORDING.** No. 39—75c. Covers theory as well as technique. A full chapter for each component. Explains in practical detail the elements of making quality records.

**RADIO QUESTIONS & ANSWERS.** No. 31—50c. Answers your tough ones on circuits, amplifiers, transmitters, etc. Diversified practical information which can be put to daily use.

See your distributor—or mail this coupon

**RADCRAFT PUBLICATIONS, INC., Dept. 10-52**  
25 West Broadway  
New York 7, N. Y.

Enclosed is my remittance of \$ \_\_\_\_\_  
Please send me postpaid the books checked below:

46  45  44  43  42  41  40  
 39  33  32  31  30  29

Name \_\_\_\_\_  
(Please print clearly.)

Street \_\_\_\_\_

City \_\_\_\_\_ Zone \_\_\_\_\_ State \_\_\_\_\_

The Gernsback Library is published by the publishers of  
**RADIO-ELECTRONICS**

ing the amount of current shunted around the meter. When  $R_x$  is large enough to produce a drop of  $1\frac{1}{2}$  volts, the plate-cathode voltage of the 6X5 is zero and full current passes through the meter. From this point on, the scale graduations conform to those of a conventional ohmmeter.

If the instrument is unintentionally connected to a power supply with the negative side connected to the negative test terminal, the 6X5 conducts and bypasses the current around the meter. The 6H6 protects the meter against accidental damage through the application of voltages of reverse polarity. With the two tubes protecting the meter against d.c. voltages of opposite polarities, the instrument is automatically protected against damage by alternating voltages.

### RADIOTELEPHONE RELAY

Have you ever heard hams relaying radiotelephone transmissions from other stations or a net control station retransmitting the activities of a 2-meter net on a lower frequency? If you have, you've probably wondered how it was done. The figure shows a setup for automatically making simultaneous retransmissions.

T1 is the output transformer of the receiver being used to pick up the signal to be relayed. It should have a 500-ohm secondary and preferably a second secondary winding for feeding headphones. Receivers having a 500-ohm audio output include the Hallicrafters SX-25, SX-28, and SX-43, the Hammarlund Super-Pro, and Collins receivers of the 75 series. The HQ-129 and most National receivers have low-impedance output windings so the circuit will have to be modified or the output transformer replaced.

T2 is a line transformer to match a 500-ohm line to the grid of a voltage-amplifier tube. Your junk box may provide an old double-button mike transformer which makes a good substitute. The secondary of this transformer connects to the grid of the stage preceding the driver stage for the class-B modulators. If the rig uses NBFM or some form of efficiency modulation, i.e. grid, screen, cathode, or clamp modulation, connect the secondary of T2 to the grid circuit of the stage following the stage in which the audio gain control is located. If the speech-amplifier is push-pull at this point, the secondary winding connects between the two grids instead of between a grid and ground.

T3 is the line-to-voice coil transformer to match the 500-ohm audio line to the speaker. The s.p.d.t. switch cuts in the receiver's speaker for monitoring or normal use or cuts out the speaker and T3 and substitutes a 500-ohm load resistor when the speaker is not being used.

R1 is the audio gain control for the relay patching circuit. By carefully adjusting R1 and the receiver's volume control, you can insert the proper amount of signal into the speech equipment while keeping the speaker output at a comfortable level to minimize microphone feedback. You can set the



level of the audio fed into the circuit by watching the modulator plate-current meter or by using some form of modulation indicator. Since the mixing circuit is independent of the speech-amplifier gain control, the operator of the relay station can insert comments or station announcements between pauses in the relayed transmission, or fade out the relayed transmissions to permit normal voice operation.

This simple arrangement can be used by amateur 2- or 6-meter civil emergency service nets operating in conjunction with established 10- or 75-meter nets to provide the latter with

information originating at the net control station of the higher frequency net.

Here are two precautions which must be observed:

1. The frequencies of the high- and low-frequency transmitters must not be harmonically related, otherwise harmonics of the relay transmitter may block the high-frequency receiver or cause feedback.

2. Always obtain permission from the operator of the originating station before relaying his transmissions.—  
*George Rulfs, Jr., W2CJY*

**PROTECTIVE RELAY CIRCUIT**

Various methods of reducing high voltage or preventing its application to circuit components until the tubes have reached operating temperature have been described. One system using an electronic thermal delay circuit was described on page 82 of the March, 1951, issue of RADIO-ELECTRONICS. A much simpler system, described in *Wireless World* (London, England) is designed for use on a power supply having a capacitor-input filter system. The relay contacts are wired so the input filter capacitor C1 is in parallel with C2 when the power is turned off. When the supply is first turned on, the current through the relay coil is not high enough to cause the armature to pull in. When the tube heaters have warmed up to the point where the drain is sufficient to prevent the B voltage from

soaring, the armature pulls in and switches C1 to its normal input position.

Load resistance  $R_L$  is required to keep the initial voltage to a safe value.  $R_L$ , which includes the resistance of the choke plus the equivalent resistances of the tubes and transformers, may be adjusted to the desired value by short-circuiting the relay coil and checking the output voltage with a meter.

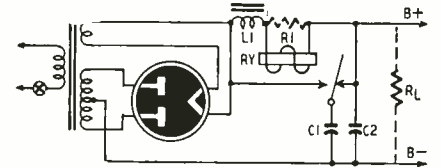

The relay should operate when the drain reaches approximately 75% of its maximum value. If the relay pulls in at a lower value, add R1 to shunt a portion of the current around the relay coil. The correct value for R1 can be found by substituting a potentiometer, setting it to zero resistance until the tubes have warmed up, then slowly increasing its resistance until the relay pulls in.

The resistance of the relay winding should be as small as possible for maximum output voltage and good regulation. For safety (especially where the positive side of the circuit is at a high voltage above ground) the relay coil can be connected in the transformer center-tap return. END

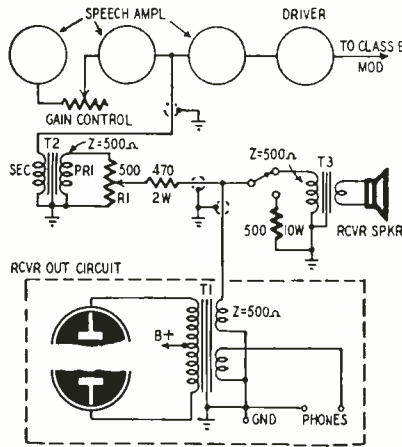

A circuit for the direct retransmission of communications network signals.

# PILOT

World leader and pioneer in electronics...  
presents the world's finest High Fidelity line

## PILOTUNER FM-AM RADIO TUNER

Behind this brilliant new Tuner stands Pilot's 33-year-old, world-wide reputation for producing the most advanced communications instruments that science has yet developed. Once enjoyed only by a select circle of engineers "in-the-know" . . . Pilot sensitivity, selectivity, stability — are now yours, in this incomparable new PILOTUNER. No better tuner can be made at any price . . . yet the Pilotuner is modest in cost, at **\$99.95**

★ Write for complete specifications

**Model AF-821**

The Pilot High Fidelity line is discussed and appraised in the practical new book, "High Fidelity Simplified", by Harold D. Weiler

### PILOTONE Amplifier Model AA-901

Designed for high fidelity audio reproduction from phonograph, AM or FM radio, television or microphone input. Full Williamson circuit. A supreme amplifier with traditional Pilot quality, exacting Pilot specifications . . . the last word for the discriminating music lover and hi-fi enthusiast, — priced at **\$99.50**

★ Write for complete specifications

### PILOTONE Pre-Amplifier Model PA-911

A companion unit for Pilotone Amplifier Model AA-901 . . . built up to the same exacting standards. Selector switch allows quick choice of Auxiliary, TV, radio or phono inputs. Handsome in appearance, unsurpassed in performance . . . exceptionally low priced at **\$29.95**

★ Write for complete specifications

The New Model 670-A

# SUPER-METER

a combination  
**VOLT-OHM MILLIAMMETER plus  
 CAPACITY REACTANCE, INDUCTANCE  
 and DECIBEL MEASUREMENTS**

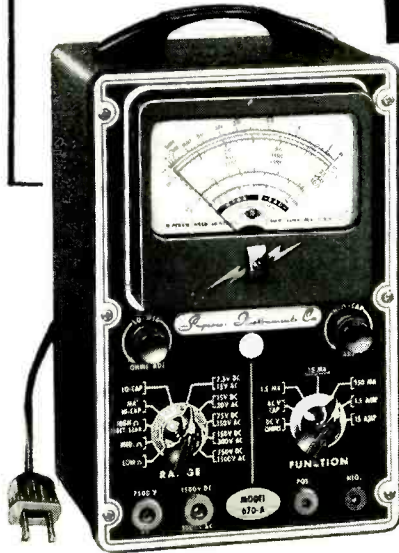

**SPECIFICATIONS:**  
**D.C. VOLTS:** 0 to 7.5/15/75/150/750/1,500/  
 7,500 Volts  
**A.C. VOLTS:** 0 to 15/30/150/300/1,500/3,000  
 Volts  
**OUTPUT VOLTS:** 0 to 15/30/150/300/1,500/  
 3,000 Volts  
**D.C. CURRENT:** 0 to 1.5/15/150 Ma.  
 0 to 1.5/15 Amperes  
**RESISTANCE:** 0 to 1,000/100,000  
 Ohms 0 to 10 Megohms  
**CAPACITY:** .001 to 1 Mfd. 1 to 50 Mfd.  
 (Quality test for electrolytics)  
**REACTANCE:** 50 to 2,500 Ohms 2,500  
 Ohms to 2.5 Megohms  
**INDUCTANCE:** .15 to 7 Henries 7 to 7,000 Henries  
**DECIBELS:** -6 to +18 +14 to +38 +34 to +58

The Model 670-A comes housed in a rugged crackle-finished steel cabinet complete with test leads and operating instructions. Size 6 1/4" x 9 1/2" x 4 1/2".

**\$28.40  
 NET**

**ADDED FEATURE**  
 The Model 670-A includes a special GOOD-BAD scale for checking the quality of electrolytic condensers at a test potential of 150 Volts.

**AT YOUR  
 RADIO  
 PARTS  
 JOBBER**

Write Dept. RC-10 for complete catalog.

Manufactured and Guaranteed by

**SUPERIOR INSTRUMENTS CO.**  
 227 Fulton Street • New York 7, N. Y.

## SPACE-CHARGE RECEIVER

? Quite a few years ago, I constructed a two-tube receiver, called the Forty-Niner, from details given in one of your publications. This set used two type 49 tubes as a regenerative detector and audio amplifier. Its interesting feature was the 12-volt B supply. Will you kindly reprint this circuit in the Question Box?—W. H. W., Bronx, N. Y.

A. Here is the circuit of the Forty-Niner. The 49's are now made "for renewal purposes" only and may be hard to find. If you have any difficulty in purchasing a pair, try some of the mail-order radio supply houses. Many of them still list this type as being available.

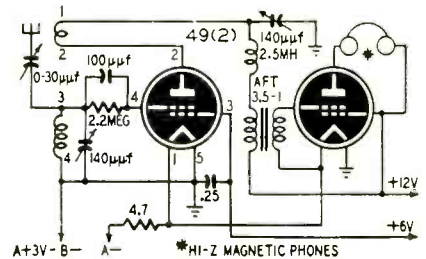

Four plug-in coils can be used for continuous tuning over the range of approximately 18 to 200 meters. The coils may be wound with No. 26 d.c.e. wire on 1 1/4-inch forms. Winding data is as follows:

Band	Grid coil	Tickler
20 meters	5 turns	4 turns
40 meters	10 turns	7 turns
80 meters	22 turns	11 turns
160 meters	45 turns	18 turns

The turns of the grid and tickler coils are close-wound. It may be necessary to experiment with the number of turns on the tickler and the spacing between the grid and tickler windings to obtain smoothest regeneration. The numbers on the ends of the coils refer to pin connections on a standard 4-prong tube base or coil form. Both coils should be wound in the same direction. If the set does not oscillate, reverse connections to the tickler winding.

## TUBE SUBSTITUTION

? I am planning to build a set of 12 frequency dividers like those described in "Electronics in Music" in the June, 1952, issue. I would like to know if I can use 6SL7-GT's in place of the 12AX7's. If so, what changes will be necessary.—R. L. H., Decatur, Ill.

A. In many circuits, the 6SL7 and 12AX7 tubes are electrically interchangeable. However, in multivibrators and similar circuits, you may have to make minor adjustments in the values of the grid resistors and capacitors to insure the proper waveform and positive synchronization. We suggest that you build a breadboard model of one of the frequency dividers and compare the operation with both types of tubes. Substituting variable resistors for the fixed units will enable you to study the effects of resistance changes on the performance.

## H. G. CISIN'S NEW RAPID TROUBLE SHOOTING & ALIGNMENT TV CONSULTANT

**THIS AMAZING NEW TV BOOK  
 YOURS TO TRY 5 DAYS FREE!**

WITHOUT experience or knowledge, this fast, easy, new method of TV servicing enables the novice to diagnose TV troubles expertly.

**NO THEORY—NO MATH**—copyrighted method locates all faults in record-breaking time, regardless of make or model. Shows simple, quick step-by-step **ALIGNMENT** methods and explains by pictures, diagrams and in easily understood language **HOW, WHEN** and **WHERE** to use **TV TEST INSTRUMENTS**.

Most complete and practical book on **TV TROUBLE SHOOTING** and **ALIGNMENT** ever written! Contains over 300 picture, raster and sound troubles and more than 135 **RAPID CHECKS**, many requiring no instruments, instead using picture tube as guide.

This book has a complete section on installation and servicing of **UHF** units; addition of **UHF CONVERTERS** to **VHF** sets; servicing **UHF**; tracing faults in **UHF** sets and converters; test instruments for **UHF** servicing. Also contains over 125 illustrations including **TV picture faults**, station patterns, scope waveforms, diagrams—everything needed to take the mystery out of **TV** servicing.

**TV CONSULTANT** is the ideal reference book for the TV expert, the service bench, the TV tool kit and for schools.

Price \$2 postpaid

**GUARANTEED, MONEY BACK IN 5 DAYS IF NOT SATISFIED.** Mail this coupon with only \$2—send name and address today!

**RUSH COUPON NOW!**

H. G. CISIN, Consulting Engineer Dept. E-15  
 200 Clinton Street, Brooklyn 2, N. Y.  
 Please RUSH postpaid your new book on TV Trouble Shooting and Alignment—"TV CONSULTANT". Enclosed find \$2.

Name.....  
 Address.....  
 City.....Zone.....State.....

From "WHOLESALE" GE Headquarters

# INVENTORY REDUCING SALE!

Brand New, Genuine  
**GENERAL ELECTRIC  
 TV FRONT ENDS**

**PRE-ALIGNED! ALL WITH TUBES!**

Reg. \$27. Model RJX-023. Replacement for GE models 810; 811; 820; 835; 810. **\$12.95**

Reg. \$31.50. Model RJX-027. Replacement for GE models 800A-C; 805; 806; 807; 809; 817; 818; 821. **13.50**

Reg. \$31.50. Model RJX-028. Replacement for GE models 800-A-B-C; 805; 806; 807; 809. **13.50**

Reg. \$31.50. Model RJX-036. Replacement for GE models 10T1-T1-T5-T6; 10T101-102. **16.50**

Reg. \$31.50. Model RJX-037. Replacement for GE models 12K1, 12T1, 12C101, 12C102. **16.50**

Reg. \$33.00. Model RJX-038. Replacement for GE models 10T101-102; 12C105. **16.50**

Reg. \$39.00. Model RJX-040. Replacement for GE models 12T3-13-17; 12C107, 12C108-109; 10T1; 10T2; 30T30-111-115. **16.50**

**New, Low Prices On Other GE Components**

RTO-064 Vert. Sweep Transformer.....2.67  
 RTO-085 Horiz. Sweep Transformer.....5.37  
 RTO-092 Horiz. Sweep Transformer.....5.37

Address Orders to Dept. RE-10  
 Write For Free FYI Flyer

**WHOLESALE  
 RADIO PARTS CO., Inc.**  
 311 W. Baltimore St.  
**BALTIMORE 1, MD.**



**K I T S** **RADIOS** 1 2 & 3 band Electric and/or battery **K I T S**  
**TELEVISION** AC/DC Operation  
**TEST INSTRUMENTS**  
 Write for **FREE** Catalog  
**ARKAY—Radio Kits, Inc.**  
 120 Cedar St., New York 6, N. Y.

STANDARD BRAND TUBES  
 Individually boxed, fully guaranteed

6AV6 .....	40¢	12AU7 .....	50¢
6BA6 .....	42¢	12SJ7 .....	45¢
6J6 .....	60¢	25L6GT .....	45¢
6SN7GT .....	60¢	50B5 .....	45¢

Other Tubes at above Low Prices! Remit in full or 25% deposit required on each C.O.D. order F.O.B. N.Y.C. Minimum order \$5.00.

**ALLIED ELECTRONIC SALES**  
 136 Liberty St., N. Y. CO 7-4320

**TELEVISION**  
 Big demand for graduates

B.S. DEGREE IN 27 MONTHS in radio including TV engineering—VHF, UHF, AM, and FM. Students use over \$100,000 worth of equipment including 2 large commercial type transmitters in new TV lab. Intense specialized course includes strong basis in mathematics, science and advanced design in radio and TV.

Hundreds of young men each year are earning engineering degrees in this recognized institution. Start any quarter. Many earn a major part of expenses in this industrial center. Low tuition. Competent instruction. Thorough, intense, practical program.

Also B.S. DEGREE IN 27 MO. in Aeronautical, Chemical, Civil, Electrical and Mechanical Engineering. G.I. Gov't approved. Enter Dec., March, June, Sept. Free catalog. **ENROLL NOW**

**INDIANA TECHNICAL COLLEGE**  
 17102 E. Washington Blvd., Fort Wayne 2, Indiana

**RADELCO**

**LIGHTNING ARRESTOR**

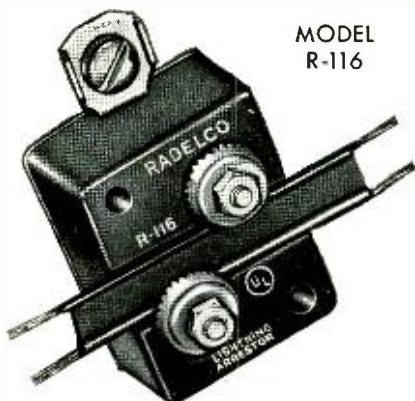

MODEL R-116

IT'S THE LOWEST PRICE UNDERWRITERS' LISTED ARRESTOR ON THE MARKET

ORDER FROM YOUR NEAREST PARTS JOBBER

LIST PRICE **90¢**

**MONEY SAVER KITS from RADIO DEALERS SUPPLY CO.**

**5 TUBE AC-DC SUPERHET KIT**

Kit #1—Five Tube superheterodyne kit, A.C.-D.C. contains all components required to construct this latest design, highly sensitive superheterodyne broadcast receiver complete with black bakelite cabinet (excludes wire and solder) ..... Price **\$7.95**  
 Extra for a kit of 5 tubes (12AT6, 12BA6, 12BE6, 35WA, 50C5). Price \$3.25.

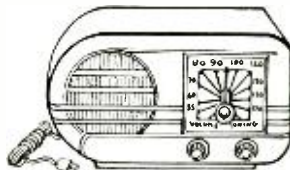

Kit #2—A low-priced 6 TUBE KIT designed for high sensitivity, excellent selectivity and good tone quality. Uses 25L6, 25Z6, 6SQ7, 6SA7, 6SK7, 6SK7 in an easily constructed circuit. The 6 Tube Kit is shipped with all parts, including punched chassis, resistors, condensers, coil, sockets, PM Speaker, hardware, etc.  
 And at a closeout price of only **\$6.95** less tubes and cabinet

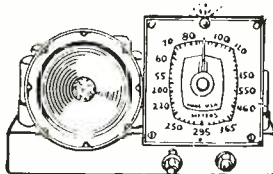

Extra for matched set of six tubes for kit **\$3.25**

Satisfaction guaranteed on all merchandise. All prices subject to change without notice.

Write for **FREE** Catalog.

**RADIO DEALERS SUPPLY CO., 154 GREENWICH ST., NEW YORK, N. Y.**

**Electronic Code Practice Oscillator & Blinker Kit**

AC/DC or Battery Operated!  
 Kit #3—One of the most practical Code Practice Oscillators ever designed, yet one of the simplest to build and operate.  
 Can be used with any number of headphones. Adjustable Pitch Control—Any type of headphone can be used.  
 No warmup time—ready to operate instantly  
 Simple and safe to operate  
 Operates anywhere—with AC or DC power, or from a 90 volt Miniature Battery  
 Learn Blinker Code with flashing light  
 Blinker can be used as signaling device  
 International Morse Code included

Kit each **\$195** Assembled **\$295**

Kit #4—Basic 1 tube training kit. Simple to construct complete with all parts one tube and headset diagrams and instructions included. Use 1-354 tube and a 67½ volt Battery. Price **\$3.95**—less Battery.

Kit #5—2 tube Amplifier Kit complete with 50L6, 35Z5, and 4" PM to convert Kit No. 1 to a 3 tube set for loudspeaker operation. **\$4.95**

**THREE TUBE PHONO AMPLIFIER**

Not a Kit!  
 An assembled unit ready for installation using tone and volume control and six feet of rubber cord ..... **\$2.95**  
 (Not including Tubes)  
 With Complete Set of Tubes ..... **\$3.95**

**PHONO OSCILLATOR**

Not a Kit!  
 Wireless phono oscillator transmits recording for crystal pick-ups or voice from carbon mike through radio without wires. Can also be used as an intercom by using P.M. speaker as mike. Price (excluding tubes) ..... **\$2.95**  
 With Complete Set of Tubes ..... **\$3.95**

**AMPERITE**

Studio Microphones at P.A. Prices

Ideal for BROADCASTING RECORDING PUBLIC ADDRESS

"The ultimate in microphone quality," says Evan Rushing, sound engineer of the Hotel New Yorker.

- Shout right into the new Amperite Micro-1 phone—or stand 2 feet away—reproduction is always perfect.
- Not affected by any climatic conditions.
- Guaranteed to withstand severe "knocking around."



Models  
 RBLG—200 ohms  
 RBHG—Hi-imp.  
 List \$42.00



"Kontak" Mikes  
 Model SKH, list \$12.00  
 Model KKH, list \$18.00

Special Offer: Write for Special Introductory Offer, and 4-page illustrated folder.

**AMPERITE Company, Inc.**  
 361 BROADWAY • NEW YORK 12, N. Y.  
 Canada: Atlas Radio Corp., Ltd., 560 King St. W., Toronto

**YOU CAN NOW ENJOY**

**FM DX**

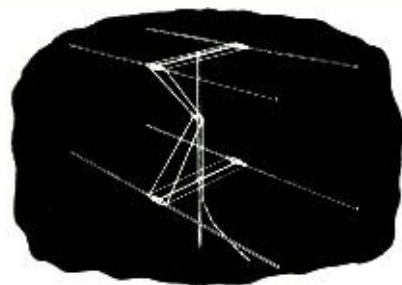

with the sensational new

**GONSET FM RADARRAY**

For the first time you can enjoy FM reception at long distances. With a gain of 10 db. over the entire FM band, this antenna makes possible satisfactory performance of FM tuners far beyond normal service areas. With its directional characteristics multipath distortion is eliminated.

See your Jobber now for the GONSET FM RADARRAY



Model 1517 **GONSET** \$47.50 list (Use mail and lead in)  
**GONSET CO. 801 S. MAIN ST. BURBANK, CALIF.**

standard brands  
**TUBES** **SAVE!**  
individually boxed

0Z4 .... \$ .45	5Y3G .... .35	6BA6 .... .49	6F6GT .. .49	6W4GT .. .49	19T8 .... .79
1L4 .... .59	6AB4 .... .55	6BA7 .... .69	6H6 .... .51	6W6GT .. .59	25AV5GT .95
1R5 .... .59	6AC7 .... .89	6BC5 .... .59	6J5GT .. .49	6X4 .... .44	25BQ6GT .98
1S4 .... .69	6AG5 .... .59	6BE6 .... .52	6J6 .... .69	6X5GT .. .39	25L6GT .. .49
1S5 .... .59	6AG7 .... .95	6BF5 .... .63	6K6GT .. .49	12AT6 .. .42	25Z6GT .. .45
1T4 .... .59	6AH6 .... .95	6BG6G .. 1.49	6L6GA .. .95	12AT7 .. .59	35B5 .... .55
1U4 .... .63	6AK5 .... .85	6BH6 .... .65	6SA7GT .55	12AU6 .. .49	35C5 .... .55
1U5 .... .55	6AL5 .... .39	6BL7 .... .89	6SC7 .. .59	12AU7 .. .52	35L6GT .. .55
1X2A .. .69	6AQ5 .... .45	6BL7 .... .89	6SN7GT .66	12BA6 .. .49	35W4 .... .37
1B3GT .. .72	6AQ6 .... .45	6BN6 .... .85	6SF5 .... .52	12BE6 .. .52	35Z5GT .. .35
3Q4 .... .68	6AR5 .... .49	6BQ6 .... .98	6SH7 .... .59	12BH7 .. .69	50B5 .... .55
3Q5GT .. .65	6AS5 .... .56	6BQ7 .... .98	6SJ7 .... .49	12SA7GT .56	50C5 .... .55
3S4 .... .59	6AT6 .... .41	6C4 .... .44	6SL7GT .59	12SG7 .. .55	50L6GT .. .54
3V4 .... .59	6AU6 .... .47	6C5 .... .51	6SQ7GT .45	12SK7GT .57	117N7GT 1.35
5T4 .... 1.19	6AV5GT .95	6CB6 .... .59	6SR7 .... .45	12SN7GT .66	117P7GT 1.35
5U4G .. .47	6AV6 .... .41	6CD6G .. 1.65	6T8 .... .79	12SQ7GT .57	117Z3 .. .49
5V4G .. .79	6BG6G .. .89	6E5 .... .69	6V6GT .. .51	19B6G .. 1.59	

Many other types equally low priced—include all your tube needs with your order.  
Above prices effective Sept. 15, 1952. One of the largest stocks in the country!  
Min. Order \$25.00. Terms: 25% with order, balance C.O.D.  
All merchandise subject to prior sale, F.O.B. New York City. Mail order division.

**TeleVision Materials Corp.**  
120 LIBERTY ST., NEW YORK 6, N.Y. • COntlandt 7-4307

PLEASE MENTION RADIO-ELECTRONICS WHEN WRITING ADVERTISERS

**Do You Run a SERVICE SHOP?**

... then You'll Surely PROFIT by these Instruments—  
LOW IN COST • PAY FOR THEMSELVES QUICKLY

**CRT TESTER-REACTIVATOR**

2 Instruments in One: It's a **Picture Tube Tester**: Tests quickly and accurately all picture tubes—in the set or in the carton. It's also a **Picture Tube Reactivator**: Renews brightness of dim tubes with only a few minutes of application. Almost 75% of low emission tubes—whether practically new or very old—are vastly improved with this famous Transvision Instrument.

**\$19<sup>95</sup> net**  
Fully Guaranteed

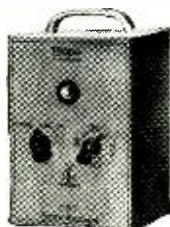

**CRT TESTER-SPARKER:**

**Picture Tube Sparker**: Sparks out electrical leakage between elements. Saves many picture tubes and small tubes which would usually be discarded. Cathode-grid leakage is an especially common occurrence. The **Sparker** corrects this very quickly. The **Sparker** also gives a rapid check of gas condition of the tube.  
**TESTER**: A variable 8,000-14,000 DC supply, useful for analyzing hard-to-solve deflection problems. Fully Guaranteed.

2 Instruments in One  
Ideal for Labs, too

**\$19<sup>95</sup> net.**

**CRT TESTER-REACTIVATOR-SPARKER: 3 in 1**

A combination of the **Tester-Reactivator** and **Tester-Sparker** in one handy instrument. It does not have the variable 8,000-14,000 D.C. supply included in the **Tester-Sparker** and therefore cannot be used for sweep circuit analysis. However, it performs all the other functions: **Tests Picture Tubes; Reactivates Dim Tubes; Sparks out Electrical Leakage in Picture Tubes.** A compact, profitable 3-in-1 Service Instrument. Fully Guaranteed.

**\$34<sup>95</sup> net**

**FIELD STRENGTH METER—  
A GREAT BUY at NEW LOW PRICE**

Improve TV installations: save half the work with the Transvision Field Strength Meter. Especially good for fringe areas—measures field strength as low as 10 microvolts. Model FSM-1, complete with tubes. **\$59 net**



Improve your business—order these instruments now—direct from  
**TRANSVISION, INC., Dept. RE-10, NEW ROCHELLE, N.Y.**

**CRYSTAL-CONTROLLED CONVERTER**

? Please print a diagram of a crystal controlled converter to enable me to tune from 5 to 8 mc on my automobile receiver. I would like the circuit to include a stage of r.f. amplification.—  
F. R., Vicksburg, Miss.

A. It is impossible to cover the band width you want with a broadcast receiver. When the oscillator of a shortwave converter is crystal controlled or cannot be controlled from the front panel, the tunable circuits of the receiver (the antenna, oscillator, and mixer grid circuits) are used as a tunable first i.f. of a double superheterodyne. The bandwidth of the shortwave band is equal to the bandwidth of the tunable i.f. amplifier. This is equal to F1 minus F2, where F1 is the highest frequency covered by the receiver on the band used for tuning and F2 is the lowest frequency in the band. Thus, if the receiver tunes from 550 to 1650 kc, the bandwidth of the shortwave range is 1,650 - 550, or 1,100 kc. With 5 mc as the lowest frequency in the shortwave band, the highest frequency that can be tuned without changing the oscillator frequency is 5,000 plus 1,100 or 6,100 kc.

Keeping in mind that the shortwave bandwidth equals the bandwidth of the first i.f., we find the desired oscillator frequency for any desired section of the shortwave band equals F3 - F4 or F5 - F6; where F3 is the lowest shortwave frequency, F4 is the lowest frequency in the tunable i.f., F5 is the highest frequency in the shortwave band, and F6 is the highest frequency in the tunable i.f.

**MOBILE ANTENNA QUERY**

? Recently, I mounted a 10-meter whip antenna on my car as the first step in the installation of a complete 10-meter mobile station. The antenna was mounted on the rear bumper and connected to the broadcast receiver with RG-59/U coaxial cable. When I try to use the whip, the receiver sensitivity is far below that when the short cowl-mounted antenna is used. I cannot peak the signal from the whip with the antenna trimmer on the set. Can you tell me what causes this loss of signal? How can I get normal signal strength from the whip antenna?—E. S. K., Bronx, N. Y.

A. The decrease in sensitivity is caused by the shunt capacitance of the

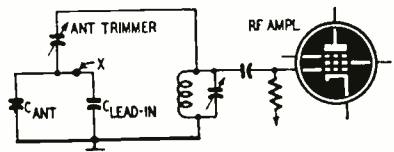

lead-in. The front end of an automobile radio is designed so the antenna trimmer can adjust the total stray capacitance across the tuned coil to the value which permits the circuit to track properly.

The diagram shows the antenna-to-  
RADIO-ELECTRONICS



ground capacitance  $C_{ant}$  and lead-in capacitance  $C_{lead-in}$  in series with the antenna trimmer across the antenna coil. The capacitance range of the trimmer is selected to compensate for nominal values of antenna and lead-in capacitance resulting from using a standard automobile broadcast antenna and two or three feet of lead-in. Using a longer antenna and a dozen or so feet of coax increases the stray capacitance values to the point where the antenna trimmer cannot compensate for them. This makes it impossible to resonate the antenna circuit of the receiver and causes a loss of sensitivity.

You can compensate for the added stray capacitance by connecting a small ceramic or mica capacitor (about 200  $\mu\text{f}$ ) in series with the lead-in at the receiver's antenna input terminal. This is equivalent to connecting the capacitor at point X in series with the lead-in capacitance. The added capacitor reduces the lead-in capacitance because it is effectively in series with it.

**PHOTOELECTRIC RELAY**

? Please print a circuit of a photoelectric relay which can be arranged to open or close an external circuit when light is temporarily shut off from the phototube. I would like to have the simplest circuit that will provide reliable operation from 117-volt a.c. or d.c. lines.—W. W. W., Bronx, N. Y.

A. This circuit can be used with a variety of tube types on a.c. or d.c. lines. The circuit is self-rectifying so it does not require a d.c. supply for the plate

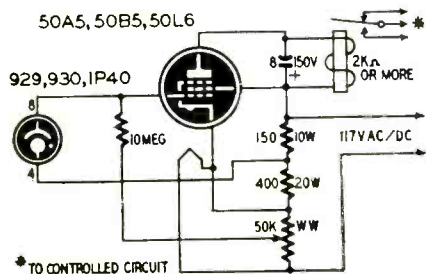

and screen of the relay tube. The 50,000-ohm resistor controls the sensitivity. The s.p.d.t. relay makes it easy to make or break the external circuit simply by selecting the proper relay contacts. END

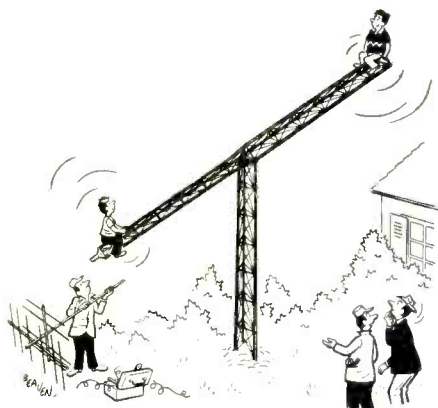

"I just turned my back for a minute, boss!"

**TV DIRECT FROM THIS GREAT FACTORY TO YOU**  
BRINGS YOU  
**Finest Quality at Lowest Prices**



**TRANSVISION**  
**TV KITS, WIRED CHASSIS, and SETS**  
CABINETS, COMPONENTS, INSTRUMENTS, and ACCESSORIES  
**NEW LOW PRICES**

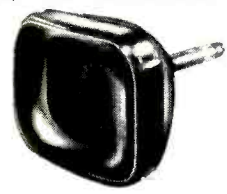

on Top Quality TV Picture Tubes:

- **TRADE-IN ALLOWANCE**  
Make from \$2.00 to \$5.00 glass allowance on each "dud."
- **FULL 2 YR. GUARANTEE:**  
Only Transvision gives you a Guarantee for 24 months.

**FREE BOOKLET:** "INSIDE CRT, or What You Should Know About Picture Tubes." Written by CRT experts, illustrated. It will MAKE MONEY FOR YOU. WRITE FOR IT NOW.

**FREE CHART:** Write for Picture Tube Interchangeability Chart.

**COMPARE:** Get the full details on the Transvision tube deal today.

New... TRANSVISION Picture Tube PRICES

Tube Type	Cost, WITH GLASS allowance	Cost, WITHOUT GLASS allowance
10BP4	\$11.80	\$13.80
12 1/2" Glass (any type)	13.45	15.75
12 1/2" Metal (any type)	13.95	16.25
14RP4	16.50	18.25
16" Metal (any type)	19.90	23.20
16" Round or Rect. (any type)	18.90	22.25
17BP4	18.90	22.25
19" Metal or Glass (any type)	23.95	28.95
20CP4	26.95	31.95

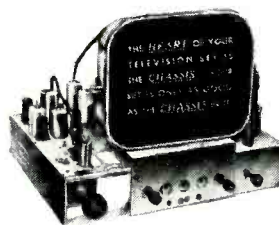

Sensational Offer:

**TV \$39 DOWN\***  
**KITS**

Build World's Finest Chassis—the A4

\***BUILD THE FINEST CHASSIS MONEY CAN BUY** with the famous A4 Kit by Transvision. **PAY AS YOU WIRE**—only \$39 for the starting package. Easy to assemble, enjoyable, educational—gets you the most superb TV set imaginable. Easiest to service, too. Don't put it off. With these easy terms you can get started now. Also **WIRED CHASSIS at LOW COST.** The A4 in completely wired chassis form gives you the world's finest TV set, with latest circuits and extra sensitivity for fringe areas. Gives clearer, brighter picture. Easy to service and keep up to date; built to last for years. Write for amazing low prices.

**SIZES:** The A4 Kit and Wired Chassis are available in 17" and 20" sizes. Also with **REMOTE CONTROL.**

**BEAUTIFUL TV CONSOLES**

Ideal for Custom-Building or Conversion. Factory prices start from \$49. Send for Cabinet Catalog now.



**MULTI-SET CONNECTORS**

feed up to 5 TV Sets from 1 Antenna  
Prices: Multi-Set Conn. for 2 sets \$4.95 list\*  
For 3 or 4 sets 7.95 list\*

\*Dealers, write for discounts

**U. H. F. ADAPTERS**

will be available for all Transvision Sets and Kits.

Write for Transvision's Factory Agent Plan and complete literature

**FREE: EXTRA INCOME EVERY MONTH** from hints in "TV and Electronics Notes." Request or send 50c to cover cost of sample copy, addressograph plate and mailing for **FREE** Subscription. Monthly issues are gold mines of info on New Products, Sales, Service, Conversion, etc. **WRITE DEPT. RE-10 TODAY!**

**TRANSVISION, INC. NEW ROCHELLE, N. Y.**



# Compare!

PROVE  
**EMC**  
SUPERIORITY!

**MODEL 205**

**tube tester**  
• Tests all tubes including Noval and sub-miniatures  
• Completely flexible lever type switching arrangement • Tests all tubes from .75 volts to 117 filament volts by standard emission test • Tests all cold cathode, magic eye, voltage regulator and ballast tubes • Has pilot light indicator • Line voltage control compensates for line variations between 105 and 135 volts • Checks for shorts and leakages • Three-color hammer-tone panel



**MODEL 205C—**  
Sloping Counter Case—illustrated . \$46.50  
**MODEL 205P—**  
With hand-rubbed oak carrying case . \$47.50

**MODEL 204**

**tube-battery-ohm capacity tester**  
Tests all tubes including Noval and sub-miniature • Tests all batteries under rated load • Emission testing method gives easy, direct readings • Tests resistance to 4 megohms • Tests condensers from .01 to 1 mfd • Uses four-position lever type switches • Checks condenser leakage



**MODEL 204—**  
Portable oak case, removable cover . \$55.90

**MODEL 206**

**Mutual conductance tube tester**  
• Checks mutual conductance on calibrated microhmo scale  
• Checks tubes for gas content • Detects both shorted and open elements  
• Tests all tubes from .75v to 117 filament volts  
• Tests all loctal, octal and miniature tubes • Checks individual sections of multi-purpose tubes. Built-in roll chart. Uses lever type switches.



**MODEL 206—** Sloping Counter Case . \$79.50  
**MODEL 206P—**  
With hand-rubbed oak carrying case . \$83.50  
Write Dept. RE-10 for FREE Catalog

**EMC** Electronic Measurements Corp.  
280 Lafayette St., New York 12, N. Y.  
Export Dept. 101 W. 47th St. N. Y. C.

**SERVICE TECHNICIANS**

What was your most unusual service case? Not necessarily the most difficult one, but the one you will remember longest, either because of the problem itself or because of other conditions surrounding the job. If the experience was interesting to you, it probably will be to other readers of RADIO-ELECTRONICS. We will pay \$10 for each "My Most Unusual Service Job" item we consider outstanding enough to publish in this magazine. If the item is striking enough or carries sufficient technical information to be worth more than \$10 in our opinion, it will be paid for at our regular space rates. Address your stories to

Unusual Service Job  
RADIO-ELECTRONICS  
25 West Broadway  
New York 7, N. Y.

Dr. C. J. Breitwieser was promoted to director of engineering at P. R. MAL-LORY & Co., Indianapolis. Dr. Breitwieser was executive assistant to Dr. F. R. Hensel, vice-president in charge



C. J. Breitwieser

of engineering. In his new position he will direct the company's central research laboratories and general engineering staff and will assume responsibility for divisional engineering departments.

Oden F. Jester joined STANDARD COIL PRODUCTS Co., INC., Chicago, as sales manager of the distributor division. Mr. Jester was vice-president of the Meissner-Thordarson-Radiart Division of Maguire Industries, and for a number of years was general sales manager of Utah Radio Products Co.



O. F. Jester

Dr Yuen T. Lo joined CHANNEL MASTER CORP., Ellenville, N. Y., as project engineer of the Antenna Development Laboratory. Dr. Lo has done extensive work in electronic research. In his new position he will carry on advanced development work in electronics and antennas.



Y. T. Lo

Dr Ben Kievet was promoted to manager of sales engineering for the Radio & Television Picture Tube Divisions of SYLVANIA ELECTRIC PRODUCTS, INC. He was formerly field engineer for the Equipment Tube Sales Department.



B. Kievet

Rudolph Sachs joined HYTRON RADIO & ELECTRONICS Co., a division of Columbia Broadcasting System, Danvers, Mass., as manager for semiconductor products. Sachs had considerable engineering experience with germanium and silicon diodes and transistors with Western Electric Co. and another pioneer in the semiconductor field.



R. Sachs



S. B. Schiffman

**The New TELE-MATIC TWO-SET COUPLER**

**TOP PERFORMANCE . . . LOWEST COST**

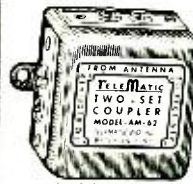

The Mini-Coupler outperforms couplers selling at many times its price!  
**Only \$3.50 List**  
(full trade discount)

- 2-stage transformer (inductive coupling)
- Compact, 2" x 2" x 1 1/2", fits anywhere
- Screw Terminals
- Minimum inter-set coupling
- No dummy load required for single-set operation

Available at Leading Jobbers  
Send for FREE booklet on TV INTERFERENCE



ONE JORALEMON ST. BROOKLYN 2, N. Y.

**NOW—Get this expert SELF-TRAINING in RADIO SERVICING**

by ABRAHAM MARCUS

co-author of famous "Elements of Radio" which has sold over 800,000 copies!

Here is every detail you need to know about radio repair, replacement, and readjustment. Easy-to-understand, step-by-step self-training handbook shows you how to locate and remedy defects quickly.

Covers: TRF Receivers; Superheterodyne Receivers; Short-Wave Receivers and Converters; Multiband Receivers; Portable Receivers; Automobile Receivers; Communication Receivers; E-M Receivers; Power Supplies operated from AC; DC, Batteries, Motor Generators, etc.

Tells you the HOW and WHY of: **Electron Tubes** (Diode, Triode, Pentode, Beam Power, Thyatron, Phototube, Cathode Ray, etc.); **Rectifier Circuits** (Half-wave, Full-wave Bridge, Voltage-Doubler, etc.); **Detector Circuits** (Diode, Triode, Regenerative Superregenerative, Infinite-Impedance, etc.); **Amplifier Circuits** (Audio, Radio, I-F, Video, D-C, etc.); **Oscillator Circuits** (Hartley, Colpitts, Crystal, Transitron, Multivibrator, Sweep-circuit, etc.); **Control Circuits** (Volume, AVC, DAVC, Tone, Noise-Suppression, Automatic Tuning, Automatic Frequency Control, etc.).

Explains how to use **testing instruments** such as meter, vacuum-tube voltmeters, ohmmeters, bridges, multimeters, signal generators, tube checkers, cathode-ray oscilloscopes, etc. Over 100 pages and 69 illustrations in this section alone!

Get this authoritative radio repair handbook today! Coupon below brings you "Radio Servicing" on FREE trial for 10 days. Mail it NOW.

PRENTICE-HALL, Inc., Dept. M-RE-1052  
70 Fifth Ave., New York 11, N. Y.

Send me, for 10 DAYS' FREE TRIAL "Radio Servicing," by Abraham Marcus. I will return it in ten days and pay nothing—or keep it and send \$1.95 down (plus postage) and \$2 monthly for 2 months.

Name .....

Address .....

City ..... State .....

( ) SAVE! Send \$5.95 WITH COUPON—we pay postage.



Stanley B. Schiffman was appointed manager of the Field Liaison Division of JOHN F. RIDER PUBLISHER, INC., New York City. Mr. Schiffman has been active in public relations, sales, and engineering in the electronics field.

**Personnel Notes**

... Daniel D. Halpin was appointed general sales manager of the Receiver Division of ALLEN B. DU MONT LABORATORIES. He succeeds Walter L. Stickel, who resigned to become national sales manager of Hoffman Radio, Los Angeles. Halpin was formerly with RCA.

... George E. Mobus joined MOSLEY ELECTRONICS, Overland, Mo., as head of the newly formed Advertising and Sales Promotion Department. He came to the company from the Bartz Advertising Agency, Peoria, Ill., which handles the Mosley account.

... Ken Burcaw, who had been sales manager of Cornell-Dubilier Electric Corp. and Radiart, formed his own sales organization, K. C. BURCAW & Co., with offices in Detroit, Mich., and East Palestine, Ohio.

... Lou Selsor, former sales manager of National Video, joined the distributor sales staff of JENSEN MANUFACTURING Co., Chicago. P. B. Williams, who had been in charge of Jensen transducer developments, was promoted to chief engineer, and Harry E. Allen, former senior engineer, was named manager of the Government Product Division.

... John Laura was appointed Western branch manager of RADIO MERCHANDISE SALES (RMS), New York City, manufacturer of TV antennas and electronic accessories. A veteran in the radio field, Mr. Laura is organizing the operation of the new RMS West Coast branch in Los Angeles.

... James McA. Krampf was promoted to sales manager of the HI-Q Division of AEROVOX CORP., Olean, N. Y. He was formerly assistant sales manager.

... V. S. Mameyeff, former manager of export activities for RAYTHEON MANUFACTURING Co., Waltham, Mass., was promoted to manager of the International Division. Raytheon also announced the transfer of George J. Zipf, former sales engineer for the New York district, to district manager of sales and service for the Chicago district.

... Robert Adelson, New York attorney, joined the legal staff of SYLVANIA ELECTRIC PRODUCTS, INC.

... J. B. Ferguson, formerly of Link Radio Corp., joined PLATT MANUFACTURING CORP., New York City, as chief engineer in charge of engineering.

... Howard S. Moncton was named administrative engineer of the Radio and Television Division of SYLVANIA ELECTRIC PRODUCTS, INC. Irwin Goldman, senior engineer, succeeds Moncton as assistant to the manager of the Physics Laboratories, Bayside, N. Y.

... Irving W. Romm, manager of the Special Order Division of the INSULINE CORP. OF AMERICA, Long Island City, N. Y., was honored by Insuline executives and co-workers on the occasion of his 25th anniversary with the company. END

# SERVICEMEN!

## Have You Entered

### THE BIG

# Jensen

# \$5,000.00

## Cash Prize Contest?

---

SEE YOUR *Jensen* NEEDLE DISTRIBUTOR  
TODAY FOR DETAILS AND ENTRY BLANKS.

**PLEASE MENTION  
RADIO-ELECTRONICS  
WHEN WRITING ADVERTISERS**

**OPPORTUNITY AD-LETS**  
Rates—37¢ per word (including name, address and initials). Minimum ad 19 words. Cash must accompany all ads except those placed by accredited agencies. Discount for 6 issues, 10%; for 12 issues, 20%. Misleading ads not accepted. Copy for December issue must reach us before October 21, 1952.  
Radio-Electronics, 25 W. Broadway, New York 7, N. Y.

**SPEAKERS REPAIRED** at wholesale prices. Guaranteed workmanship. Fast service. Amprite Speakers Service, 70 Vesey St., New York 7, N. Y.

**USED CORRESPONDENCE COURSES AND Educational Books**, Bought, Sold, Rented. Catalog Free. Educational Exchange, Summerville, Ga.

**WE REPAIR, CONVERT, SELL ALL TYPES OF electrical instruments, tube checkers and analyzers.** Hazleton Instrument Co. (Electric Meter Laboratory), 128 Liberty Street, New York, N. Y. Telephone: BARclay 7-4239

**WANTED: AN "APR", other "APR", "TS", "415", "ARC-1", "ARC-3", "ARP-13", "R-318", etc.** Microwave Equipment, everything Surplus, Special Tubes, Tee Manly, Lab Quality Equipment, Meters, Fast Action, Fair Treatment, Top Dollar! Littell, Parhills Box 26, Dayton 9, Ohio.

**NEW RCA 3AP1A ORIGINAL CARTONS \$6.75 EACH** Tubes, surplus-bought, sold. Free list. Write MARK, Box 14, New York City 72.

**BUY WHOLESALE—25,000 ITEMS—CATALOG 25¢** Matthews, 1172-P1 Broadway, N. Y. C. 36.

**FIVE ELEMENT TV YAGI BEAMS, ALUMINUM Tubing, etc.** Write for prices, Willard Radloff, Fostoria, Ohio.

**WANTED: ALL TYPES OF RECEIVING AND TRANSMITTING** tubes, Surplus Receivers, and Transmitters, Williams Electronics Co., 168 Washington Street, N. Y. C.

**TV AND FM ANTENNAS, YAGI, CONICAL, ROW-TIE** Mounts, accessories. Lowest prices. Wholesale Supply Co., Lunenburg 2, Mass.

**ENJOY 3 COLOR TELEVISION SCREEN. SEND \$1.** State Screen Size. Zingo Products, Dept. K, Johnstown, New York.



## EVERY RADIOMAN Can Use These SERVICE HINTS!

**Valuable Manual Yours—FREE!**



Every page of "How to Simplify Radio Repairs" is packed with on-the-bench, practical ideas. Contains photos, charts, diagrams—no fluff—no vague theory. If plain, every-day language it gives you priceless suggestions—new servicing ideas. You'll use and benefit from the experience of experts. Partial list of contents: How to Localize Trouble; How to Test Speakers; How to Test for Distortion; How to Test Audio Circuits; How to Test Stokers; How to Find Faults in Oscillators; How to Test Radio Parts—and it's all yours—FREE! No obligation.



**SEND COUPON OR GOVERNMENT POSTCARD FOR YOUR FREE COPY TODAY!**

**FEILER ENGINEERING CO., Dept. 10RC2**  
8026 N. Monticello Ave.,  
Skokie, Ill. (Suburb of Chicago)  
Please RUSH my FREE copy of "How to Simplify Radio Repairs."

Name.....  
Address.....  
City.....Zone.....State.....



Available from stock  
at TRIAD  
jobbers!

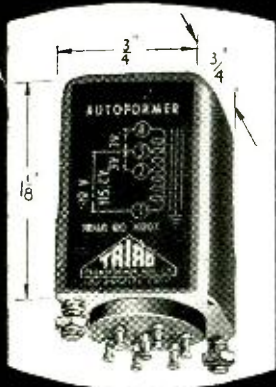

"The World's Smallest  
Hermetically Sealed  
Transformer"

Miniaturization has become increasingly important in the design of all types of electronic equipment. Use of improved core materials and better winding techniques in our JAF series permits these great reductions in size and weight of low level audio-transformers. TRIAD JAF Transformers, as listed below, are "the world's smallest hermetically sealed transformers." All have 45 db. shielding and are available in MIL standard AF case as shown above. Carried as stock items at all Triad jobbers.

Type No.	Impedance		Req. Resp.	List Price
	Primary	Secondary		
JAF-1	600/250/50	50000	100-10000	\$14.50
JAF-2	600/250/50	250000	300-3000	15.30
JAF-3	600/250/50	60000 C.T.	100-10000	15.30
JAF-11	15000	50000	100-10000	13.60
JAF-12	15000	60000 C.T.	100-10000	14.50
*JAF-13	15000	95000 C.T.	350-5000	15.30
JAF-21	15000	600/250/50	100-10000	14.50
*JAF-22	15000	600/250/50	350-5000	14.50
JAF-23	20000 C.T.	600/250/50	100-10000	15.30
JAF-31	600/250/50	600/250/50	100-10000	14.50
JAF-101	50 h.-1 Ma.			11.60

Maximum level +10 dbm. \*DC in primary, except JAF-1, 2 and 3 (0 dbm.)

Write for Catalog TR-52B

Plant, General Offices: 4055 Redwood Ave. Venice, Calif.  
Address correspondence to: Box 17813 Los Angeles 34, Calif.

RCA 4QV8C COMBINATIONS

Because of the scarcity of type 6SF7 tubes, it was necessary to substitute a 6SK7 and a germanium diode in the model 4QV8C and similar sets. The 6SF7 is a diode-r.f. pentode used as the detector and i.f. amplifier in chassis

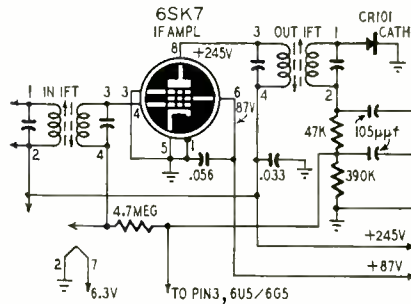

stamped RC 620A. The diagram shows the circuit of the 6SK7 and detector diode used in the RC 620D chassis.—RCA Service Bulletin.

TELE-TONE MODEL 249

A number of these sets come in with the complaint that picture height has decreased to only 2 or 3 inches. This is usually caused by the 1.5-megohm resistor in series with the height control. It may change in value to as low as 500,000 ohms or it may open up. In either case, replace it with a 1.5-megohm, 1-watt unit.—Martin Rosenberg

CORONA AT SECOND ANODE

Certain types of rubber anode caps gradually become conductive due to a chemical decomposition of the rubber. This produces a leakage path across the insulated area of the glass around the anode button and often results in corona or arcing problems. Ordinarily, wiping the glass under the rubber cap does not remove the deposit that results from the decomposition of the rubber.

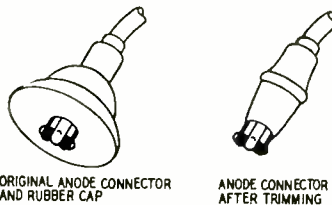

The suggested cure for this condition is to trim off the flange portion of the rubber cap to a point where no rubber touches the glass. This will leave only the sleeve portion of the cap which serves as a support for the lead into the connector.

Clean the glass around the anode button with water and a scouring compound such as Bon Ami. The area around the anode button should be scoured and then thoroughly dried and polished with a clean dry cloth so that no residue remains. If the above instructions are carried out, no further trouble of this nature should be experienced. The drawings show the anode connector before and after trimming.—Crosley Service Bulletin

AIR TRIMMERS



Capacity	Max.	Fig.	Shaft Length	Post Length
2	12	D	5 1/16"	3 3/32"
2	27	A	1 1/2"	3 3/32"
3	10	D	5 1/16"	3 3/32"
2	18	A	5 1/16"	1 1/4"
4	25	A	17 3/32"	3 3/32"
5	30	A	1 1/2"	3 3/32"
5	55	A	1 1/2"	3 3/32"
7	28	A	5 1/16"	3 3/32"
7	85	D	5 1/16"	3 3/32"
H	45	A	17 3/32"	3 3/32"

PRICE, EACH 47c

Fig. A: Round Shaft, Screwdriver Adj. w Locknut. Fig. C: Rd. Shaft, Screwdriver Adj. Fig. D: Hexnut Screwdriver Adj.

RECTIFIER TRANSFORMERS

Pri: 115V. 60 Cy. Sec: 28V 3.1A, 26V 8.4A	\$17.95
7.3V 14A	
Pri: 210/215 220 225 230 235 240V. 60 Cy. 1 Phase	\$19.95
Sec: 11 10 7.5 5VCT @ 35A	
Pri: 115V 60 Cy. Sec: 20V @ 10A	3.95
Pri: 115V 60 Cy. Sec: 8.1V @ 1.5A	1.39

UNIVERSAL SUPPLY KIT

Delivers 230V @ 40MA DC. From 110 220VAC 60 Cy. Kit Consists of 1-ttx Transformer, 1-5 Hy @ 40MA Choke, 2-8MFD @ 450V Filter Cond. 1-6X5 Tube. A great buy at only 3.95

INTERPHONE TRANSFORMER SET

Rig your own interphone. Kit consist of 1-Input Transformer (Matches 4 or 6 OHM SPKR to Grid) and 1-Output Transformer (Matches 50L6, 35L6, 25L6 etc. to 4 or 6 OHM Speaker Set of 2 XFMRS. ONLY 1.00



BC 605 INTERCOM

Easily converted to an ideal inter-Communications set for office, home, or factory. Original, New w conversion. Diagram \$4.75 = 606 Control Boxes.

Send M. O. or Check. Shipping Chgs. C.O.D. COMMUNICATIONS EQUIPMENT CO. 131 Liberty St. Dept. C-10 New York City 7, N. Y.

OSCILLOSCOPES ARE "GOLD MINES"!

... if you learn how to use them fully on all types of service jobs!



Learn to handle the oscilloscope fully on all types of AM, FM and TV service work—and watch your efficiency and earnings soar!

MODERN OSCILLOSCOPES AND THEIR USES, a fact-jammed 326-page book by Jacob H. Ruiter, Jr., of the Allen B. DuMont Laboratories, contains exactly the help you need—written in a way you can clearly understand. It shows you how to use your scope for fast accurate work on all types of jobs from troubleshooting to realigning; how to make connections; how to adjust circuit components; how to set controls and how to analyze patterns fast and accurately. 370 helpful illustrations including dozens of pattern photos make things doubly clear.

No other type of specific service training stands to mean so much to you in terms of being able to do better, faster and more profitable work!

- ✓ When, where, why and exactly how to use your oscilloscope
- ✓ How to interpret patterns
- ✓ How to handle tough jobs in less time

MAIL ORDER 10-DAY FREE EXAMINATION

Dept. RE-102, RINEHART BOOKS, Inc. Technical Division, 232 Madison Ave., New York 16, N. Y. Send MODERN OSCILLOSCOPES AND THEIR USES for 10-DAY EXAMINATION. If I decide to keep the book, I will then remit \$6.00 plus a few cents postage in full payment. If not, I will return book post-paid and owe you nothing.

Name \_\_\_\_\_  
Address \_\_\_\_\_  
City, Zone State \_\_\_\_\_  
Employer's Name & Address \_\_\_\_\_  
Money back if book is returned in 10 days.



**PICTURE WASHOUT**

In some late Philco dual-chassis receivers, the black parts of the picture turn gray if the contrast control is advanced beyond a point near the maximum gain position. This condition, called washout, is caused by overloading in some part of the video section of the set. If washout is accompanied by sync instability, the overloading is ahead of the sync take-off point. If sync stability is not affected, the overloading is taking place at some point in the circuit between the sync take-off and the input to the picture tube.

Three circuit changes are recommended as a cure for overloading in stages following the sync take-off. The diagram at *a* shows the original circuit and the modified circuit is shown at *b*. In the original circuit, the screen of the 6AQ5 video output stage was supplied from the B plus line to the i.f. amplifiers. To provide a higher screen voltage and thus prevent overloading, the 5,600-ohm resistor in the plate circuit of the first video amplifier is shunted by a 12,000-ohm unit and the output tube screen connection moved to the low-voltage side of these resistors. Opera-

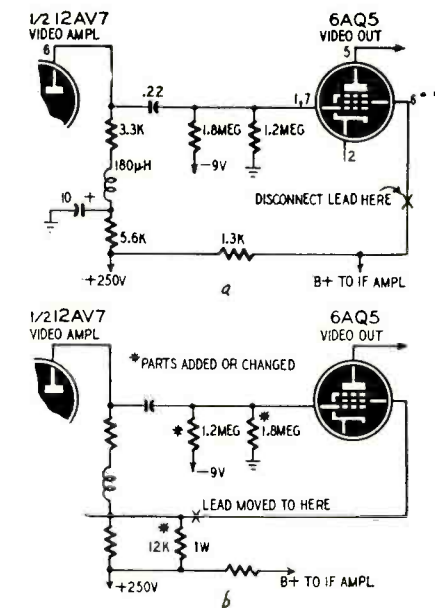

tion of the output stage is further improved by interchanging the 1.2- and 1.8-megohm grid resistors. This change increases the grid bias, thus permitting the output stage to handle higher sig-

nal voltages without overloading.—  
*Philco Service Bulletin*

**DU MONT RA-160**

Complaints of vertical sync drift and erratic operation of the vertical oscillator in the RA-160 may be caused by overheating in the 6BL7-GT vertical oscillator and output tube when a shield is used over it. This shield should be removed when the set is installed. If vertical drift persists after the 6BL7 has been allowed to cool, replace the tube and leave the shield off.—  
*Du Mont Service News*

**RCA KCS66 AND KCS68 CHASSIS**

If the picture is weak and smeared, check the plate resistor of the video amplifier (6,000 ohms in the KCS66 and 6,700 ohms in the KCS68). These wire-wound resistors frequently open up or increase in value enough to cause this condition.

If the a.g.c. control cuts off the sound and picture when turned to the extreme counterclockwise position, check the 100-µmf bypass capacitor (C222) for leakage. This capacitor is in the screen circuit of the video amplifier.—  
*C. W. May*      **END**

# New 1953

# DIAMOND ARRAY

## DOUBLE-STACKED TV ANTENNA

### SENSATIONAL RECEPTION

**GOOD, CLEAR, SHARP PICTURES**  
from  
**150 MILES and MORE!**

Designed For All Channels...  
UHF-VHF

**INSTANT ASSEMBLY!**

**8 Ft. WIDE**  
**4 Ft. HIGH**  
4 Conical Diamond Dipoles Double-stacked

*Your Cost Only*

# \$8<sup>70</sup>

**AS ILLUSTRATED**

**DIRECT From MANUFACTURER!**

**LOTS OF 6 \$8.25 EACH**

Add 60¢ for postage

Shipped anywhere in U.S.A. 20% Deposit on all C.O.D. orders.

**IMMEDIATE DELIVERY!**

WRITE . . . WIRE or CALL

# RAY CO.

**441 SUMMIT ST., TOLEDO, OHIO**

A TREMENDOUS VALUE! A record breaker from the word "go" . . . proven long-distance reception at an unbelievably low price. It's designed not only for TV stations now in operation, but also for new stations to come. Just look at the construction! Unbreakable aluminum elements, 4 conical diamond dipoles . . . double-stacked and aircraft-type plexiglass insulators. 8 ft. wide and 4 ft. high. Matches any ohm wire. Don't wait! Send for yours today!

THE FUND NEARS \$10,000



**HELP-FREDDIE-WALK FUND**

We at RADIO-ELECTRONICS continue to receive encouraging reports from Herschel Thomason, radio technician of Magnolia, Arkansas, on the progress of his little four-year-old son, Freddie, who, as many of our readers know, was unfortunately born without arms or legs. Having just been fitted with a new pair of legs, he is adjusting himself to them rapidly, and even when the going gets tough, plucky Freddie refuses to be without them.

This is not the first pair of legs that Freddie has had—nor will it be the last. Like all youngsters, his rate of growth is rapid, and of course his legs must "grow" with him. We can all realize the tremendous sum of money involved in such an undertaking, and it was with this thought in mind that RADIO-ELECTRONICS inaugurated the Help-Freddie-Walk Fund some three years ago. The Fund is now nearing the \$10,000 mark, but its work is merely beginning; for literally thousands more dollars will be needed before we can be assured that we have done all that we can to help Freddie attain his rightful place in society.

But it is a task that cannot be handled by ten, twenty, or even one hundred of us. Its scope is so great that we have asked each and every reader to do what he can to back up the faith and diligence of Freddie's parents, who have never lost sight of the original goal—a "normal" life for their son. Thousands have responded, and each day's mail brings letters from new friends and old.

Won't you please send in your contributions whenever and as often as you can? No amount is too small to receive our acknowledgment and sincere thanks for the part you are playing in this worthy cause. *Make all checks, money orders, etc., payable to Herschel Thomason.* Address all letters to:

HELP-FREDDIE-WALK FUND  
c/o RADIO-ELECTRONICS Magazine  
25 West Broadway  
New York 7, New York

**FAMILY CIRCLE CONTRIBUTIONS**

Balance as of July 18, 1952 ..... \$ 558.50  
Anonymous, Ocean City, N. J. .... 1.00  
Mrs. Harry Blaver, Glendale, Calif. .... 2.00

FAMILY CIRCLE Contributions as of August 21, 1952 ..... \$ 561.50

**RADIO-ELECTRONICS CONTRIBUTIONS**

Balance as of July 18, 1952 ..... \$9,312.26  
Anonymous, Elmwood Park, Ill. .... 2.00  
Anonymous, Pala, Calif. .... 1.00  
Anonymous, Portsmouth, Va. .... 10.00  
Anonymous, St. Louis, Mo. .... 5.00

RADIO-ELECTRONICS

**TECH-MASTER TV KITS**

More Leading ENGINEERS and TECHNICIANS Choose

C. G. McProud, Editor of AUDIO Engineering, writes, "I was amazed with the speed and simplicity... friends marvelled at the picture quality..."

**TECH-MASTER Advanced 630-Type Circuit**

World's Finest TV Kit—For all tubes from 16" to 24" • Advanced standard TURRET TUNER, adaptable to U.H.F. without tools • Cascade R.F. amplifier stage • Keyed AGC circuit • Full 4 Mc band width • "Hi-Sweep" voltage multiplier system • 3-stage synchronized amplifier • 3-stage video amplifier. Model 630D24-Deluxe, (all principal components mounted) ..... \$159.50  
Model 630S24-Standard, (unassembled) \$154.50  
Complete with all components, picture tube mounting brackets, speaker and all tubes (less Kine, wire and solder).



**TECH-MASTER Universal AC/DC KIT**

High quality TV now within reach of all. Advanced 12-channel TURRET TUNER adaptable to U.H.F. without tools • Latest type hi-gain stagger-tuned IF system • New AGC system • Maximum signal amplification, even in fringe areas • For 14" and 17" rectangular picture tubes. Model 5116: Complete with set of 16 circuit tested tubes, hardware, instructions and picture tube mounting brackets, (less Kine, wire and solder) ..... \$99.95



Sold by all leading Radio Parts Distributors.



Write for literature.

**TECH-MASTER PRODUCTS COMPANY**

443-445 BROADWAY, NEW YORK 13, N. Y.

Let MILTON S. KIVER Help You Prepare For U.H.F.-TV And...

**TELEVISION SERVICING**

Easy to TRAIN AT HOME This Practical Way!

Men with the right training in Television Servicing are in big demand... pull down big pay. T.C.I. TRAINS YOU RIGHT with easy-to-follow technical training designed by servicemen, for servicemen! You learn practical, professional type Television Servicing without leaving your present job. Included are money-making extras such as set conversion, master antenna installation. U.H.F.-TV and field servicing short cuts. You can start earning Television money after the first few lessons. You learn to test, trouble shoot and repair all types of TV sets the proven, practical way!

**HERE'S HOW YOU GET EXPERIENCE!**

You train on your own large screen modern television receiver, furnished as part of your course. This set is yours to keep! As an optional feature you can get two weeks of actual field experience out on service jobs and on the repair bench for Chicago's largest independent servicing organization. You learn Television Servicing by actually doing Television Servicing... you get the practical know-how you need to qualify for BIG MONEY in this fast-growing field! Age is no barrier. Many TCI students are over 40!

ACT NOW! Fill out and mail coupon for FREE Catalog and SAMPLE LESSON. Write TODAY!

**TELEVISION COMMUNICATIONS INSTITUTE**  
205 W. Wacker Dr., Dept. RE11, Chicago 6, Ill.

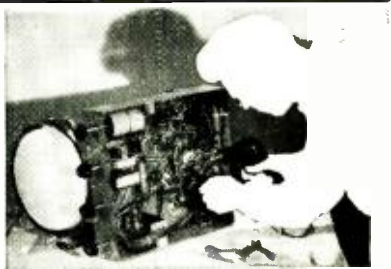

**YOU GET** and keep modern large screen Television receiver.

**YOU DO** actual testing, servicing, trouble shooting and repairing

**BROADCASTING COURSE READY NOW!**  
Train at home for these big pay studio jobs! Video engineers, cameramen, microwave engineers, etc. Easy non-mathematical training covers all phases. Write!

**MAIL NOW FOR FREE BOOKLET**

MILTON S. KIVER, President  
TELEVISION COMMUNICATIONS INSTITUTE  
205 W. Wacker Dr., Dept. RE-11, Chicago 6, Ill.

Rush full facts on the course checked below. I am not obligated. Salesman will not call.

TV Servicing  TV Broadcasting

Name ..... Age .....

Address .....

City ..... Zone ..... State .....

BEGINNERS check here for information on Pre-Telet Radio Course.



**BLAK-RAY SELF-FILTERING  
ULTRA VIOLET LAMP**

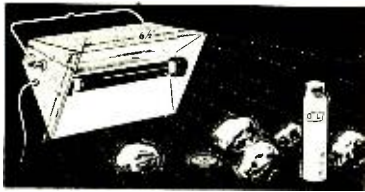

Experimenters have been looking for a reasonably priced Ultra-Violet lamp that would supply a rich quality radiation with minimum power consumption. The BLAK-RAY 4-watt lamp, model X-4, complete with U-V tube, fills these requirements admirably. Over 3000 substances are affected by the so-called "black light" and glow visibly or fluoresce in a weird manner when illuminated by the U-V lamp here illustrated. This lamp gives long-wave ultra-violet radiation having a wavelength of 3654 to 4000 angstrom units. Some of the substances made to fluoresce visibly when illuminated by U-V light are certain woods, oils, minerals, milkstone, cloth, paints, plastics, yarn, drugs, crayons, etc. This lamp is self-filtering and the invisible U-V rays are harmless to the eyes and skin. The lamp is equipped with spectral-finish aluminum reflector. The lamp consumes only 4 watts and can be plugged into any 110 volt 50-60 cycle alternating current outlet. Will give 2000 to 3000 hours of service. It weighs but 1 3/4 lbs. and has a convenient adjustable handle. The lamp is approved by the Underwriters Laboratories and has a built-in transformer so that it may be safely used for long periods when necessary. Extra U-V tubes are available at nominal cost. The outer casing of the lamp is richly finished and very sturdy.

Ship wt. 4 lbs.  
ITEM NO. 125  
UNUSUAL BUY ..... **\$14.75**

**POWERFUL ALL PURPOSE MOTOR**

Sturdy shaded pole A.C. induction motor. 15 watts, 3000 rpm. 3"x2"x1 1/4"; 4 mounting studs; 3/8" shaft, 3/16" diameter; 110-120 volts, 50-60 cycles, A.C. only. When geared down, this unit can operate an 18" turntable with a 200 lb. dead weight. Use it for fans, displays, timers and other purposes. Ship wt. 2 lbs.

ITEM NO. 147  
UNUSUAL BUY ..... **\$2.45**

**WATT HOUR METER**

Leading makes — completely overhauled, ready for service. 100-110 volts, 60 cycles, 2-wire A.C. 5 amp. Heavy metal case 8 1/4" x 6 1/4" x 5". Easy to install. Ship. wt. 14 lbs.

ITEM NO. 33  
NOW ONLY ..... **\$4.50**

**WESTERN ELECTRIC BREAST MIKE**

Lightweight 1 lb. carbon microphone. Aircraft type. Breastplate mounting, adjustable 2-way swivel. Easily fastened straps. For home broadcasts, communications etc. Complete with 6 foot cord, hard rubber plug. Shera-dized plate, non-rusting finish. Ship. wt. 2 lbs.

ITEM NO. 152  
NEW LOW PRICE ..... **\$1.75**

**AMAZING BLACK LIGHT**

250-watt ultra-violet light source. Makes fluorescent articles glow in the dark. Fits any lamp socket. For experimenting, entertaining, unusual lighting effects. Ship. wt. 2 lbs.

ITEM NO. 87  
A SAVING AT ..... **\$2.45**

**HUDSON SPECIALTIES CO.**  
40 West Broadway, Dept. RE-10-52  
New York 7, N. Y.

I am enclosing full remittance for items circled below. (Be sure to include shipping charges.)

OR, my deposit of \$..... Ship balance C.O.D.  
MINIMUM C.O.D. ORDER \$5.00.  
C.O.D. ORDERS ACCEPTED ONLY WITH 20% DEPOSIT  
INCLUDE SHIPPING CHARGES.

Circle Items Wanted  
87    147    33    152    125

Name.....  
Please Print Clearly

Address.....

City..... Zone..... State.....

Anonymous, San Jose, Calif. ....	3.00
Esther Brody, Chicago, Ill. ....	2.00
Harry Folk, Phila., Pa. ....	2.00
Herbert Goldstein, New York, N. Y.	5.00
Rafael Gonzalez, Buenavista, Marianao Cuba .....	3.00
Ivan Harrison, Dallas, Texas .....	2.00
Abe Kabakoff, Cincinnati, Ohio ....	3.00
M. Klein, Glassport, Pa. ....	5.00
Lt. & Mrs. Fred H. Lund & Frederick, Seattle, Wash. ....	1.00
Lowe Pharmacy, Tallahassee, Fla. :.	5.00
Tom Plumley, Wake Island .....	2.00
Alexander Rys, Minneapolis, Minn. .	1.00
Wilton Stone, Jr., Sanford, N. C. ...	2.00
Television Engineering Class T-16, Amer. Television Inst., Chicago, Ill.	8.00
W2PRI, Tonawanda, N. Y. ....	10.00
Allan Wallach, Winston-Salem, N. C.	5.00
Mrs. Thos. Watson, Erie, Pa. ....	1.00
William J. Zale, Antioch, Ill. ....	4.00

RADIO-ELECTRONICS Contributions  
as of August 21, 1952 ..... **\$9,394.26**

FAMILY CIRCLE Contributions .... **561.50**

TOTAL Contributions as of August  
21, 1952 ..... **\$9,955.76**

A radio-controlled life-raft of rubber, inflated with carbon-dioxide and housed in an aluminum-alloy cylinder which may be launched by plane or torpedo tube has been jointly developed by The United States Air Force Air Matériel Command and the Douglas Aircraft Company.

Using a remote-control radio system the launching plane or vessel will be able to start and stop the four-cylinder inboard engine and steer the raft to survivors on the sea. The raft has fuel for 300 miles of cruising, and is equipped with a two-way radio communication set, heating system, and automatic pilot.

**Radio Thirty-Five Years Ago**  
In Gernsback Publications

<b>HUGO CERNBACK Founder</b>	
Modern Electrics .....	1908
Wireless Association of America .....	1908
Electrical Experimenter .....	1913
Radio News .....	1919
Science & Invention .....	1920
Television .....	1927
Radio-Craft .....	1929
Short-Wave Craft .....	1930
Television News .....	1931

Some of the larger libraries still have copies of ELECTRICAL EXPERIMENTER on file for interested readers.

**October 1918  
ELECTRICAL EXPERIMENTER**

- The Automatic (Wireless) Soldier, by H. Gernsback
  - Tesla Has New Pointless Lightning Rod New Developments in Telephotography, by LeRoy J. Leishman
  - Original "Valves" Used by Dr. J. A. Fleming
  - An Unusual Type of Electron Relay New Developments in Radio Apparatus
  - Revolving Mirror and Spark Discharges, by Prof. Lindley Pyle, Washington University
  - The Einthoven Galvanometer, by Samuel D. Cohen
- END

**COMPLETE  
TRAINING  
FOR BETTER RADIO-TV  
SERVICE JOBS**



**ONLY  
\$12**  
for the  
complete  
2-volume  
course

**3 MONTHS TO PAY**

Let these two great new Ghirardi training books teach you to handle all types of AM, FM and TV service jobs by approved professional methods—and watch your efficiency and earnings soar!

Completely modern, profusely illustrated and written so you can easily understand every word, these books pave the way to fast, accurate service on any type of home radio-TV-electronic equipment ever made. Each book is brand new. Each contains the latest data on the latest methods and equipment—NOT a re-hash of old-out-of-date material. Each is co-authored by A. A. Ghirardi whose famous RADIO PHYSICS COURSE and MODERN RADIO SERVICING were, for 20 years, more widely used for military, school and home study training than any other books of their type!

**THE NEW Ghirardi  
RADIO-TV SERVICE LIBRARY**

Almost 1500 pages and over 800 clear illustrations show step-by-step how to handle every phase of modern troubleshooting and servicing.

**1—Radio and Television Receiver  
TROUBLESHOOTING & REPAIR**

A complete guide to profitable professional methods. For the novice, it is a comprehensive training course. For the experienced serviceman, it is a quick way to "brush up" on specific jobs, to develop improved techniques or to find fast answers to puzzling service problems. Includes invaluable "step-by-step" service charts. 820 pages, 417 illus., price separately \$6.75.

**2—Radio and Television Receiver  
CIRCUITRY AND OPERATION**

This 660-page volume is the ideal guide for servicemen who realize it pays to know what really makes modern radio-TV receivers "tick" and why. Gives a complete understanding of basic circuits and circuit variations; how to recognize them at a glance; how to eliminate guesswork and useless testing. 417 illus. Price separately \$6.

**New low price . . . easy terms**

If broken into new form and sent to you as a "course", you'd regard these two great books as a bargain at \$50 or more! Together, they form a complete modern servicing library to help you work faster and more profitably. Completely indexed so you can look up needed facts in a jiffy. Under this new offer, you save 75% on the price of the two books—and have the privilege of paying in easy installments while you use them! No lessons to wait for.

**10-DAY EXAMINATION PRIVILEGE**

Dept. RE-102, Rinehart Books, Inc.,  
Technical Division,  
232 Madison Ave., New York 16, N. Y.

Send me GHIRARDI'S NEW 2-VOL. SERVICE LIBRARY. I enclose \$3 as my first installment and will send you \$3 a month for three months until the total price of only \$12.00 plus a few cents postage is paid. It is understood I may read the books for 10 days. Then, if not satisfactory, I will return them postage paid and you agree to refund my \$3 and cancel the remaining installments. (Books shipped postpaid if full remittance accompanies order. Same return privilege.)

Name.....

Address.....

City, Zone, State.....

Employer's Name & Address.....

OUTSIDE U.S.A.—\$13.00 cash only. Same 10-day return privilege with money refunded.

## TRY CLAROSTAT'S RTV PROGRAM!

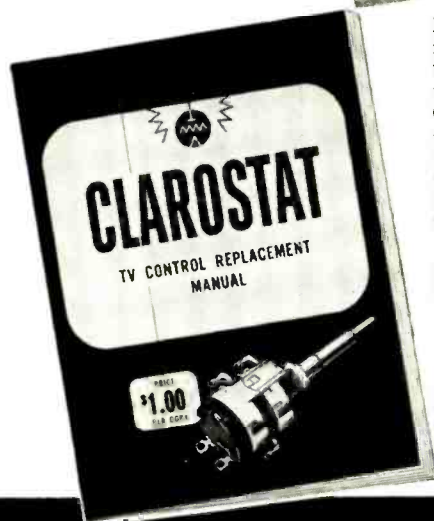
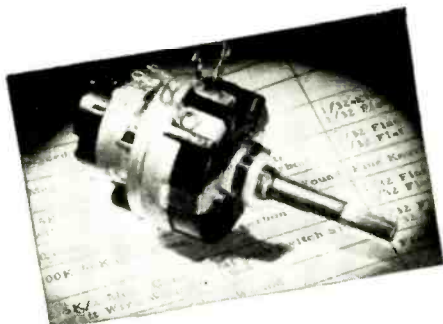

By all means, TRY IT! Because, when it comes to those tricky TV control replacements, you can save time, trouble, money and even reputation with Clarostat's RTV program. It means exact-duplicate replacements that positively match initial equipment. In many cases the RTV replacements cost less than any makeshift or "kit" assembly. Prove it for yourself.

And of course where standard controls, plus Ad-A-Switches and Pick-A-Shafts, can do the trick, Clarostat has them too.

Ask your Clarostat distributor for the *Clarostat TV Control Replacement Manual* (with supplements). Also for the latest *Clarostat Catalog No. 51*.

### Controls and Resistors

CLAROSTAT MFG. CO., INC., DOVER, NEW HAMPSHIRE  
In Canada: Canadian Marconi Co., Ltd., Toronto, Ontario



## PROFIT PICTURE WEAK?

# PICTURE TUBE REJUVENATOR

## BRIGHTENS PROFITS

**HOW IT WORKS:** Easy-to-install PICTURE TUBE REJUVENATOR increases cathode emission of weak CRT's by raising cathode temperature — brightens the TV picture.

**HOW IT SAVES:** Actually assures years of clear-vue TV pictures from weak tubes. Save the difference between a new C.R.T. and only \$2.79 for the REJUVENATOR! Save on SERVICE CONTRACTS and PARTS WARRANTIES. P.T.R. brightens your profit picture!

- ✓ Simple Plug-In Unit — installed in less than 1 minute.
- ✓ Permanent Hook-Up
- ✓ No Exposed Wires
- ✓ Fits all Size Tubes
- ✓ Automatically Operated

Model "C" for standard tubes **\$2.79 Dealer Net**  
Heavy duty Model "B" for electrostatic tubes as well as standard. **\$3.40 Dealer Net**

Available at Local Jobbers,  
or inquire

**LABORATORIES, INC.**

WHITEHALL BUILDING  
FAR ROCKAWAY, NEW YORK

# CREST

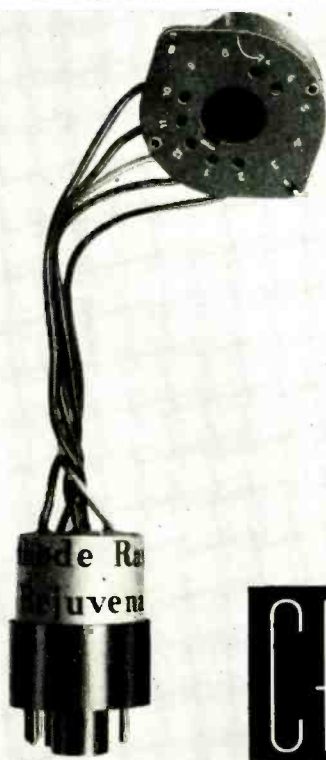

## BURKE'S STORY: "WHY THE SMALL SHOP WILL STICK"

Dear Editor:

Thanks for your letter of July 29th. I regret to say, however, that is one article that I cannot go along with. Although I agree whole-heartedly that the small shop can and will survive and that the big shop is in for some very serious troubles, I am afraid that Mr. Burke's thinking on the small shop is of the type that has so long kept the radio-television industry on a slave status.

I believe that the biggest contribution big TV shops have made to our industry has been the elimination of daytime, nighttime, Christmas, Yom Kippur, any-old-time service philosophy. Anyone who permits a business to make a slave of him is a damn fool. All of this talk about people being entitled to service after hours is not in keeping with 1952 thinking. My own company has, since the war, closed shop at 5:00 each day and 12:30 on Saturdays. We have made studies to find whether this was hurting our business and we are happy to say that it has actually helped us since it separated us from the "punks" who are so inferior that the only time they can get business is after hours. This experience has been repeated by thousands of other companies both large and small across the entire country.

Even the medical profession and pharmacists no longer operate on the outdated idea that they must be chained to their shops and offices. No longer do doctors break their necks to dash out to make calls unless they are absolutely certain that it is a matter of life or death. If human life can await the convenience of the doctor, why not a TV set?

We challenge Burke to prove that he ever actually makes any money on the service of a TV set in a tavern which is loaded with bar-fly experts during evening hours.

When Burke speaks of getting the tremendous rate of \$4.00 per call Sundays and overtime, he seems to think he is receiving top pay for qualified work. Apparently he has not had a haircut recently. Barbers in Chicago are now receiving \$1.50 for a haircut which takes 15 minutes time, or on the basis of \$6.00 per hour. Burke can drive a



"This schematic calls for 1/2 6N7 tube."





**FREE** Pocket adding machine with operating instructions in English and Spanish given free with every order of \$5.00 or more. **FREE** OFFER EXPIRES OCTOBER 31ST

**AMAZING TUBE OFFER**

All tubes are new & guaranteed for 90 days. Your money refunded if dissatisfied.

1A7GT	\$.99	6AU6	\$.39	12BA6	\$.60
1B3GT	\$.89	6AV6	\$.69	12BE6	\$.60
1N5GT	\$.79	6BC6	\$.69	12SK7GT	\$.72
1N5GT	\$.79	6BC6	\$.39	12SK7GT	\$.72
1R5	\$.69	6BE6	\$.69	12SQ7GT	\$.65
1S5	\$.67	6BG6	1.65	25L6GT	\$.75
1T4	\$.69	6BO6	\$.90	25Z5	\$.75
1X2	\$.89	6J5	\$.65	35W4	\$.52
3Q4	\$.85	6K6GT	\$.49	35Z5	\$.55
3Q5GT	\$.65	6SH7	\$.75	50B5	\$.65
5R4GY	1.49	6SJ7	\$.75	50L6GT	\$.65
5U4	\$.59	6SK7	\$.75	OA2	1.25
5V4	\$.69	6SN7	\$.59	OB2	1.25
5Y3GT	\$.45	6J6	\$.80	VR75	1.42
5Z3	\$.75	6T8	\$.75	VR90	1.23
5Z4	\$.85	6V6GT	\$.65	VR105	1.42
6AC7	\$.90	6W4	\$.49	VR150	\$.99
6AG5	\$.79	6X4	\$.70	1N21B	2.00
6AR6	\$.98	12AT6	\$.59	1N23B	2.75
6AK5	\$.82	12AT7	\$.80	2E25	3.80
6AL5	\$.29	12AU6	\$.67	304TL	6.95
6AQ5	\$.67	12AU7	\$.79	807	1.25
6AT6	\$.69	807	\$.89	866AX	2.15

Seven pin miniature tube socket given free with all tube orders.

**115V POWER TRANSFORMERS 60 CY**

58 V Half Wave	3A	2.95
68 to 83 V Half Wave	1.5A	1.25
300 V Half Wave	0.2A	.99
435 VCT 145 MA	6.3V 3A, 5V 3A	2.95
660 VCT 95 MA	6.3V 3A, 5V 3A	2.95
740 VCT 185 MA	6.3V 4A, 5V 3A	5.95
800 VCT 200 MA	6.3V 3A, 5V 3A	5.95
740 VCT 305 MA		4.95
750-000-0-600-750	VDC 225 MA	10.50
3600 VCT 350 MA		29.50
5400, 5500, 6200	VCT 110 MA	29.50

**CHOKES**

0 HY 50 MA	\$.39
9 HY 95 MA	1.15
7 HY 125 MA	1.49
8 HY 150 MA	1.95
6 HY 185 MA	2.35
10 HY 200 MA	2.75
4-16 HY 300 MA (Swinging)	4.99
5 HY 300 MA 70 ohms	2.99
8 HY 400 MA 110 ohms	5.59
8 HY 450 MA 80 ohms	6.50
6 HY 500 MA 35 ohms	7.25

**115V FILAMENT TRANSFORMERS 60 CY**

2.5 VCT 10A, 10 KV Insulation, Cased	\$4.50
5.0 VCT 3A, 2.5 KV Insulation	2.25
5.0 V 6A, 6.3 V 6A	3.95
5.0 V 12A, 2.5 KV Insulation	5.95
5.0 VCT 20A, 2.5 KV Insulation	6.85
5.0 VCT 30 A, 2.5 KV Insulation	7.50
6.3 VCT 1A	1.15
6.3 VCT 3A, 2.5 KV Insulation	2.25
6.3V X 6.3V en. 4A	2.95
6.3 VCT 8A, 2.5 KV Insulation	3.15
10 VCT 10A, 2.5 KV Insulation	6.00
24 V 1A, 2KV Insulation	3.49

We are open to buy meters, transformers, chokes, test equipment, tubes of all types or what have you.

**SIGMA SENSITIVE 5 Prong Plug in relay, polarized coil 3000 ohms D.C. operates on 2-4MA SPDT contacts. Ideal for use with electric eye, control of model hobby equipment etc. May be used directly in plate circuit of amplifiers etc. Removable dust cover permits finer adjustment of contacts.** **\$12.50**

**ZA GLIDE PATH RECEIVER, NEW, BLACK CRACKLE ALUMINUM CASE 6"X7"X12" complete with shock mount, (3) 6UB tubes, resistors, capacitors etc. Ideal for building test equipment, mobile x-mitters etc.** **\$3.95**

**TELECHRON 3.6 RPM SYNCHRONOUS 60 CY. CLOCK MOTOR, with micro switch & 30 minute timer gears. Motor may be used for electric clock or clock-radio replacement.** **\$2.95**

**ZA CROSS POINT LANDING INDICATOR (each 23316), contains 2 (0-200uA) meter movements, new.** **\$2.95**

**ZA BAND PASS FILTERS 60, 90 or 150 CY. each** **\$1.25**

**MOBILE VHF ANTENNA, MFG. BY G.E. 152-142 M, complete with 12 ft. RG58U Coax cable, removable antenna rod, mount, 831SP (PL-259) coax connector, installation hardware and instructions** **\$10.00**

**5HY 300 MA CHOKE, 70 OHMS, 2KV Insulation new \$2.99, 10** **\$25.00**

**115V POWER SUPPLY KITS 60 CY**

**A 660 VCT 95 Ma, 6.3V 3A, 5V 2A; 8 HY 100 MA CHOKES (2 ea.); 888 MFD 600 VDC OIL CAPACITORS** **\$6.50**

**B 740VCT 150 MA, 6.3V 4A, 5V 3A TRANSFORMER; 8HY 150 MA CHOKES; 888 MFD 600 VDC OIL CAPACITOR** **\$9.95**

**C PLATE TRANSFORMER 740VCT 305 MA; 5V 6A X 6.3V 6A DUAL FIL. TRANSFORMER; 4-6 HY 310 MA CHOKES (2 ea.); 888 MFD 600 VDC OIL CAPACITORS** **\$12.50**

**D PLATE TRANS. 750-600-0-600-750 VDC 225 MA; 6 HY 250 MA CHOKE (2); 6.3V 4A 6.3V 4A DUAL FIL. TRANSFORMER; 5V 3A FILAMENT TRANSFORMER; 2 MF 1.5 KVDC & 4 MF 1 KVDC OIL CAP.** **\$22.50**

Send for Bulletin  
**POLY TECH**

Dept. 10, 919 Dawson St., New York 59, N. Y.  
Murray Hill 6-2650

truck without any TV headaches on Sunday for about \$5.00 per hour. The \$4.00 Burke charges is certainly peanuts if he is really qualified and equipped to do a job.

One reason that intelligent contractors have eliminated overtime calls was not (as Burke intimates) that they were trying to rob the people of something, but simply the fact that they know the cost of service at overtime pay and they knew that the public was not prepared to pay honest rates. You see, legitimate contractors do not expect their employees to work for Chinamen's wages such as Burke is willing to accept.

Although I personally operate a medium-size shop, and I am very favorably disposed towards small shops, I am afraid that unless thinking such as Burke's is eradicated, the TV-radio service industry will again become a refuge for small men with small minds, small abilities, and small opportunities.

FRANK J. MOCH,  
Chicago, Ill. President, NATESA

**COST OF SCHOOLING**

Dear Editor:

In your July 1952 issue you published an article entitled "Selecting the Right Radio School." The information presented was certainly important because of the need for answers to numerous questions regarding an education in electronics. However, some of the data seemed to leave an absurdly false impression of those institutions in this country which offer liberal educations with standard degrees.

The author was right in many instances, but under the section "What type of school?", he stated as fact that a four-year education leading to an engineering degree costs from \$7,000 to \$10,000.

There are many schools where a four-year degree can be earned while living very comfortably for much less than \$7,000. Some of the most expensive schools in the midwest cost (everything included) less than \$1,200 per year, and most state colleges can be attended for considerably less than \$1,000 per year.

The school I represent offers only a two year pre-engineering course. But, as a private college supported by tuition fees and donations only, our estimate of living expenses and tuition ranges from \$725 to a maximum of \$957 per year. This is average for this part of the country.

WILLIAM J. RICHARDS  
Buena Vista College  
Storm Lake, Iowa

(A number of graduates of Eastern schools doubted very much that a student could live on the above sums. Living costs differ widely throughout this country, and it is likely that Mr. Richards is speaking for the lowest-cost area, as Mr. Rietzke is for the high-cost East.—Editor.)

a "TESCO" exclusive

the **ROCKE TENNA**

by T-V PRODUCTS CO.



Model PR 201 (Also Available Stacked - Model PR 402)

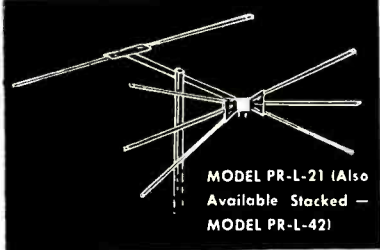

Model PR-L-21 (Also Available Stacked - Model PR-L-42)

- Amazingly Powerful Reception
- Rugged All-Aluminum Construction
- Lifetime Factory Warranty

Complete factory Preassembly features sensational "Quick-as-a-Wink" construction. No Nuts or Bolts to Tighten... rugged rivet assembly prevents damage by wind and storm vibration.

ANOTHER "TESCO" PRODUCT

**T-V PRODUCTS CO.**

152 SANDFORD ST. • B'KLYN, N. Y.

Write for Catalog RE





**A SWITCHING PROBLEM**

Dear Editor:

Perhaps some of your readers have come across this problem, and can help me find a solution.

The better FM and AM/FM tuners—such as the Browning and Radio Craftsmen—and many of the new audio preamplifiers are equipped with multiple inputs and a selector switch for feeding the audio system from various sources—TV, phonograph, or tape recorder. This is fine for transferring the signal inputs, but it means keeping all the equipment turned on all the time, or going through a complicated procedure of turning on (or off) the various pieces of equipment. This can be very inconvenient, especially where the units are in different parts of the room (as they are in the average home).

I know elaborate relay systems can be hooked up to control the various units automatically, but someone may have found a simpler solution.

STEFAN WAELDER

New York, N. Y.

September issue were supplied through the courtesy of the United States Army Signal Corps, Fort Monmouth, N. J. The credit line which usually appears in such cases was inadvertently omitted.

The omission is more regrettable in view of the fact that special effort was expended to obtain the photos, which were from a Signal Corps manual, and we again wish to thank the Signal Corps for their cooperation.

In the item "Measuring Inductance" on page 75 of the August issue, the formula which appeared as:

$$X_L \text{ (in henries)} = \frac{R^2 - R_L^2}{377}$$

should read:

$$L \text{ (in henries)} = \frac{\sqrt{R^2 - R_L^2}}{377}$$

R in this case referred to the resistance of the adjustable resistor in the circuit, which was set to equal the impedance of the coil, and  $R_L$  to the ohmic resistance of the coil.

The captions of the Brush Soundmirror and the Webcor Electronic Memory on page 52 were transposed. The Webcor instrument is at the right, and the

Soundmirror in the center (the name appears faintly in the photograph.)

It has been called to our attention that the choice of a horizontal output transformer photo to illustrate the article "Flyback Squeal," in the July issue, was singularly inappropriate. The transformer is the new RCA 230T1, a job designed to (among other things) reduce or eliminate this type of squeal. It is cushion-mounted, so that any attempt to pour cement between the core and frame would be the opposite of helpful. Tightening bolts is another technique that would not apply, since there are no through-bolts to tighten on the RCA 230T1.

We are happy to hear that the designers of this transformer are attacking the squeal problem right in the design, and we regret that it—rather than some older and more appropriate type—was used in such close juxtaposition to a drawing showing trouble points in a flyback transformer.

Two values were given for C8 in the parts list for the diathermy machine described on pages 58-60 of the September issue. The correct value is .0001  $\mu$ f (100  $\mu$ mf).

**CORRECTIONS**

The photographic illustrations for the article "Mobile Interference" in the

article "Mobile Interference" in the

**TeleSound CUSTOM-BUILT TV CABINETS**

**DIRECT FROM MANUFACTURER TO YOU—COMPARE PRICE and QUALITY!**

Be price conscious! TELESOUND Wholesale Prices enable you to sell more, make a BETTER PROFIT for yourself!



H:25", D:21 1/2", W:25" Wgt: 50 Lbs.  
TABLE MODEL 500 ..... **\$42.00**



H:40 1/4", D:22 1/2", W:25 1/4"  
Wgt: 60 lbs.  
CONSOLE MODEL 200 ..... **\$45.50**



H:40 1/2", D:24", W:25"  
Wgt: 100 lbs.  
CONSOLE MODEL 800 ..... **\$82.50**

**ALL PRICES TAX INCLUDED**

**TV PICTURE TUBES**

**SHELDON BLUE LABEL**  
One Year Guarantee  
Dumont—1 Year Guarantee  
**DON'T BE MISLED—**  
Demand Guaranteed STANDARD BRANDS!

- 12 1/2" Black or White ..... \$20.50
- 14" Glass Rect. (Blk) ..... \$20.50
- 16" Glass Round (Blk) ..... \$30.50
- 16" Glass Rect. (Blk) ..... \$30.50
- 17" Rectangular (Blk) ..... \$29.50
- 19" Round (Blk) ..... \$33.50
- 20" Rectangular (Blk) ..... \$35.50
- 21" Rectangular (Blk) ..... \$39.50
- 24" Metal ..... \$69.50
- 27" Rectangular ..... Wholesale Price on Request

**Famous SUPER DeLUXE 630 CHASSIS**

—YOUR CHOICE—  
**REGAL**  
or  
**VIDEO** Model 630K3C



**SMASHINGLY LOW PRICED!**

**\$139.50**

- 30 tubes—for 16" to 24" Picture Tubes
  - High Efficiency High Voltage Circuit
  - Keyed AGC
  - Automatic brightness control
  - Special extra high gain Cascode Stand-ard Coil Tuner
  - Directly adaptable for UHF.
  - 12" Quality Speaker
  - Factory wired, aligned, tested.
  - Complete, ready to play, including tubes, knobs and hardware
  - Less CRT
- DeLuxe Techmaster 2431P Chassis. Complete less CRT ..... \$189.50**  
**FREE OFFER!** Schematic Diagram and complete 24 page service manual **FREE** with any of these chassis!

**Here's the "PACKAGE DEAL" You've Waited for!**

SAVE MONEY! Order the cabinet of your choice from the TeleSound models illustrated, in combination with the famous 630 TV Chassis, (Regal or Video), 12" speaker, and your choice of picture tube. If Techmaster C-30 chassis desired, add \$10.00 to combination price. For Video 630DX DeLuxe chassis add \$10. Check these sensationally low prices:

CABINET STYLE	17" CRT	20" CRT	21" CRT	24" CRT
500	\$205.75	\$211.60	\$215.50	\$258.20
200	209.15	215.00	218.90	.....
800	245.10	251.05	254.95	.....
1200*	291.50	297.35	301.25	.....

\*Record Changer not included.

**TERRIFIC TELESOUND OFFER**

Any above combination, consisting of your choice of TV chassis, 12" PM Speaker and Picture Tube, **FACTORY-INSTALLED** in the cabinet of your choice, tested, and ready to play ..... for only **\$15.00** Additional

Please include 25% deposit with orders, balance C.O.D. All shipments F.O.B., NYC "Designers & Manufacturers of Custom TV and Radio Furniture"



421 West 28th Street  
New York 1, N.Y.  
Phone: WI 7-0719

**IT SELLS BEST because  
IT PERFORMS BEST**

**DAVIS SUPER-VISION  
ALL-CHANNEL ANTENNA**

FOR FRINGE AREA or DX  
With ELECTRONIC DIPOLE SEPARATORS  
"THE ORIGINAL ANTENNA SOLD WITH  
A MONEY-BACK GUARANTEE"

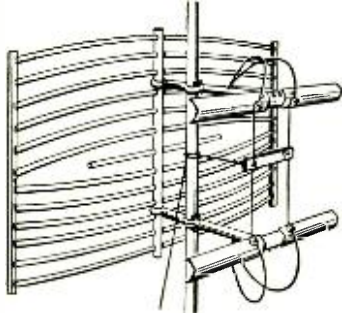

1. EXCELLENT FOR FRINGE AREA and DX RECEIVING—and broad band receiving with high gain on all channels—2 through 13.
2. CLEARER PICTURES UP TO 125 MILES OR MORE—from the station.
3. GHOST PROBLEMS REDUCED or eliminated due to excellent pattern.
4. PROVIDES 10 DB OR MORE GAIN ON HIGH CHANNELS where gain is needed most.
5. EXCELLENT FRONT TO BACK RATIO on all channels. No co-channel interference.
6. MINIMIZES INTERFERENCE: Airplane Flutter—Diathermy and Ignition—F.M.—Neon Signs—X-Ray—Industrial—Etc
7. ELIMINATES DOUBLE STACKED ARRAYS, and out-performs 2 bay yagis on low band and 4 bay yagis on high channels.
8. ONLY ONE TRANSMISSION LINE NECESSARY.
9. NO WORRY OVER POSSIBLE CHANNEL CHANGES on either high or low channels.
10. CAN BE TIPPED WITHOUT TILTING MAST to take advantage of horizontal wave lengths.
11. Can be used with ANTENNA ROTOR AT YOUR JOBBERS, OR WRITE TO:

DAVIS ELECTRONICS 1-18  
4313 West Magnolia Blvd., Burbank, California  
SIRS: RUSH INFORMATION TO ME AS CHECKED BELOW:

- Send Free Technical Data on new SUPER-VISION ANTENNA.  
 Send Name and Address of NEAREST JOBBER.

Name \_\_\_\_\_  
Street \_\_\_\_\_  
City \_\_\_\_\_ State \_\_\_\_\_

**ARE YOU MOVING?**

—Don't forget to send us the address label from your last copy of Radio-Electronics . . . plus your new address.

—If we receive these before the 10th of the month, you will continue getting the magazine without interruption.

Any or all of these catalogs, bulletins, or periodicals are available to you on request direct to the manufacturers, whose addresses are listed at the end of each item. Use your letterhead—do not use postcards. To facilitate identification, mention the issue and page of RADIO-ELECTRONICS on which the item appears. All literature offers void after six months.

**SYLVANIA BULLETIN**

Sylvania Electric Products, Inc., has released a new bulletin describing the production facilities available at their Parts Division. The 20-page booklet tells of the company's manufacturing and engineering services in plastics, formed metal parts, wire, welds, mica, and electronic components. Automatic machinery for achieving close tolerances on all products is described and illustrated.

The bulletin is available from the Parts Division, Warren, Pa.

**THYRITE RESISTORS**

New miniature resistors whose electrical resistance decreases with increases in applied voltage are described in General Electric's bulletin GEA-4138C.

The resistors are composed of a silicon carbide ceramic resistance material called Thyrite, whose nonlinear resistance characteristic is stable and substantially independent of polarity and frequency.

Gratis from General Electric, Schenectady 5, N. Y.

**CAPACITORS**

Cornell-Dubilier's catalog TVR-7A is a 39-page guide arranged to enable the technician to locate the correct replacement capacitor. With the 9 types of twist-prong electrolytic capacitors added since last year, 134 new TV set models may be serviced.

Gratis to technicians through local Cornell-Dubilier distributors.

**MOBILE ANTENNAS**

Ward Products Corp. has released a catalog describing antennas and accessories for mobile use with descriptions and specifications for each model.

A second booklet, "How to Specify Mobile Antennas," describes the base, whip, and spring combination, stating the factors involved in buying them, and describing how these components are produced.

Gratis from Ward Products Corp., Division of the Gabriel Co. 1523 E. 45 St., Cleveland 3, Ohio.

**FACILITIES BROCHURE**

General Cement Mfg. Co. has issued a 16-page illustrated brochure, "The Story of G-C," to show the part played by the firm in supplying electronics components to the radio-television industry and other fields, and to acquaint customers with the size and extent of its manufacturing facilities.

Gratis from General Cement Mfg. Co., 919 Taylor Ave., Rockford, Ill.

*For better, quicker servicing*



USE  
**Mandl's**

**Television Servicing**

Here are detailed, illustrated instructions for locating and correcting EVERY flaw or failure that may occur in each stage of today's TV receivers. You'll learn simple signal tracing procedures; trade tricks in diagnosing troubles in minimum time; the essentials of successful VHF and UHF servicing; how to trouble-shoot A.G.C. circuits, synchroguide circuits, and all other circuits, including the latest improvements. A complete master trouble index enables you to QUICKLY find the cause of and procedures for correcting any trouble, including those hard-to-find troubles. Hundreds of diagrams, original photographs of flaws as they appear on the TV screen, oscilloscope patterns and other illustrations further aid you in locating trouble, testing, and making adjustments.



**Noll's  
Television  
for Radiomen**

Very clear, thorough, non-mathematical explanations of the function and operating principles of every element and circuit in TV reception; how the receiver is constructed; basic principles of transmission; and the techniques of installing, adjusting, and aligning today's receivers, with full instruction on test equipment and its use. Here, in the simplest, clearest terms, is the basic knowledge that is a MUST for good TV work.

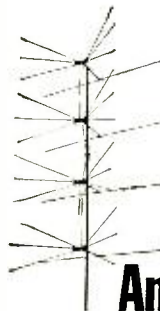

AND  
**Noll & Mandl's  
Television  
and FM  
Antenna Guide**

Are fringe area reception, ghost reception, interference your problems? This book shows you how to overcome them—how to improve gain; minimize noise on the transmission line; get the MOST out of the antenna system at any location. It tells how to determine the right type of antenna for the site and the best position for it; gives full data on all types of antennas including those for the new UHF and VHF locations, yagi antennas, stacking, boosters, and other fringe area aids.

**NOW MORE THAN EVER, YOU'LL NEED THESE EXPERT SERVICE AIDS.**

**SEE THEM ON APPROVAL**

The Macmillan Co., 60 Fifth Ave., N. Y. 11 E

Please send me the books checked below. I will either remit in full or return the books in 10 days.

- Mandl's TV Servicing \$5.50     TV & FM Antenna Guide \$6.25  
 TV for Radiomen \$7.75

Signed .....

Address .....

(This offer good only within continental limits of U.S.A.)



# ADSON features PRECISE Development Corp. Instrument Kits

Precise Instrument Kits give you everything—fully engineered circuits, finest component parts, easy-to-follow wiring diagrams. Anyone can assemble these precision test instruments that compare with the finest factory-made equipment. Save money, enjoy the thrill of making your own instruments. Order any advertised Precise kit from Adson, famous for lower prices!

- PRECISE
- RF-AF-TV
- Marker
- Generator
- Kit



First kit to reach 110 mc on fundamentals, 330 mc on harmonics. 7 bands on RF frequencies. 4 bands on AF frequencies. Audio, 20-20,000 cycles. Steel cabinet. Complete with tube complement. Model 630K . . . . . \$33.95

PRECISE Vacuum Tube Voltmeter Kit. Rugged over-size 4 1/2" meter. Wide ranges on AC, DC, Ohms, DB. Steel cabinet. Complete with tube complement, leads, and internal battery. Model 909K . . . \$25.98

PRECISE Universal AF Sine, Square, and Pulse Generator Kit. Model 635K . . . . . \$33.50

PRECISE DELUXE Vacuum Tube Voltmeter Kit. 7 1/2" meter. Model 907K . . . . . \$38.98

PRECISE R.F. Probe. Model 912 . . . . . \$4.25

PRECISE High Voltage Probe, Model 999 . . . \$6.98

Satisfaction guaranteed. Send check or money order. 25% deposit with C.O.D. All orders shipped within 24 hours, F.O.B. New York. Please include postage.

**ADSON RADIO & ELECTRONICS CO.**  
221 Fulton St., New York 7, N. Y.

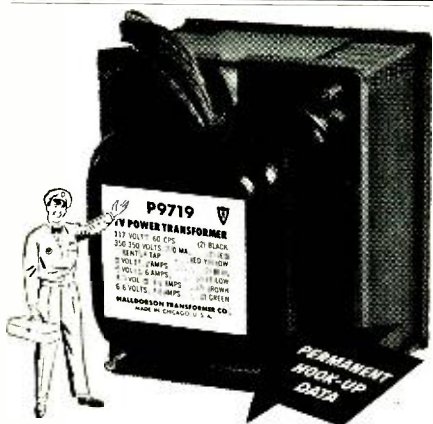

**Where You Need it!  
When You Need It!**

NOW—no more halted work, no more writing to the factory for missing instruction sheets. Tough identifying labels giving complete application and hook-up data are affixed to all Halldorson components. This provides maximum convenience in original installations or reuse at some later date. The same data appears on each box for instant identification.

This is only one of Halldorson's many aids designed to save your valuable time. Look to Halldorson for the biggest variety of transformer components, plus the newest for TV. Ask your distributor for your copy of Halldorson's great new catalog and TV Replacement Guide . . . today. The Halldorson Transformer Co., 4500 N. Ravenswood Ave., Chicago 40, Ill. Dept. RE.0



EXPORT: Intex Co., Inc., 303 W. 42nd St., New York 36, N.Y. Cable Address: Intexcom, N.Y.

## CONNECTOR BULLETIN

Cannon Electric has just issued a 32-page Audio-Type Connector Bulletin (No. PO-4-1952) adding new and improved connector types for microphone, public address, and low-level sound applications. This bulletin covers all pertinent engineering data on type series P, O, X, XK, X, BRS, BG, and UA.

These connectors meet RTMA Standards. The type BG series is designed for communications and is used largely by the Signal Corps.

This bulletin is available upon request to the Cannon Electric Advertising Department, P.O. Box 75, Lincoln Heights Station, Los Angeles 31, Calif.

## SPRAGUE CATALOG

Sprague's new catalog, C-608, superseding C-607, describes the company's capacitors, resistors, interference filters, and test equipment for television and radio.

Gratis from Sprague Products Co., North Adams, Mass.

## WALDOM CATALOGS

Two new catalogs released by Waldom Electronics, Inc., are the 1952 Waldom Replacement Speaker Cone Manual No. 52 and the Waldom Electronic Components and Cname Products Catalog No. 5C2.

The first lists over 5,000 models of 105 set and speaker manufacturers, showing model number, speaker size, and replacement cone number, with a section showing how to replace a speaker cone.

The second catalog has descriptive listings and illustrations of knobs, dial plates, title plates, Croflex tuners, auxiliary drives, instrument dials, auto radio controls panel kits, tube sockets, terminal strips, and TV components.

Both are available on request from Waldom Electronics, Inc., 911 No. Larabee St., Chicago 10, Ill.

## NEEDLE REPLACEMENT GUIDE

Catalog and Replacement Guide No. 102 is a 34-page, 8 1/2 x 11-inch booklet with six pages devoted to a descriptive listing of the Permo line of magnetic recording wire, tape, accessories, and phonograph needles. The balance of the booklet is a needle replacement guide listing the cartridge manufacturers' names and needle numbers, the Permo needle number, jobbers' parts numbers, tip material, prices. Needle and cartridge types are illustrated.

A copy can be obtained by sending a letterhead request to Permo, Inc., 6415 Ravenswood Ave., Chicago 26, Ill.

## ELECTRONIC COMPONENTS

Switchcraft, Inc., has issued a new 16-page catalog which includes many additions to the present line of components as well as new items of special interest such as adapters, shielded jacks, microphone connectors, lever switches, and cable assemblies.

Copies sent on request to Switchcraft, Inc., 1328 N. Halsted St., Chicago, Ill.

END

the only personal  
part of any  
communication  
system!

more  
**LISTENING  
COMFORT**  
with . . .

**TELEX  
lightweight  
headsets!**

**\*MONOSET**  
The modern styling and the dependability and superior performance of the TELEX Monoset have made old fashioned headphones obsolete. Magnetic.

**\*DYNASET**  
New dynamic under-chin TEL-EX Dynaset, with more highs and lows of both music and speech, is the delight of radio and TV monitors. Weighs only 1.25 oz.

**\*TWINSET**  
This lightweight 1.6 oz. TELEX Twinset pipes signal directly into the ear, blocking out ground noises and banishing listening fatigue. Magnetic.

**\*EARSET**  
Sensitive TELEX Earset slips onto ear and is preferred by all who use single-phone headsets. Weighs only 1/2 oz. and leaves other ear free for phone calls or conversation.

\*Trade Mark      Standard of  
the World for  
Quality  
Headsets

**TELEX**  
HEARING AT  
ITS BEST

For complete information on any of the above headsets, write

**TELEX ELECTRO-ACOUSTIC DIV., Department, 4-B St. Paul 1, Minnesota**

In Canada  
**ATLAS RADIO CORP., Toronto**

**\$3.00 FOR CARTOON IDEAS**

RADIO-ELECTRONICS prints several radio cartoons every month. Readers are invited to contribute humorous radio ideas which can be used in cartoon form. It is not necessary that you draw a sketch, unless you wish.

**Address**  
**RADIO-CARTOONS,  
RADIO-ELECTRONICS  
25 West Broadway,  
New York 7, N. Y.**

# Know More and EARN MORE

WITH These 4 Brand-New Reference Guides for Radio and TV Engineers. Written by Top Experts for the Men Who Want to "Go Places" in Electronics. Read The Descriptions Then Use the Coupon Below to Order Any or All for 10-Days' FREE EXAMINATION!

**ELECTRONICS FOR COMMUNICATION ENGINEERS**, Edited by John Markus and Vin Zeluff. Keeps you up-to-date on the latest developments in electronics; saves time on research problems. Includes 252 of the most important recent articles written on electronics. A gold-mine of design equations; charts; nomographs; tables; etc. Covers amplifiers, antennas, audio, cathode-ray tubes, receivers, transmitters, power supplies—and much more. 624 pages. Hundreds of helpful pictures, charts, etc.

Only \$10.00



**MUSICAL ENGINEERING**, by Harry F. Olson (Dir. RCA Acoustical Lab.). The theory and practice of musical engineering made EASY! Covers all phases—including speech, musical instruments, acoustics, hearing. Analyses sound reproduction and pickup systems. Treats construction, range, vibrating and resonating systems of instruments. Latest research on improved production; studio acoustical designs; recording; transmission; broadcasting. 309 pages, 303 "how-to" illus., 28 Tables. Only \$6.50

**TELEVISION ENGINEERING**, by Donald C. Fink (Editor, "Electronics"). Everything you'll ever want to know about TV—from studio-to-receiver—in ONE encyclopedic guide. Covers TV technology; operating principles; use of equipment. Provides practical working diagrams, inter-carrier sound receptions, distributed amplification—and much more. New, revised, enlarged 2nd edition. 721 Pages, 512 valuable diagrams, charts. Only \$8.50

**RADIO ANTENNA ENGINEERING**, by Edmund A. Laport (Chief Eng'r RCA Int'l Div.). Brand-new guide to the design and construction of receiving and transmitting antennas used in broadcasting; point to point, ground to air, and military communications. Covers radiating, circuit, and mechanical engineering. Gives operational requirements; bandwidth propagation and system engineering for each type of antenna. Includes advanced designs for very-high and ultra-high frequency techniques. 536 pages, 386 illustrations. Only \$9.00

**FREE 10-DAY TRIAL COUPON**

McGRAW-HILL BOOK CO., Dept. RE10-52  
330 W. 42nd St., New York 36, N. Y.

Send me the books checked below for 10-days' FREE EXAMINATION. If not convinced they will be valuable in my work, I may return books—and owe nothing. Otherwise, I will send a small down payment (plus postage charges then, and pay the balance on easy terms).

- Electronics for Communication Eng. .... \$10.00
  - Musical Engineering ..... \$ 6.50
  - TV Engineering ..... \$ 8.50
  - Radio Antenna Engineering ..... \$ 9.00 (Print)
- Name.....  
Address.....  
City..... Zone..... State.....  
Position..... Company.....

**SAVE POSTAGE CHARGES.** Check here if enclosing check or money order for total price of books so ordered. Then we pay all postage charges, same return-for-refund privilege. (Offer good in U.S. only.)

TV AND YOU, by John B. Ledbetter. Published by the John B. Ledbetter Co., P.O. Box 1122, Cincinnati, Ohio. 6 x 9 inches, 72 pages. Price \$1.00.

Aimed like many others at the TV owner, this book cannot be classed with any of them. Unlike the "Guide" type of work, it simply attempts to tell the owner how his set works, and why it gets out of adjustment. It does not attempt to explain electronic theory or TV transmission and reception. It does tell the owner what tubes are in his set, what effect the failure of each one of them might have, and shows numerous patterns to illustrate the point.

The set owner gets a much better break in the descriptions of adjustments than the reader of earlier works. Ledbetter is thoroughly familiar with his subject, and tells his readers what they may expect to find and where to look for it; for example, how various manufacturers differ in their methods of making the tuning adjustments accessible, what may happen when certain controls are turned too far in each direction, and how to select the midpoint between them for "best picture."

Apparently television (like the motor car) will ultimately produce a group of owners who—through costly experience or other means—are going to learn to make minor repairs and adjustments, calling the technician only when his skills are needed. This is an excellent textbook for that group.

It is more than possible that such owners will give the technician less business than others. There is certainly no doubt that the relationship between them and their repairmen will be much better than average, since—like the semi-skilled car owner—they will realize the complexities of their equipment, and know by experience that time and trouble are involved in its repair.

The author lays an excellent foundation for such good understanding in one of his opening paragraphs "Why Your Serviceman Must Charge" and on his last page under the headings "About Fix-It-Yourself Books" and "What Your Serviceman Is Doing to Help You." The latter item, incidentally, names and recommends the chief radio and TV technicians' associations.—FS



Beautiful TV CABINETS For Custom-Built Sets or Conversions

Series 503 TV Cabinets accommodate all 630. Radio Craftsmen & similar Chassis, all round & rectangular tubes. Complete with all mountings for tube & yoke. Fidelity-styled in Period, Traditional & Modern; hand-rubbed to high lustre in Mahogany, Walnut, Ebony or Blonde. 40" h. 24" w. 24" d.

Series 505 TV Combination Cabinets have identical features plus separate compartments for all FM-AM radio chassis, record changers & record storage. 40" h. 40" w. 24" d.

Series RP3 RADIO-PHONO COMBINATION CABINETS

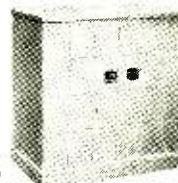

Compartments for record changer, radio chassis, record storage and 15" or 12" speaker. Fidelity-styled in Period, Traditional & Modern; hand-rubbed to high lustre in Mahogany, Walnut, Ebony or Blonde. 36" h. 34" w. 19" d.

Write NOW for literature and prices.

STANDARD WOOD PRODUCTS CORP.  
43-02 38th St. Long Island City 1, N. Y.

proved SUPERIOR!

Rohn TV TOWER

**Better reception**—with Rohn, you have proper antenna height, especially for UHF reception, it is necessary to have antenna elevation to get away from signal interferences. Rohn Towers can give this height best—and most economically.

**Long-Life**—Sturdy, durable—Made of tubular steel, electric welded—in 10 ft. sections. Permanent, rust-resistant finish. Can be climbed for service work.

**Beauty**—Neat and trim—no guy wires needed up to 50 ft. Easily and quickly installed in small concrete base.—Takes less than 2 hours to erect.

Get full details on Rohn Towers—that have every feature proved to be of value! Sell with confidence—sell Rohn!

JOBBER INQUIRIES  
INVITED WRITE,  
WIRE or PHONE  
Collect TODAY

Manufactured exclusively by

Rohn

MANUFACTURING COMPANY

2108 MAIN ST.

PEORIA, ILL.

Manufacturers of Antenna Towers for TV, Police and Industrial Services

RADIO-ELECTRONICS



**LEARN TELEVISION**  
**ELECTRONICS and RADIO**  
 Engineering Laboratory and Classroom  
 Training. Day and Evening Classes  
 Write for illustrated Catalog  
**ELECTRONICS INSTITUTE, Inc.**  
 21 HENRY, DETROIT 1, MICH.

**FOR THE FIRST TIME!**

For several years you've read about the Don Martin School now—for the first time—we are prepared to offer a course by mail. You can obtain your first class radio telephone operator's license from this special course. Operators are desperately needed now by radio and TV stations as well as the aircraft industry. Secure your future.

Be certain that your training is of the best, enjoy the school recognized by the profession. Write today for full information.

**THE DON MARTIN SCHOOL OF RADIO AND TELEVISION ARTS AND SCIENCES**  
 Correspondence Section  
 1655 No. Cherokee, Hollywood 28, Calif. HU. 2-3281.

**CUSTOM - BUILT RADIO-PHONOGRAPH INSTALLATIONS "SOUNDCRAFTERS" F.M.-A.M. 13 Tube Chassis**

**HIGH FIDELITY**  
 Complete, ready to plug in—including amplifier with all tubes and 16" or 12" P.M. Speaker



**\$67.50**  
 List \$139.50

FM tuning range 88 Megacycles-108 Megacycles. AM tuning range 535 Kilocycles-1650 Kilocycles. Individual circuit de-coupling insures minimum circuit drift. Dial, large, easy-to-read multicolor slide rule type. Tone range covers all tones from 30 cycles to 15000 cycles. Brand new, original factory sealed carton. Built-in pre-amp for reluctance pickup and XTAL input. Push-Pull audio output 14 watts. Volume tone and bass controls. Antenna, foiled FM aerial, knobs, plugs, etc. Instructions incl. 12 3/4" x 10 1/2" x 7 3/4" hkh. Will accommodate 2 speakers. **RCA LICENSED**

**WEBSTER #100 Changer w/GE Cart. . . . . \$30.95**  
**VM No. 950 WITH GE CARTRIDGE. . . . . 28.95**

Console Cabinet available to fit Chassis and Record Changer  
**Immediate Delivery—Fully Guaranteed**  
 Come in or order by mail—\$10 on C.O.D. orders  
**JAN ELECTRONIC DIST. CO.**  
 222 FULTON ST., N. Y. 7, N. Y. DEPT. RE WO 4-0632

**NEW "HOTIP" MAKES SOLDERING EASIER, FASTER, NEATER**

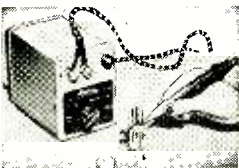

New Hotip makes soldering easy as pie. Perfect for miniatures, difficult assemblies, close circuits. Soldering tweezers with insulated handle, control box with selection of 5 temperature ranges, and line cord included.

Your Cost **\$29.70**

Will solder finest wires like No. 32AWG to two No. 11. Your choice of foot or knee switch.  
 10% cash with order

**ALMO RADIO CO.**  
 509 ARCH ST. & 6205 MARKET ST.  
 Philadelphia, Pa.  
 6th & ORANGE STS. • Wilmington, Del.  
 4401 VENTNOR AVE. • Atlantic City, N. J.  
 1133 HADDON AVE. • Camden, N. J.  
 219 Highland Ave. • Salisbury, Md.

**BE A RADIO ENGINEER!**  
 You can enter this uncrowded, interesting field. Defense expansion, new developments in electronics demand trained technicians. Study all phases radio & electronics theory and practice: TV; FM; broadcasting; servicing; aviation; marine; police; radio. 18-month course equal in radio content to 4 yrs. college U.S. or equivalent required. Begin Jan. March, June, Sept. Campus life. *Catalog.*  
**VALPARAISO TECHNICAL INSTITUTE**  
 Dept. C Valparaiso, Ind.

**TELEVISION-RADIO ELECTRONICS**  
 Training in all branches television, radio and electronics. FCC exam. preparation. Write for free catalog.  
**COMMERCIAL RADIO INSTITUTE**  
 (Founded 1920)  
 38 W. Biddle St., Baltimore 1, Md.  
 Approved by Maryland State Board of Education

**Unlimited Opportunities in RADIO ENGINEERING DEGREE IN 27 MONTHS**  
 Complete Radio Engineering course including Telev., U. H. F. and F. M. Bachelor of Science Degree also in Mech., Civil, Elect., Chem., and Aero. Eng.; Bus. Adm., Acct. Extensive campus, modern buildings, well equipped labs. Low cost. Prep courses. Personalized, practical instruction. Founded 1884. Placement service. Growing shortage of engineers. Prepare now for unlimited opportunities ahead. Enter September, January, March, June. Write for catalog  
**TRI-STATE COLLEGE**  
 24102 College Ave. ANGOLA, IND.

**TV SERVICING E-X-C-L-U-S-I-V-E-L-Y**  
 DO YOU want to get into TV servicing . . . operate your own TV shop . . . get into the \$5,000 a year income bracket? If you are serious-minded, you CAN increase your earning power within a few months.  
 To do this, you need the BEST—the most COMPLETE TV servicing & maintenance training available. TV Servicing is a highly-skilled type of work that requires PRACTICAL, SPECIALIZED training. Engineering theory, design factors & mathematics are not essential to TV Servicing.  
 LEARN the operation of every TV component; how to use TV test equipment; how to diagnose TV troubles & locate defective parts; HOW TO SERVICE ALL TYPES OF TELEVISION RECEIVERS in our fully-equipped shops.  
 WesternTV students actually work on more than 20 different types of popular, name-brand TV sets. They learn to use more than 15 different types of test & measuring instruments & equipment. THIS is the kind of training that CAN prepare you for a SUCCESSFUL career in TV SERVICING.  
 Without obligation, write for our new booklet E-10. It's illustrated to show you the best-equipped trade school TV shop & laboratory on the West Coast.  
**APPROVED FOR VETERANS**  
**WESTERN TELEVISION INSTITUTE**  
 341 West 18th St., Los Angeles 15, Calif.

**RADIO ENGINEERING DEGREE IN 27 MONTHS**  
 Intensive, specialized course including strong basis in mathematics and electrical engineering, advanced radio theory and design, television. Modern lab. Low tuition. Self-help opportunities. Also B.S. degree in 27 months in Aeronautical, Chemical, Civil, Electrical, and Mechanical Engineering. U.S. Gov't approved. Enter December, March, June, September. Catalog.  
**INDIANA TECHNICAL COLLEGE**  
 1510 E. Washington Blvd., Fort Wayne 2, Indiana

**RADIO and TELEVISION ELECTRONICS**  
 in all Technical Phases  
 New Classes (Day & Evening)  
 Start 1st of Dec., Mar., June, Sept.  
**FREE PLACEMENT SERVICE**  
 for GRADUATES  
 For Free Catalog write Dept. RC-52  
**RCA INSTITUTES, INC.**  
 A Service of Radio Corporation of America  
 350 West 4th St., New York 14, N. Y.

**Become an ELECTRICAL ENGINEER in 36 MONTHS**  
 Bachelor of Science Degree — Major in Electronics or Power

It is estimated by 1955 there will be at least two positions for every engineering and technician graduate. This college offers a tested plan that permits you to enter these vast employment opportunities at an early date. Save a valuable year through optional year-round study. Receive advanced credit for prior training gained in the armed forces, other schools or field experience.

**ENTER BOTH RADIO AND TELEVISION** 12 months or one-third of the B. S. degree course (Electronics major)—also brings you the *Radio Technician's* certificate. An added 6-month course qualifies you for the *Radio-TV Technician's* certificate. Recent developments open unlimited opportunities for TV technicians and engineers.

**THE PROVEN "UNIT CHASSIS SYSTEM"** of teaching was developed here. It "breaks down" the TV set by stages. You learn every component of all types and makes — and are prepared for future design changes, including the advent of color.

**12-MONTH TELEVISION SERVICE COURSE . . .** trains for good servicing jobs and shop ownership in the shortest practical time under expert instructors.

**Terms open January, April, July, October.** Over 48,000 former students from all states and 23 overseas countries. Faculty of trained specialists. Modern laboratories and equipment.

Write for free 110-page catalog, 48-page pictorial booklet "Your Career" and "Occupational Guidance Bulletins."

**MILWAUKEE SCHOOL OF ENGINEERING**  
 NONPROFIT • FOUNDED IN 1903



Milwaukee School of Engineering  
 Dept. RE-1052, 1025 North Milwaukee  
 Milwaukee 1, Wisconsin

Without obligation send **Catalog** for Electrical Engineering, B. S. Degree, major in  Electronics;  Power;  "Your Career";  Occupational Guidance Bulletin on:  Radio-TV;  Electrical Power;  Welding;  Heating, Refrigeration, Air Conditioning;  Mechanical Engineering, B. S. Degree;  Preparatory;  Television Service.

Name.....Age.....  
 Address.....  
 City.....Zone.....State.....  
 If veteran, indicate date of discharge.....



# TAB That's A Buy!

### PHOTOFLASH PWR SUPPLY KIT

1800 V at 35 MA, using doubler circuit. Transformer, rectifiers, sockets, resistors, condensers & diagram. Complete with sunflash tube V-4X4/X400 Rated 200 watt sec. Operates from 115V/60 cy. . . . . \$31.98

### PHOTOFLASH CAPACITORS

2x.36 MFD. 100 W.D. per unit. 30 units 21.6 MFD. 1800 VDC/38.8 Watt sec. . . . . \$5.95  
30 units 21.6MFD/3000VDC/64.8 watt sec. . . . . 7.95

### TAB "SUN-FLASH" LAMPS

"Tab" No.	Replaces	Max. W-sec.	Each
U10	AMGLO 5804X	100	\$ 8.49
No. 1	GE FT 210	200	9.98
23ST	GE FT 403	500	15.98
33GT	SV4T 4330	240	9.98
VA	PT 214	250	10.98
23MT	ET 110	200	10.94
22ST	55R3	500	4.98
33GTQ			

Write for Complete "THRIFTLITE" Data Booster-packs, Ext. Lites, Units for Focal plane shutters & accessories.

### INFRARED SNOOPSCOPE

Image Converter Tube HiSensitivity simplified design 2" dia. Willemite screen (Resolution up to 350 lines/in. Complete data & tube, each. . . . . \$4.98; 2 for \$9.49

### SNOOPSCOPE PWR SUPPLY KIT

Inpt 115V/60cy outpt 1800V DC/35ma, using voltage doubler circuit. Incl. trans, rectifiers, sockets, resistors, condens, and wiring diagram. . . . . \$6.98

### SELENIUM POWER SUPPLY

0 to 12VDC/2.5Amps Variable DC supply. Unceased and completely built-inpt. 115V/60 cy. Usable LAB supply, filament D.C., plating, battery charging, model railroad, includes voltage or speed control and center off reversing sw. Ideal for two "HO" locomotives. "TAB" Special \$10.95 2 for . . . . . \$20.00

### FULL WAVE BRIDGE SELENIUM RECTIFIERS

Current (Cont)	18/14 volts	26/18 volts	36/28 volts	130/100 volts
2 amps	2.20		3.60	2.5A \$13
4 amps	3.75		6.75	
5 amps	4.95		7.95	27.00
10 amps	6.75	9.98	12.00	45.00
12 amps	8.50		16.00	52.50
24 amps	13.25	16.20	24.00	90.00
24 amps	16.00		31.00	98.00
30 amps	18.50	24.30	36.00	
36 amps			45.00	

CT Rectifiers 100 amp 10-0-10V . . . . . \$4.95  
Full Wave Selen Rect & Trans. with Ageing Taps, 100 ft. form. All 115V/60cy inputs.  
up to 18 VDC at 12 amps. . . . . \$23.98  
up to 28VDC at 12 amps. . . . . 29.98  
up to 28VDC at 48 amps. . . . . 149.50  
up to 420VDC at 6 amps. . . . . 12.98  
1000 ft. amp supply has no ageing taps. . . . . 90.00

### RECTIFIER TRANSFORMERS

18-0-18-20-20-4-21.4 volts/12 amp 2Kvlns. . . . . \$14.98  
11-32-34-36 volts/12 amp 2Kvlns. . . . . 16.49  
18-12-0-CT-9-12-18 volts/4 amp. . . . . 8.95  
18-12-0-CT-9-12-18 volts/12 amp. . . . . 16.75  
100VCT-24V-18V/24 amp. . . . . 35.75

### ONE YEAR GTD TV PICTURE TUBES

10 inch Round	\$14.95
12 inch Round	19.95
14 inch Rectangular	20.95
18 inch Round	22.95
16 inch Rectangular	24.95
17 inch Rectangular	24.85
19 inch Round	28.50
20 inch Rectangular	30.45
21 inch Rectangular	30.45
24 inch Metal	67.00

Your old pict tube is worth money. Write for trade-in allowance toward RMA coded and dated tubes with one year guarantee. Ship your defective picture tubes prepaid only. When ordering metal tube, defective metal tube is required.

### "TABS" TUBE SPECIALS

BROKEN KEYS—ELECTRICALLY PERFECT  
1B3GT, 6H6, 6K6GT, 6SN7GT, 12SN7GT, each 50¢; 5 for \$2.00  
6BG6G, 6BQ6GT, 12S5GT, 198B6, 6L6GA, 6L6C, each 79¢; 3 for \$2.00

### TELEVISION COMPONENT BUYS

Hvoltage Condenser 500MFD 15KV . . . . . 65  
Hvoltage Condenser 500MFD 20KV . . . . . 75  
ION TRAP permanent magnet type . . . . . 79  
RG50 Cable per ft. . . . . \$5.98; 1M ft \$50.00  
300 copper twinex 100 ft \$1.80; 1M ft \$12.98  
TV Conical Antenna sturdy const. 72, 150, 300 ohm match. Incl. 8 elements & 100 ft of all copper twinex, cross bar & hardware. . . . . \$10.50  
Punch Stack Conical 16 elements, hardware cross bars, 100 ft. all copper twinex. . . . . \$10.50  
Write for TV tubing and low prices.

### MODEL HF-I OSCILLOSCOPE

Laboratory Features: 5 M C Bandwidth, 10M V Sens, PMV Horiz & Vert Amp, Cathode Coupled Multi Vib Swp., Int. Retrace, Cathode Pwr Inpt Vert & Horiz Amp, Non-Freq. Tics, Gain Control Cal Compensated Attenuator, Sync Pos or Neg, Intrnl or Externl, Inbuilt Cathode Filter for Sig. Tracing with Phones, 12" Tube line up, including 3BP1 CRT tube. Heavy duty construction, compact, with Tech Manual. Write for additional info.  
A "TAB" SPECIAL only \$99.50

### CIRCUIT BREAKER FUSE

PUSH TO RESET  
AMPS 3, 5, 7, 10, 15, 20. Fuses 27¢; 4 for \$1.00; 25 for \$5. Fuses with 2 Amps 31¢; 4 for \$1.25; 20 for \$5.98; 100 for \$25.00. 3AG size fuse operates up to 24V.

### CIRCUIT BREAKERS

Heinmann, Magn Hrs, Amps: 3, 5, 7, 9, 12, 15, 20, 30, 35, 40, 50, 60, 75, 100, 150, \$1.69 to \$15.98  
S&D & CH Toggle Sw Brkrs, Amps: 5, 10, 15, 20, 25, Each . . . . . 98c 10 for \$8.98

### STORAGE BATTERIES

36 Volt WILLARD Mini-BRAND NEW! 5 oz. Designed Portable Equip Model 152V . . . . . \$9.49  
6 Volt 40AH Willard ER40-6 . . . . . \$6.98  
2V 20AH Willard Plus Vibrator . . . . . 2.98  
5V 6AH Willard Plus Vibrator . . . . . 1.98  
Battery Acid (R-Exp) 1 pt. 59¢; 2 pts. . . . . 98  
Hydrometer 1.06 to 1.24 Sp Grav . . . . . 1.98

Prices Subject to Change  
Dept. 10 RE, 6 Church Street  
New York 6, N. Y., U. S. A.  
Cor. Church & Liberty Sts.  
Room 200, Phone Rector 2-6245

## ADVERTISING INDEX

Adelman, Nat	147
Adson Radio & Electronics Co.	143
Alliance Mfg Co.	145
Allied Electronic Sales	129
Allied Radio Corp.	17
Alma Radio	145
American Phenolic Corp.	110
Amperite Company, Inc.	129
Amplifier Corporation of America	139
Arday Radio Kits	129
Astron Corp.	99
Barry Electronics Corp.	146
Bass Radio & Television Corp.	118
Bendix Radio	120
Blonder-Tongue Labs.	87
Brooks Radio & Television Corp.	118
Candler System Co.	101
Capitol Radio Engineering Institute	101
Channel Master Corp.	22
Cisin, H. C.	113
Claroast Manufacturing Co., Inc.	138
Cleveland Institute of Radio Electronics	19, 20
Communications Equipment Co.	134
Concord Radio	86
Cornell-Dubilier Electric Corp.	98
Cornish Wire Co., Inc.	90
Coyne Electrical & TV Radio School	11, 139
Crest Laboratories, Inc.	138
Davis Electronics	142
DeForest's Training, Inc.	9
DeGray & Associates	147
Delco Radio	96
Electro Products Labs.	76
Electronic Beam Corp.	80
Electronic Instrument Co., Inc. (ETCO)	113
Electronic Measurements Corp.	130
Espey Manufacturing Co., Inc.	115
Feller Engineering Co.	90, 133
General Electric	98
General Industries Co.	100
General Test Equipment	101
Gonset Company	129
Gord, Inc., Don.	90
Grayburne Corp.	121
Greylock Electronic Supply Co.	113
Haldorson Co., The	143
Heath Co., Electrical Instrument Co.	59-69 Inclusive
Hickox Electric Co.	101
Hughes Aircraft Corp.	137
Hyrton Radio & Electronics Corp.	73
Illinois Research Labs.	115
Indiana Technical College	129
Instructograph Co.	98
International Assistance Co.	108, 109
Jackson Electronic Instrument Co.	93
Jan Electronic Distributing Co.	124, 145
Jensen Industries, Inc.	133
Jones & Laughlin Steel Corp.	82
LaPointe-Piascomol Corp.	83
Loctone Radio Corp.	136
Macmillan Company, The	142
Mallory & Co., Inc. P. R.	Inside Back Cover
McGraw-Hill Book Co.	144
Merrill Coil & Transformer Co.	12
Miles Reproducer Co., Inc.	101
Mosley Electric Co.	29
Moss Electronic Distributing Co., Inc.	113
National Electronics of Cleveland	120
National Radio Institute	3
National Schools	3
Ohmite Manufacturing Co.	106
Opportunity Adverts	133
Passmore Printing Co., Inc.	109
Philco Corporation	26
Pilot Radio Co.	127
Poly Tech.	111
Precision Development Corp.	111
Precision Apparatus Co., Inc.	116
Prentice-Hall, Inc.	132, 101
Pres-Probe Co.	100
Progressive Electronics Co.	97
RCA Institutes, Inc.	27
RCA Victor Division (Radio Corporation of America)	Inside Front Cover, Back Cover
Rafelco Manufacturing Co.	129
Radiart Corporation	71, 91, 101
Radio City Products	125
Radio Dealers	129
Radio Merchandise Sales, Inc.	105

## RADIO SCHOOL DIRECTORY

Page 145  
Commercial Radio Institute  
Martin School, Don  
Electronics Institute, Inc.  
Indiana Technical College  
Milwaukee School of Engineering  
RCA Institutes, Inc.  
Tri-State College  
Valparaiso Technical Institute  
Western Radio Television Institute

Radio-Television Training, Assn.	25
Ray Manufacturing Co.	137
Raytheon Company, Inc.	13
Regency Div. (I.D.E.A., Inc.)	112
Relay Sales, Inc.	123
Rider, Inc., Publisher, John F.	125
Rinehart Books, Inc.	134, 137, 147
Rohm Manufacturing Co.	144
Rose Company	117
Sams & Co., Inc., Howard W.	14, 104, 121
Sangamo Electric Co.	95
Schoff Co., Walter L.	100
Service Products Co.	100
Skyline Manufacturing Co.	122
Sprague Products Co.	15
Sprayberry Academy of Radio	57
Stan-Burn Radio & Electronics Co.	124
Standard Transformer Corp.	144
Standard Wood Products Corp.	92
Steve-El Electronics Corp.	92
Superior Instruments Co.	103, 123
Supreme Inc.	115
Supreme Publications	140
Sylvania Electric Products	140
TV Products Co.	140
Tab	146
Talbot, Co., Inc.	98
Tarzan, Inc., Sarkes	116
Tech-Master Products	136
Tel-A-Ray Enterprises, Inc.	9, 12
Telematic Industries, Inc.	102
Telesound Corp.	141
Television Communications Institute	136
Television Materials, Inc.	136
Telex, Inc.	143
Thomas Mold & Die Co.	101
Transvision, Inc.	130, 117
Triad Transformer Manufacturing Co.	134
Triod Manufacturing Co.	88, 89
Triplet Electronic Instrument Co.	10
Tung-Sol Electric Co.	10
Turner Co., The	18
Vee-P-K	83
Webster Electric Co.	107
Weller Electric Corp.	21
Wholesale Radio Parts Co., Inc.	120
Wincharger Corp.	124

Radio Electronics does not assume responsibility for any errors appearing in above index.

## New Listing Every Month TUBES

Standard R.M.A. Warranty. We endeavor to give you low, low prices, consistent with quality merchandise and service.

Here is only a partial listing of our large stocks. You may order popular types not listed at approx. same savings. Note Specials in Light-face type.

0A2 . . . . . 5	986BDE	86	12S17	75
0B2 . . . . . 1.10	6BB6	45	12SK7	75
0Z4 . . . . . 59	6BG6-G	1.60	12SL7	75
1A7GT . . . . . 58	6BY5-G	1.10	12SN7GT	87
1AE4 . . . . . 1.10	6C4	49	12SR7-M	75
1B3GT . . . . . 83	6CB6	45	25A5V	1.25
1L4 . . . . . 69	6F6-M	89	25BQ6-GT	79
1N21-B . . . . . 3.45	6F8-G	89	25L6-GT	65
1N23-A . . . . . 2.45	6G6-G	95	25Z6	75
1N23-B . . . . . 3.70	6J5GT	49	35B5	40
1N34 . . . . . 64	6J8	59	45C5	40
1N34-A . . . . . 75	6J7	75	35L6	69
1N44 . . . . . 1.21	6K6GT	66	35Z5-GT	55
1N45 . . . . . 1.39	6K7-M	76	35C5	50
1N54 . . . . . 89	6L5C	49	50L6-GT	55
1U4 . . . . . 49	6L6-GA	1.19	211	70
2B7 . . . . . 75	6L7	96	304-TL	8.00
2C43 . . . . . 15.95	6S7-M	98	304-TM	7.50
2D21 . . . . . 1.35	6SD7	75	717-A	98
2E24 . . . . . 2.75	6S7	86	805	2.50
2E30 . . . . . 2.19	6SH7	86	807	1.59
3A4 . . . . . 59	6SJ7-GT	69	811	2.80
3D6 1299 . . . . . 50	6SJ7-M	75	829	9.95
3E29 . . . . . 10.75	6SK7-GT	75	832	4.95
3Q4 . . . . . 49	6SL7-GT	60	832-A	8.50
3O5GT/G . . . . . 99	6SN7-GT	59	837	1.45
3S4 . . . . . 3.00	6T8	79	846-A	1.55
3CP1 . . . . . 8.00	6U4-GT	59	GE872-A	3.25
3FP7 . . . . . 1.95	6V6-GT	60	1280	80
3R4GY (RCA) . . . . . 1.29	6X5-GT	45	1613	7.75
3U4C . . . . . 59	6Y6-G	95	1614	2.25
3V4C . . . . . 1.25	7A6	65	1616	7.4
3X4C . . . . . 7.0	7A8	75	1619	3.0
3Y3GT . . . . . 85	7C7	80	1622(6L6)	1.95
5Z3 . . . . . 45	7H7	80	1625	40
6A4 . . . . . 85	1Z6A	65	1629	30
6A8 . . . . . 75	1Z8	79	1631	1.50
6AC7 . . . . . 98	1Z6H	75	1632	1.70
6AG5 . . . . . 70	1ZAT7	75	2050	1.48
6AH6 . . . . . 1.00	1ZAU7	59	5516	5.95
6AJ5 . . . . . 1.65	1ZAV6	55	5608-A	3.95
6AK5 . . . . . 75	1Z8A6	69	5812	2.00
6AK6 . . . . . 85	1Z8A7	90	5810	1.60
6AL5 . . . . . 2.50	1Z8B6	1.25	8008	4.95
6AN5 . . . . . 40	1Z8E6	45	9001	1.35
6AT6 . . . . . 70	1Z8A7	75	9002	1.80
6AU6 . . . . . 45	1Z8F5	70	9003	1.10
6AV6 . . . . . 55	1Z8G7	87	9004	3.9
6B8 . . . . . 65	1Z8H7	95	9006	3.9
6BC5 . . . . . 85				

## SELENIUM RECTIFIERS

Current (Continuous)	18/14 Volts	36/28 Volts	54/42 Volts	130/100 Volts
1 Amp.	\$1.25	\$2.10	\$3.60	\$8.95
2 Amps.	2.20	3.60	6.50	10.50
2 1/2 Amps.				13.00
4 Amps.	3.75	6.75	8.75	
5 Amps.	4.95	7.95	12.95	27.00
6 Amps.	5.50	9.00	14.00	36.00
10 Amps.	6.75	12.00	20.00	45.00
12 Amps.	8.50	16.00	25.50	52.50
20 Amps.	13.25	24.00	36.00	90.00
24 Amps.	16.00	31.00	39.50	98.00
30 Amps.	18.50	36.00		
36 Amps.	25.50	45.00		

### \* New Selenium Rectifier Transformers

PRI: 115 V., 60 cycles in } 4 Amps . . . . . \$ 8.75  
SEC: 9, 12, 18, 24, and 36 } 12 Amps . . . . . 16.75  
volts } 24 Amps . . . . . 35.75

Made to our specs for continuous heavy duty use

- 115V. PRI—36V. 55 amp second XFMR \$39.95
- 115V. PRI—5V. @ 100 Amp. SEC \$59.95
- 115 230 V 60 cy PRI SEC: 1.5, 30.5, 33.5, and 36.5V @ 4 AMPS. Herm. Sealed @ \$6.50

### • New Selenium Rectifier Chokes

- 4 Amps.—.07 hy.—.06 ohm . . . . . \$7.95
- 12 Amps.—.01 hy.—.1 ohm . . . . . \$14.35
- 24 Amps.—.004 hy.—.025 ohm . . . . . \$29.95

We can manufacture other Sel. Rec., Sel. Rec. Supplies, XFMRs., & Chokes. Write.

- Biley-Type SMC-100—Crystal Standards, 100 KC and 1,000 KC Bar . . . . . New \$8.50

### 5 lb. spools of finest rosin-core solder only . . . . . \$3.75

- ART-I—DeLuxe 75 Meter AM Mobile XMT—New—Complete . . . . . Only \$19.95
- AR II—Complete Station for 20, 40, 80, Sinterhet Revr—50 Watts CW w/built in AC Pwr Supply. New—in compact suitcase (orig. cost over \$500). An excellent buy for only . . . . . \$99.50
- Weston Meters, 0-100 micro amps, 2 1/2" Diam (Blank Scale) New Boxed. VERY Special \$5.95

Carter, 6 V. Dynamos, in original cartons.—590 VDC @ 150 ma. Only 7" x 4" x 3"—Special \$28.00.

# BARRETT ELECTRONICS CORP.

136 Liberty Street, N.Y. 6, N.Y. Rector 2-2563  
Terms: 5% with order, balance C.O.D.—Send a few cents for postage—All merchandise guaranteed. F.O.B. N.Y.C. \*Please, min. order \$25\*



# TUBES

Today's Best Buys

Top Quality at Terrific Savings  
**RTMA Guaranteed**

1A7GT	\$.79	6BA6	\$.55	7G7	1.30
1B3	.85	6BC5	.56	7H7	.70
1L4	.60	6BE6	.49	7N7	.90
1L5	.60	6BF5	.65	7Q7	.89
1L6	.95	6BF6	.70	7V7	.95
1N23B	3.50	6BG6	1.48	7W7	1.25
1N34	.69	6BH6	.75	12AT6	.40
1R5	.60	6BJ6	.65	12AT7	.80
1S4	.65	6BQ6	.94	12AU6	.55
1S5	.65	6C4	.60	12AU7	.60
1T4	.65	6CB6	.65	12AV7	.95
1U4	.60	6CD6G	1.33	12AX7	.75
1U5	.50	6E5	1.05	12BA6	.48
1X2A	.85	6H6M	.70	12BA7	.80
2D21	1.40	6J5M	.65	12BE6	.55
2X2	.60	6J6	.73	12J5GT	.50
3A4	.65	6K6	.65	12SA7GT	.70
3Q4	.55	6K7	.70	12SF5M	.65
3V4	.62	6L6G	1.05	12SJ7	.60
3S4	.80	6N7G M	.95	12SK7	.65
5U4G	.55	6S4	.51	12SQ7	.70
5V4	.95	6S7M	.85	12SN7GT	.75
5Y3GT	.39	6SA7GT	.70	12SR7	.65
5Z3	.85	6SC7	1.10	14B6	.95
6A7	1.00	6SG7	.75	19T8	.86
6AB4	.65	6SH7	.65	25AV5	.95
6AB5 6NS	1.25	6SJ7	.70	25L6GT	.60
6AC7	.95	6SK7GT	.53	25W4	.80
6AG5	.50	6SL7GT	.85	35L6GT	.53
6AG7	1.40	6SN7GT	.65	35W4	.47
6AH6	1.40	6SQ7GT	.65	35Z5GT	.49
6AJ5	1.45	6T8	.86	50A5	.80
6AK5	.95	6V6GT	.60	50B5	.53
6AK6	1.25	6W4GT	.49	50C5	.53
6AL5	.54	6X4	.39	50F6GT	.53
6AQ5	.65	6X5	.39	59	1.50
6AS5	.65	6Y6	.85	75	.85
6AT6	.45	7AD7	1.25	89Y	.75
6AU6	.65	7C5	.70	9001	1.25
6AV6	.50	7G7	.85	9002	1.05
6AX5GT	.85	7E7	1.30	9003	1.25
6B4	1.50	7F7	.95	9006	.35

Minimum Order \$15.00

**IMMEDIATE DELIVERY!**  
Write for quotations, many other types available. 20% deposit with order, balance C.O.D. All tubes subject to prior sale. Prices subject to change without notice.  
**WRITE, WIRE, CALL—TODAY!**  
We Buy Anything in Electronics—large or small quantities!

**Nat Adelman**  
168 Washington St. New York 6, N. Y.  
CO. 7-6091

## HI-GAIN TUNER-BOOSTER

LESS TUBES WITH DIAL

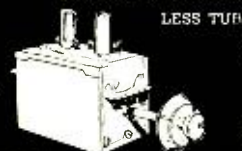

**\$4.75**

COMPLETE WITH TUBES

**\$6.00**

SOLVE POOR T. V. RECEPTION WITH A HI-GAIN BOOSTER. BANISH WEAK FRINGE AREAS, REDUCE SNOW. THIS UNIT COMES TO YOU AS A HIGHLY SERVICEABLE HIGH-GAIN TUNER. USES 6J6 TUBES IN VERY EFFICIENT HI-Q CIRCUIT. HAS 8 TUNED CIRCUITS USING PURE SILVER INDUCTANCES AND INDIVIDUAL COMPENSATION PROVIDING HIGH GAIN ON CHANNELS 7 TO 13. BUILT IN 5-1 VERNIER DRIVE. THIS IS A COMPLETE DEPARTURE FROM ORDINARY TUNERS.

ALL NECESSARY PARTS AND INSTRUCTIONS ARE INCLUDED TO CONVERT THIS UNIT IN A FEW MINUTES TO ONE OF THE HIGHEST GAIN BOOSTERS ON THE MARKET.

SEND FOR OUR NEW BULLETIN LISTING PICTURE AND RECEIVING TUBES, SPEAKERS AND MANY OTHER T. V. COMPONENTS AT TERRIFIC PRICE REDUCTIONS.

SHIPMENTS SENT POSTPAID WHEN FULL PAYMENT IS ENCLOSED WITH ORDER. 25% DEPOSIT ON C. O. D. SHIPMENTS. OPEN ACCOUNT PRIVILEGES TO RATED FIRM.

Dept. No. RE 10

# FRANK DE GRAY

AND ASSOCIATES

11842 W. JEFFERSON BOULEVARD  
CULVER CITY, CALIFORNIA

Please mention RADIO-ELECTRONICS when writing advertisers.

**THE SATURDAY REVIEW HOME BOOK OF RECORDED MUSIC AND SOUND REPRODUCTION**, by Edward Tatnall Canby, C. G. Burke, and Irving Kolodin. Published by Prentice-Hall, Inc., New York 11, N. Y. 6 1/2 x 9 1/2 inches, 308 pages. Price \$4.50.

The first 108 pages of this book are devoted to a complete and highly competent history of mechanical music reproduction, from the earliest cylinder and disc records of the '80's to present-day high-fidelity tape recording. The techniques and problems of modern record-making are described in a way that is clear to the non-technical music-lover and satisfactory to the audio engineer. Canby's contribution alone makes the book well worth reading.

The historical section is followed by a rather strange essay called "The Eclectic Phonograph." The key to it is given in the author's "intention to eschew the technical lingo of the trade, the purpose behind this book being enlightenment, not obfuscation. There is also the danger that behind the polysyllabic obscurant phrase lurks the fat proportionate price. . . ." Behind the polysyllabic obscurantism of this essay lies disappointment for the reader who hopes to get some idea of what equipment to buy and put together for a good phonograph, and why. The writer, stimulated by "the exuberance of his own vocabulary" into a world where knobs may be complacent, recording curves may reflect the results of sales conferences, signals have to be simplified into "sonic prototypes" and FM stations cannot interfere with each other, gives little help to either the earnest music lover or the audio technician. Fortunately, in a summary which is almost entirely composed of matter not found in the main essay, he lists components for five phonographs of varying excellence. The ensembles appear to be well chosen, and this part of the article is useful.

The third section of the book is solely for music lovers. It is called "Learning to Listen and Listening to Learn" and seems to be well handled.—FS END

Dozens of actual service case histories greatly simplify things and help make puzzling jobs easier to handle. Over 250 illustrations and pattern photos explain details step by step. Other subjects include component replacement data, wiring details, helpful hints on testing and a wealth of information on a broad range of subjects from fringe area reception to improving picture linearity in difficult locations.



Joe Buresch

"We can't take that route—it has two tunnels with only 12-foot clearance."

**Makes TV Servicing easier to learn!**

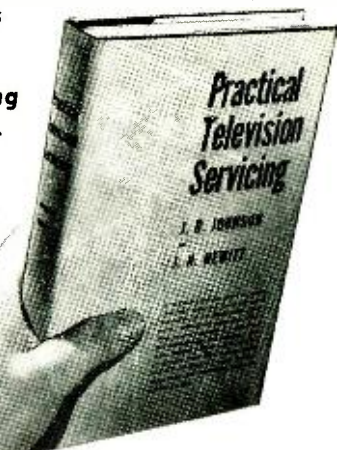

## THE BIGGEST \$4 WORTH IN TELEVISION TRAINING HISTORY!

**Practical, on-the-job data based on actual service shop experience**

**No involved mathematics!** No confusing theory! The two well-known engineers who wrote PRACTICAL TELEVISION SERVICING actually operated a TV service shop to get the specific, down-to-earth information they now pass along to you in easily understood form. They show exactly how to troubleshoot, diagnose and repair television troubles; how to locate troubles quickly with less testing; how to make repairs fast and more profitably.

**HELPS YOU PASS SERVICE LICENSE EXAMS!**

Now pending in many places, are new laws requiring service men to pass stiff tests. Let Practical Television Servicing equip you with the "know how" to pass these exams with flying colors!

**GASH IN ON TV SERVICE PROFITS**

Lots more TV stations are scheduled to operate this year in new areas. Get in "on the ground floor" for the profitable new service business that will result!

**TELLS WHAT TO DO —HOW TO DO IT!**

Dozens of actual service case histories greatly simplify things and help make puzzling jobs easier to handle. Over 250 illustrations and pattern photos explain details step by step. Other subjects include component replacement data, wiring details, helpful hints on testing and a wealth of information on a broad range of subjects from fringe area reception to improving picture linearity in difficult locations.

**READ IT 10 DAYS ... at our risk!**

Dept. RE-102, RINEHART BOOKS, Inc., Technical Division, 232 Madison Ave., New York 16, N. Y.

Send PRACTICAL TELEVISION SERVICING for 10-DAY EXAMINATION. If I decide to keep the book, I will then remit \$4.00 plus a few cents postage. Otherwise, I will return book postpaid and owe you nothing.

Name \_\_\_\_\_

Address \_\_\_\_\_

City, Zone, State \_\_\_\_\_

Employer's Name & Address \_\_\_\_\_

OUTSIDE U.S.A.—Price \$4.50 cash only. Money back if book is returned in 10 days

*to the E. E. or PHYSICS GRADUATE*

*with experience in*

## **RADAR OR ELECTRONICS**

*Hughes Research and Development Laboratories,  
one of the nation's large electronics organizations, is now  
creating a number of new openings  
in an important phase of its operation.*



*Here is what one of these positions offers you:*

### **1. THE COMPANY**

Hughes Research and Development Laboratories is located in Southern California. We are presently engaged in the development of advanced radar devices, electronic computers and guided missiles.

### **2. THE NEW OPENINGS**

The positions are for men who will serve as technical advisors to the companies and government agencies purchasing Hughes equipment. Your specific job would be to help insure the successful operation of our equipment in the field.

### **3. THE TRAINING**

Upon joining our organization,

you will work in our Laboratories for several months until you are thoroughly familiar with the equipment you will later help the Services to understand and properly employ.

### **4. WHERE YOU WORK**

After your period of training (at full pay), you may (1) remain with the company Laboratories in Southern California in an instruction or administrative capacity, (2) become the Hughes representative at a company where our equipment is being installed, or (3) be the Hughes representative at a military base in this country—

or overseas (single men only). Compensation is made for traveling and for moving household effects, and married men keep their families with them at all times.

### **5. YOUR FUTURE**

You will gain all-around experience that will increase your value to the company as it further expands in the field of electronics. The next few years are certain to see a large-scale commercial employment of electronic systems—and your training in the most advanced electronic techniques now will qualify you for even more important positions then.

### **HOW TO APPLY**

If you are under thirty-five years of age, and if you have an E. E. or Physics degree, with some experience in radar or electronics,

write to:

## **HUGHES**

**RESEARCH AND DEVELOPMENT LABORATORIES**

*Engineering Personnel Department*

CULVER CITY, LOS ANGELES COUNTY, CALIFORNIA

*Assurance is required  
that relocation of the applicant will not cause  
disruption of an urgent military project.*



# Why take a chance?

Some people make their living by taking chances. But you must make your living by earning customer satisfaction—so why take chances by ordering capacitors by rating only? Order by rating *and* brand!

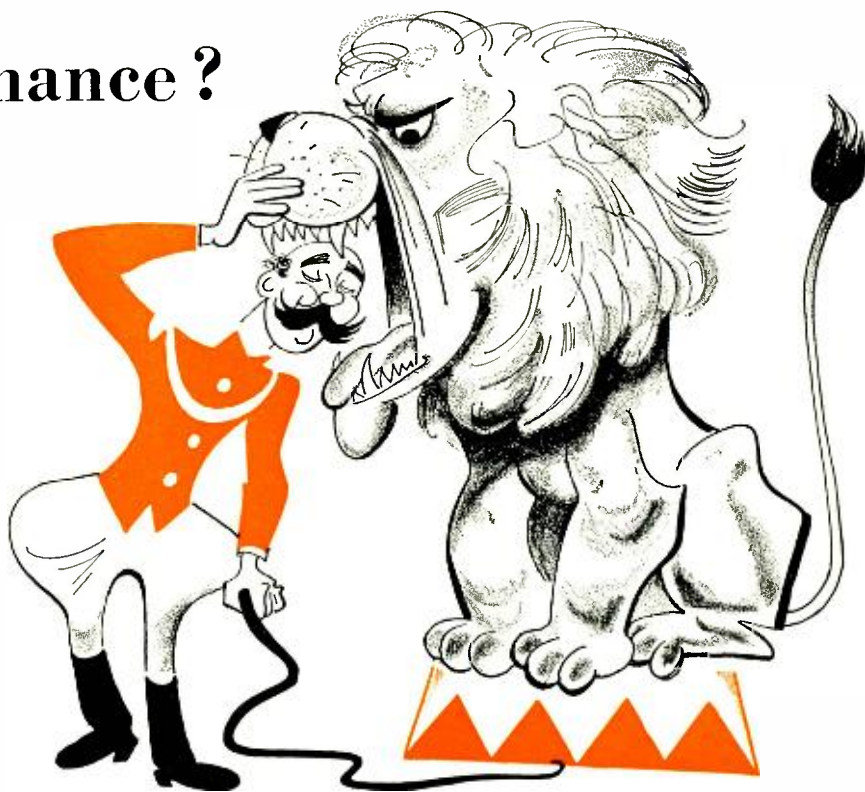

## Make Sure! Make it Mallory!

Customer satisfaction with your service pays off in repeat business . . . word-of-mouth advertising . . . cash in the bank. You can build it by using Mallory capacitors on all your service work.



Top-notch TV and radio set makers accept Mallory FP's as *the* standard of capacitor quality. You get longer life even with higher temperatures and greater ripple current . . . dependable operation even at 185° F. (85° C.).



Mallory Plascaps\* leave ordinary plastic tubulars far behind! Dependable performance . . . no leaks . . . no premature "shorts" . . . no off-center cartridges . . . and no unsoldered leads. It will pay you to use Mallory Plascaps—the first completely engineered plastic tubular!

Back of every Mallory capacitor is the knowledge and experience gained in 25 years of research and development work. Mallory produced the first dry electrolytic capacitor...pioneered in making smaller, longer-lasting capacitors with outstanding heat-resistant qualities. There's just no sense in taking chances on capacitor performance. Always be sure . . . always order Mallory capacitors for all your service work.

*Depend on your Mallory Distributor for quality products at competitive prices.*

P. R. MALLORY & CO. Inc.  
**MALLORY**

CAPACITORS • CONTROLS • VIBRATORS • SWITCHES • RESISTORS  
• RECTIFIERS • VIBRAPACK\* POWER SUPPLIES • FILTERS

**APPROVED PRECISION PRODUCTS**

**P. R. MALLORY & CO., Inc., INDIANAPOLIS 6, INDIANA**

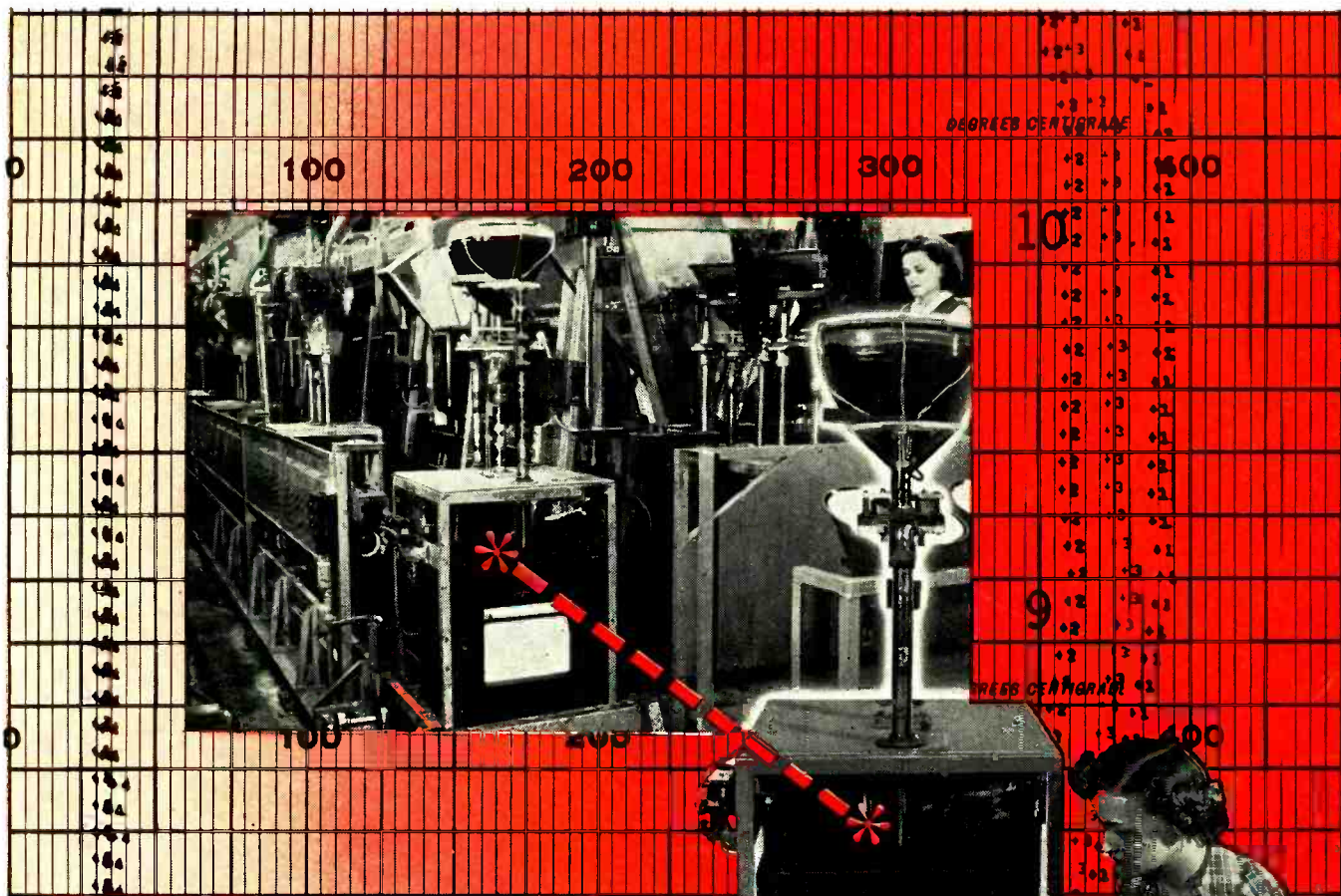

# The guinea pig that "runs a fever"

## to bring you better picture tubes

IN THE straight-line exhaust systems used at RCA picture-tube plants, each picture tube rides through a long oven on its own "exhaust cart." As the tube passes through this oven, the envelope is freed of gas by baking it at high temperatures.

These high temperatures must be carefully controlled for each picture tube type, and held to rigidly prescribed limits, in order to avoid setting up harmful strains in the glass, especially at the faceplate and wall of the tube.

Here is where the "electric guinea pig" comes in. The "guinea pig" actually consists of a sample tube, with five thermocouples attached to its outside surfaces. These thermocouples are connected to an instrument known as a recording pyrometer. At intervals during the day, this "guinea pig" travels through the oven, and emerges with a complete and accurate "fever chart" for the particular tube type in production. In this manner, temperature deviations are quickly spotted . . . and promptly corrected.

This is another example of the care exercised in the manufacture of RCA picture tubes. Through constant vigilance, RCA closely guards its own reputation for quality . . . and yours as well.

With RCA Receiving Tubes, as well as RCA Kinescopes, **TOP-QUALITY CONTROL** makes the difference.



**RADIO CORPORATION of AMERICA**  
ELECTRON TUBES

HARRISON, N. J.

TMKS. ®



# ADV Plans, LLC

## Copyright Notice:

The entire contents of this CD/DVD are copyright 2014 by ADV Plans, LLC. All Rights Reserved.

Reproduction or distribution of this disk, either free or for a fee is strictly prohibited. We actively monitor and remove listings on eBay thru Vero.

You are free to copy or use individual images in your own projects, magazines, brochures or other school projects.

Only the sellers listed here are authorized distributors of this collection:  
[www.theclassicarchives.com/authorizedsuppliers](http://www.theclassicarchives.com/authorizedsuppliers)

Please view our other products at  
[www.theclassicarchives.com](http://www.theclassicarchives.com),  
or our ebay stores:

[TheClassicArchives](#)  
[ADVPlans](#)  
[SuperShedPlans](#)

